

Assembly Instructions

Caution: You must read this before you proceed

Arm Chair

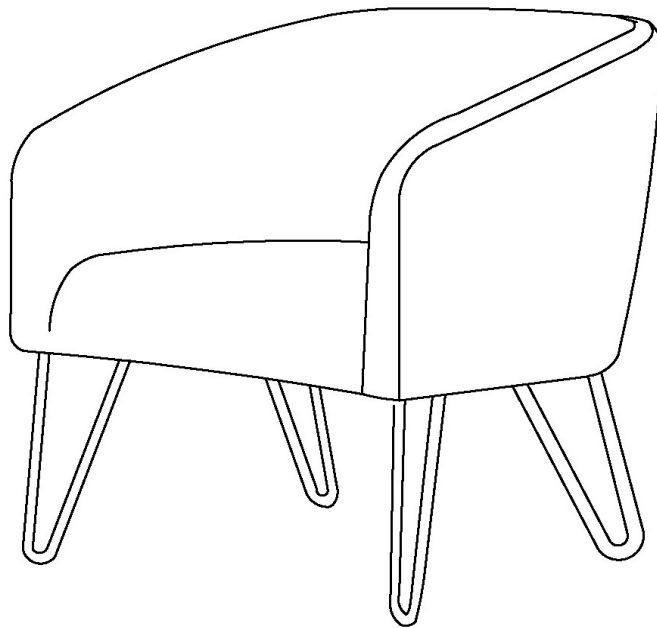



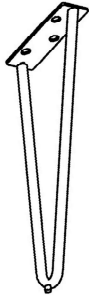

Parts List

Label	Picture	Description	QTY
A	A line drawing of the chair seat, showing its curved shape and the front edge.	Chair Seat	1
B	A line drawing of a single front leg, showing its double-line design and the mounting holes at the top.	Front Leg	2

C		Back Leg	2
---	---	----------	---

Hardware

Label	Picture	Description	QTY
①		Bolt (M6*19mm)	13
②		Spring Washer	13
③		Washer	13
④		Allen Key	1

Assembly Preparation

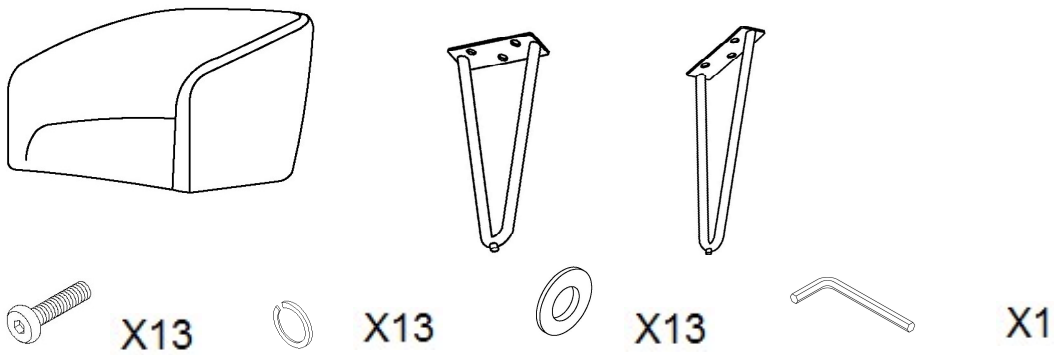
<p>Before Beginning Assembly:</p>				
-----------------------------------	--	--	--	--



- Read instructions, cover to cover-



- Have 2 adults on hand for assembly-



- Do not assemble on flooring or carpet-



- Assemble on a clean non-marring surface (packing foam)-



- Save all packaging until finished-

Assembly Steps

Overview

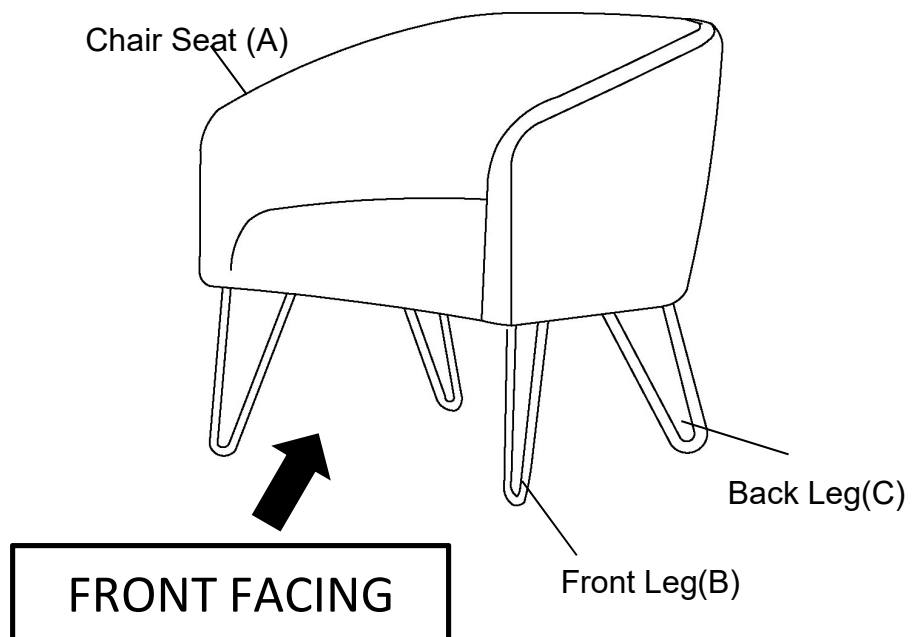

This Arm Chair has multiple parts and may require up to 30 minutes to assemble. To give you an overview of the Arm Chair, the above picture is to help you put the various parts into perspective. Please read through the instructions below to familiarise yourself with the parts and steps before assembly.

Step 1

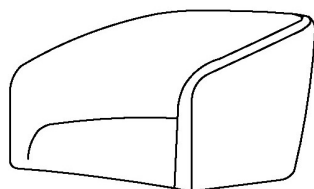

A

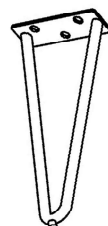

B

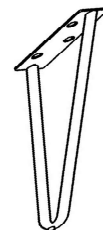

C

Place the Chair Seat (A), Front Legs (B) and Back Legs (C) onto a clean, non-marring surface.

Step 2

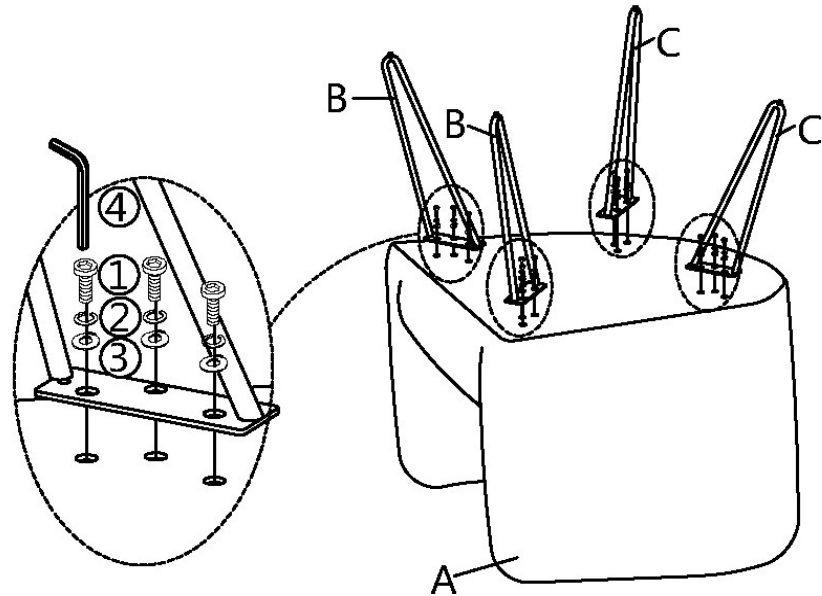

Turn over the Chair Seat(A), attach the Front Legs (B) and the Back Legs (C) to the bottom of the Chair Seat(A) using Bolts(①), Spring Washers(②) and Washers(③) with the Allen Key(④) as shown above.

Step 3

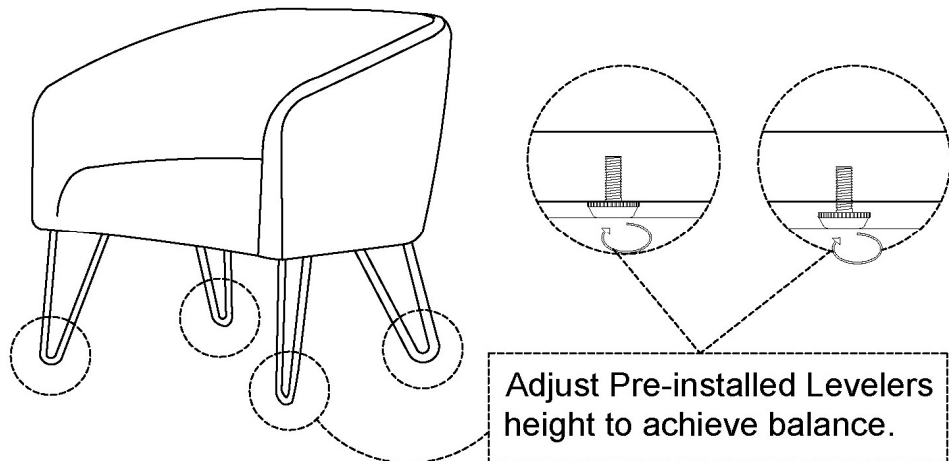





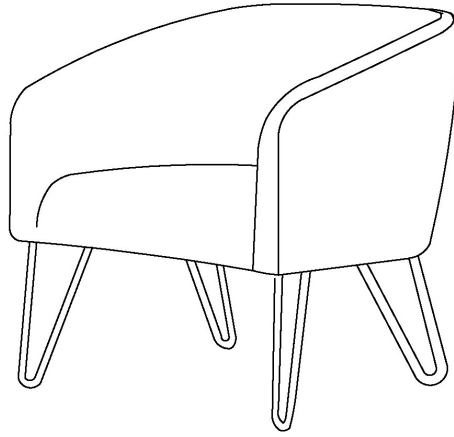





Place the Arm Chair on a Level Surface , adjust the Pre-installed Levelers at the bottom of the Front Legs (B) and the Back Legs (C) until the Arm Chair is level with the ground.

Step 4



Your Arm Chair is ready for use.
This Arm Chair can only be used on a flat, level surface.

Care & Maintenance

	<ul style="list-style-type: none">● Furniture may scratch floors. We recommend using furniture pads to protect your floors.
	<ul style="list-style-type: none">● Do not put hot items directly on furniture surface.
	<ul style="list-style-type: none">● Do not clean furniture with harsh cleansers or polish.
	<ul style="list-style-type: none">● Do not place furniture under direct sunlight.
	<ul style="list-style-type: none">● Do not place furniture near heating or cooling vents.
	<ul style="list-style-type: none">● Do not write on furniture without a padded barrier to protect the surface.
	<ul style="list-style-type: none">● Do not place furniture outside . For indoor use only.
	<ul style="list-style-type: none">● Not for commercial use. For residential use only.
	<ul style="list-style-type: none">● Stains may be removed with mild soap solution and damp cloth.
	<ul style="list-style-type: none">● Children should not climb or jump on the furniture.
	<ul style="list-style-type: none">● Dust and pick-up spills using a clean, non-colored, lint-free cloth.