

WARNING

**** WE RECOMMEND INSTALLATION OF THIS LIGHTING FIXTURE BE DONE BY A LICENSED ELECTRICIAN ****

- * Switch off the main electrical supply from the main fuse box / circuit breaker before installation.
- * Inspect item carefully before attempting to install.
- * If there is any damages or obvious defects, do not install.
- * Item may not be returned once it has been installed.













CARE AND MAINTENANCE

- * To clean the outside of the fixture, use a dry or slightly dampened clean cloth (use clean water, never a solvent) to wipe the surface of the fixture.
- * To clean the inside of the fixture, first disconnect power to the fixture by turning off the circuit breaker or by removing the fuse at the fuse box. Next, use a dry or slightly dampened clean cloth (use clean water, never a solvent) to wipe the interior surface of the fixture.
- * Do not use any cleaners with chemical, solvents or harsh abrasives. Use only a dry soft cloth to dust or wipe carefully.

NOTICE& IMPORTANT SAFETY INSTRUCTIONS

- * Please make sure that you have all parts indicated before you begin assembly of this item
- * This item should be assembled on a soft surface to prevent scratching the finish during assembly
- * To reduce the risk of fire, electrical shock or injury to persons or property, please follow the guideline below for safe use and installation
- *The external flexible cable or cord of this lamp cannot be replaced
If the cord is damaged, the lamp shall be destroyed

Part List and Hardware List

PIECE	DESCRIPTION	PICTURE	QUANTITY	PIECE	DESCRIPTION	PICTURE	QUANTITY
A	Mounting Plate		1X	H	Finial		1X
B	Wire Nut		3X	I	Gasket		1X
C	Mounting Screw		2X	J	Cover		1X
D	Lamp Body		1X	K	Shade		1X
E	Canopy Nut		2X	L	Nut		1X
F	Ground Screw		1X	M	Bulb		2X
G	Tube		1X				

Product Dimensions: 16"L X 16"W X 8.5"H

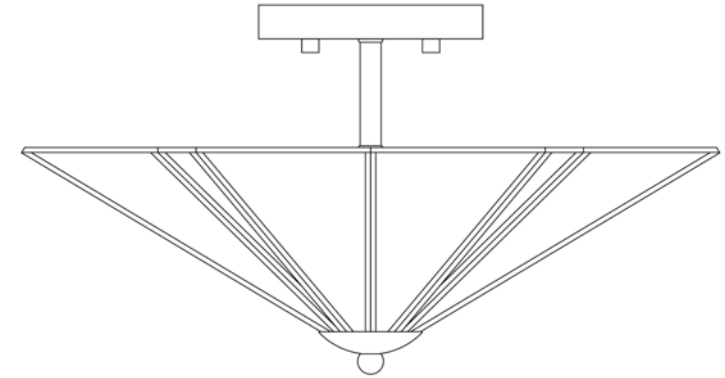

PREPARATION

- * Before beginning assembly of product, make sure all parts are present. Compare parts with package contents list and hardware contents list.
- * If any part is missing or damaged, do not attempt to assemble the product.
- * Estimated Assembly Time: 20 minutes.

PLEASE USE TYPE "B" BULB MAX 40-WATT OR CFL BULB MAX 13-WATT OR LED MAX 9-WATT. THERE ARE 2 X 4W LED BULBS IN THE BOX.

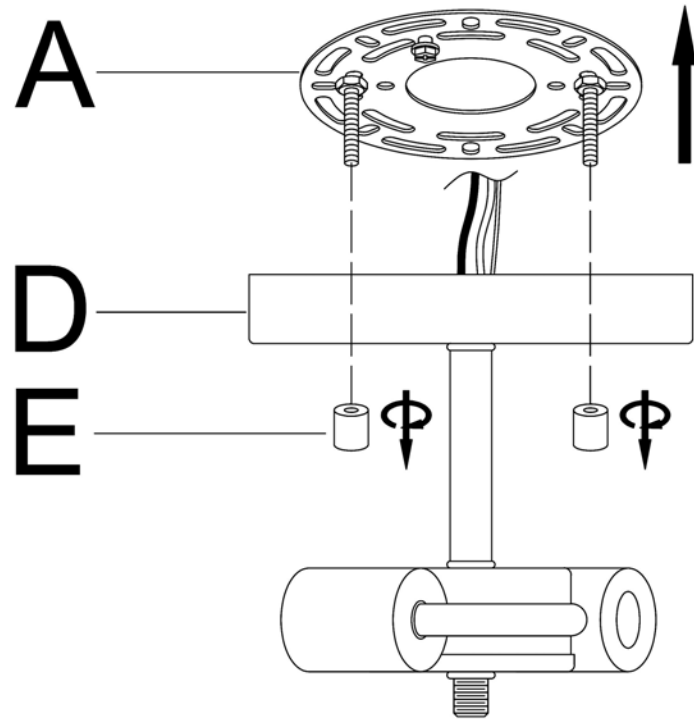

Step 1: Unpack all parts from cartons carefully. Turn the Canopy Nut (E) counterclockwise to separate the Mounting Plate (A) and Lamp Body (D).

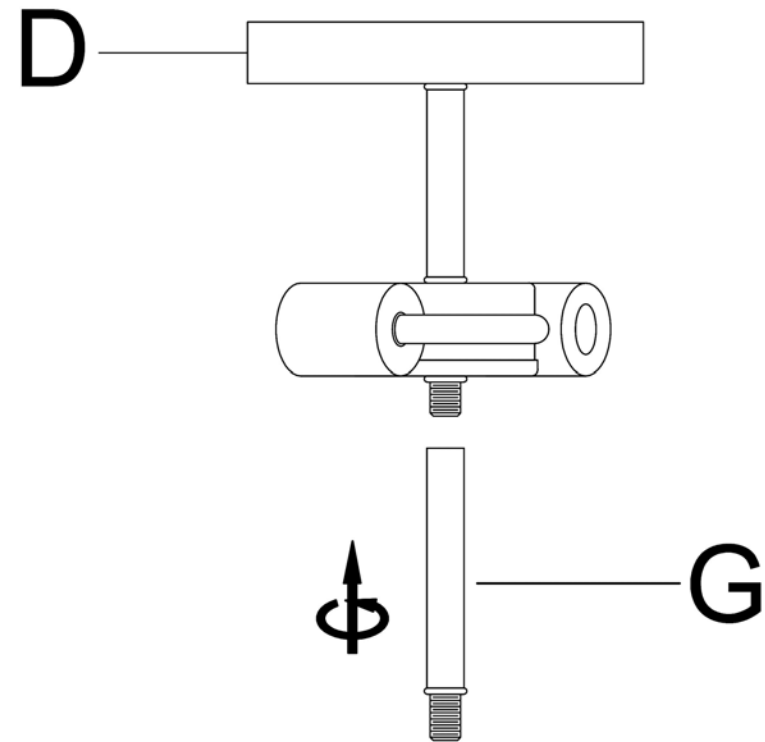

Step 2: Fix one end of Tube (G) to the Lamp Body (D) in a clockwise direction.

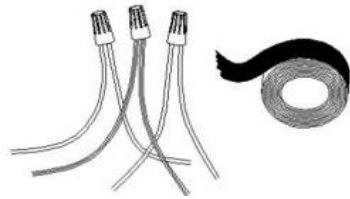
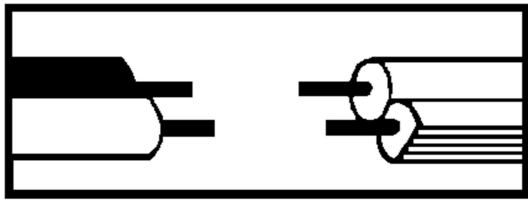

Step 3: Wire connection

Connect fixture neutral wire (ribbed) to the outlet box neutral wire (usually white) using a wire nut. Connect fixture hot wire (smooth with markings) to the outlet box hot wire (usually black) using a wire nut.

CAUTION: Do not reverse the hot and neutral connections

Grounding Instructions:

Wrap ground wire from outlet box around green ground screw on mounting Plate (A), no less than 2" from wire end. Tighten ground screw. If fixture is supplied with a ground wire, connect to outlet ground wire with a wire connector.

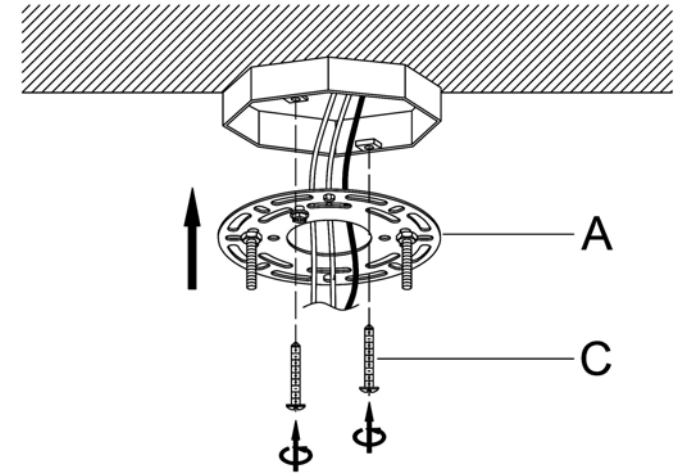

Step 4: Fix the Mounting Plate(A) to the junction box with Mounting Screw (C).

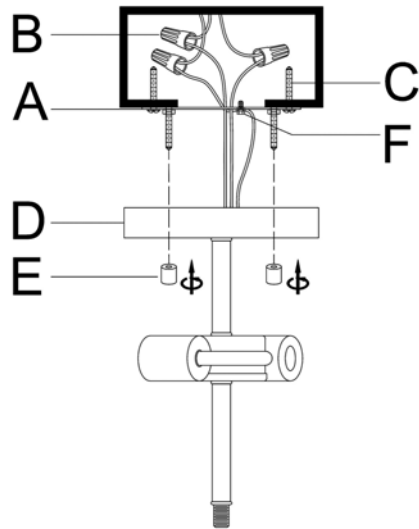

Step 5: Attach the Lamp Body(D) to the junction box and fix it by turning the Canopy Nut(E) clockwise.

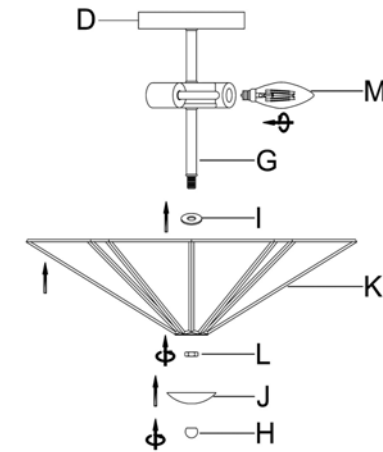

Step 6: Insert the Bulbs (M) into the Sockets as diagram. Set the middle hole of the Gasket (I) and Shade (K) into the threaded part of the Tube (G), turn the Nut (L) clockwise to be tightened, then set the Cover (J) into the threaded part of the Tube (G), turn the Finial (H) until tightened.