

SINGLE CHAIR

ASSEMBLY INSTRUCTIONS

IMPORTANT:

Please read all the instructions and warnings before assembling.

WARNING:







- **All bolts shouldn't be tightened until the complete piece is assembled (This will make the assembly process much easier). Once the piece is fully assembled, then go back and tighten all bolts with provided tool.**
- Keep all children and pets away from assembly area.
- Keep assembly area at least 6 feet from any obstruction such as a fence, garage, house, overhanging branches, laundry line or electrical wires.
- Some parts may contain sharp edges. When assembling and using this product, basic safety precautions should always be followed to reduce the risk of personal injury and damage to the product.
- The chair is not to be used for standing purposes and will not function as a stool or step-ladder. Use on even surfaces only.
- The chair is not a toy. Proper use of the chair is for single person seating only. Chair tested for use at weight of 250 lb . Improper use of this product or failure to use as directed may result in injury. Not intended for commercial use.
- **Warranty:** One year limited warranty. Proof of purchase (dated register receipt) is required for warranty claims. It remains the customer's responsibility for freight and packing charges to and from the service center.

CARE & MAINTENANCE

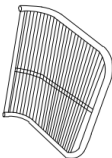
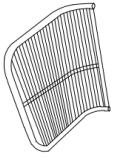
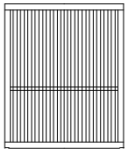
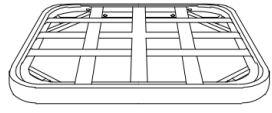
- **STAIN RESISTANT CUSHIONS CARE — KEEP THE CUSHIONS IN STORAGE ON RAINY DAYS.**
- **SPILLS:** Immediately wipe up the spill using a white damp cloth. Repeat process if necessary until stain is gone. Allow cushion to air dry.
- **FABRIC CARE:** Hand wash cold, non-chlorine bleach when needed, lay flat to dry. Cool iron if necessary. Do not dry clean.
- **ALL WEATHER WICKER PRODUCT CARE**

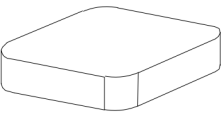
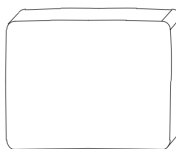
When not in use, wipe free of any dirt or loose objects, wash with a mild solution of soap and water, rinse thoroughly and dry completely. Do not use strong detergent or abrasive cleaners. Bolts can loosen over a period of usage, please check the bolts occasionally and re-tighten if necessary.

ASSEMBLY INSTRUCTIONS

Part No.	Part	Qty	Image	Part No.	Part	Qty	Image
A1	Left Arm	1		A2	Right Arm	1	
B	Back	1		C	Seat Panel	1	
D	Leg	4		E	Seat Cushion	1	
F	Back Cushion	1		G	Bolt 1 M6*35mm	10	
H	Bolt 2 M6*15mm	12		I	Washer Ø16*Ø6.5*1mm	22	
J	Allen Wrench	1					

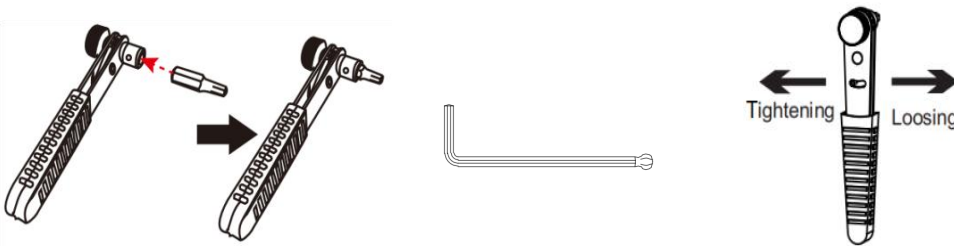

1. Keep the bolts fully tightened.

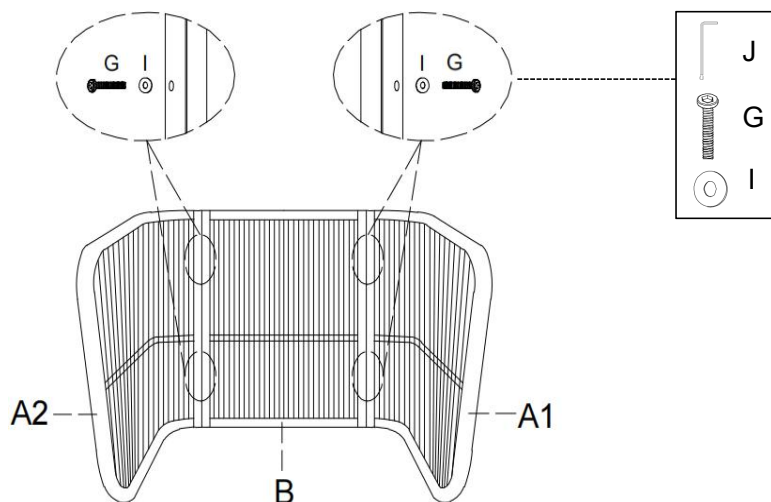

2. Keep the bolts loose.

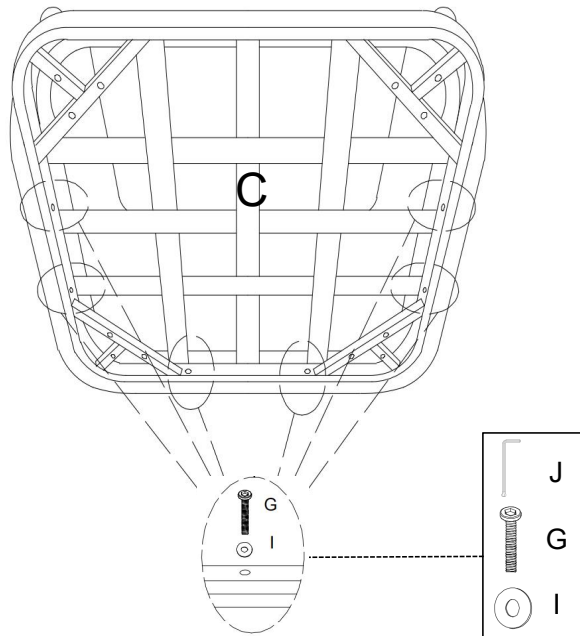

3. Keep the bolts loose.

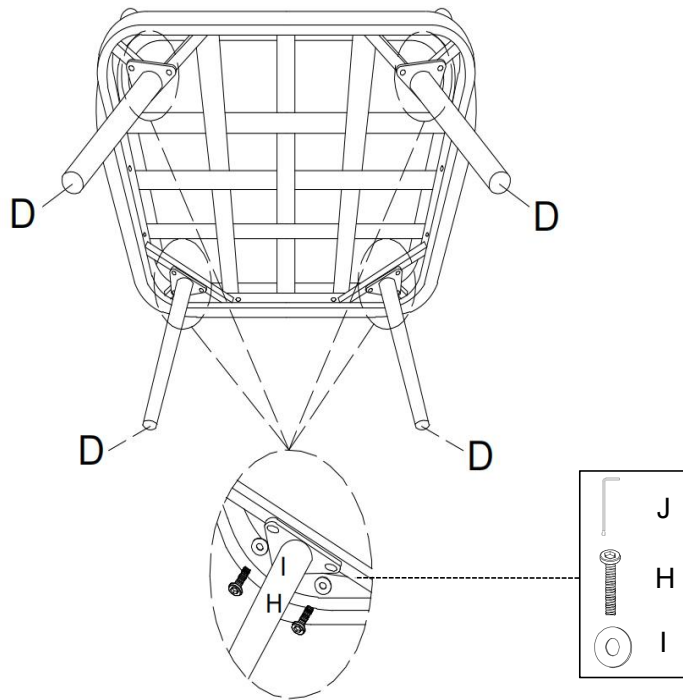

4. Tighten all bolts, put cushions onto the chair.

