

# Assembly Instruction of Extra Large Kitchen Cart

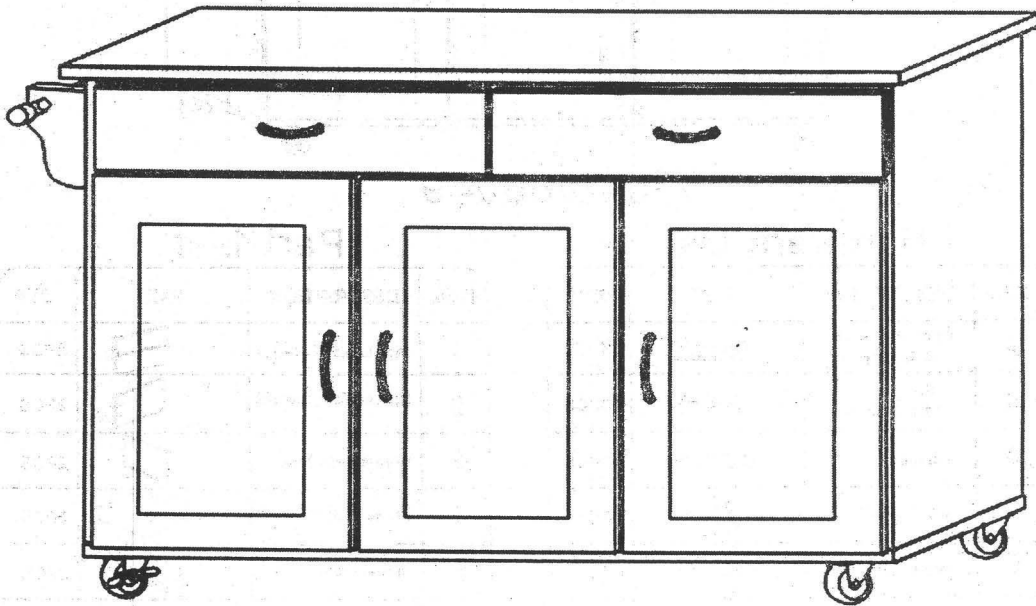

**Note:**

- 1) Please be advise to have at least 2 persons to assemble this unit
- 2) Tools not included, but essential for assembling this unit:

"Philips" Screwdriver

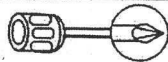





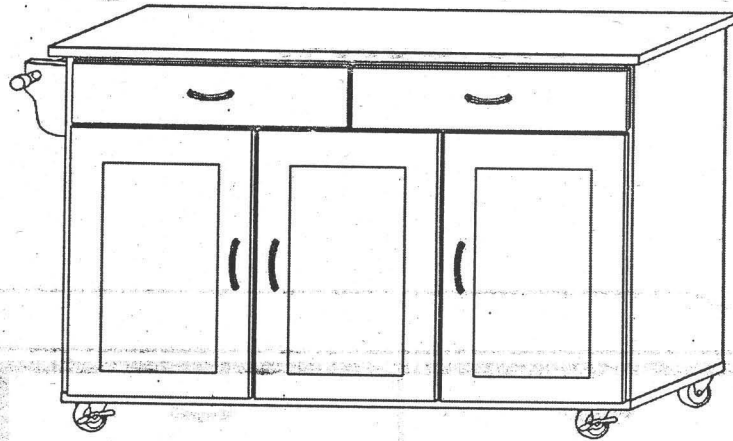





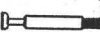













- 3) Place a large cloth or blanket on the floor or flat surface to protect parts from scratching
- 4) Before assembling this unit, please check that all parts and hardware are present















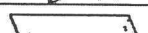

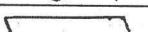

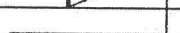

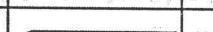
**Made in China**

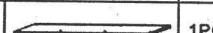

### Hardware List

| ITEM | DESCRIPTION                 | PART                                                                                | QTY   |
|------|-----------------------------|-------------------------------------------------------------------------------------|-------|
| A    | Wooden Dowel<br>(Φ 6*30mm)  |    | 34PCS |
| B    | Screw<br>(Φ 3.5*30mm)       |    | 10PCS |
| C    | Long Bolt                   |    | 14PCS |
| D    | Big Camlock                 |    | 4PCS  |
| E    | Short Bolt                  |    | 4PCS  |
| F    | Small Camlock               |    | 14PCS |
| G    | Handle                      |  | 5PCS  |
| H    | Handle bolt                 |  | 10PCS |
| I    | Drawer Stopper              |  | 4PCS  |
| J    | Screw<br>(Φ 3.5*12mm)       |  | 24PCS |
| K    | Screw<br>(Φ 3.5*35mm)       |  | 10PCS |
| L    | Castor Screws<br>(Φ 5*15mm) |  | 16PCS |
| M    | Shelf pin                   |  | 12PCS |
| N    | Left Hinges                 |  | 2PCS  |
| O    | 3"castor with Brake         |  | 2PCS  |
| P    | 3"castor w/o Brake          |  | 2PCS  |
| Q    | Screw<br>(Φ 3*12mm)         |  | 16PCS |
| R    | Plastic Runner              |  | 2PCS  |
| S    | Wooden Dowel<br>(Φ 8*30mm)  |  | 4PCS  |
| T    | Allen Wrench                |  | 1PC   |
| U    | Allen Bolt                  |  | 4PCS  |
| V    | Magnetic Catch              |  | 3PCS  |
| W    | Metal Bar                   |  | 3PCS  |
| X    | Right Hinges                |  | 4PCS  |

### Part List

| ITEM | DESCRIPTION          | PART                                                                                  | QTY  |
|------|----------------------|---------------------------------------------------------------------------------------|------|
| 1    | Drawer Side Panel(L) |    | 2PCS |
| 2    | Drawer Side Panel(R) |    | 2PCS |
| 3    | Drawer Back Panel    |    | 2PCS |
| 4    | Drawer Bottom Panel  |    | 2PCS |
| 5    | Drawer Front         |    | 2PCS |
| 6    | Right Panel          |    | 1PC  |
| 7    | Drawer divider       |  | 1PC  |
| 8    | Left Panel           |  | 1PC  |
| 9    | knife Rack           |  | 1PC  |
| 10   | Front Cross Bar      |  | 1PC  |
| 11   | Top Panel            |  | 1PC  |
| 12   | Upper Shelf Panel    |  | 1PC  |
| 13   | Rack support         |  | 2PCS |
| 14   | Tower Rack Bar       |  | 1PC  |
| 15   | Left Middle Panel    |  | 1PC  |
| 16   | Upper Back Panel     |  | 2PC  |
| 17   | Lower Back Panel     |  | 3PC  |
| 18   | Bottom Panel         |  | 1PC  |
| 19   | Adjustable shelf     |  | 3PC  |
| 20   | Left Door            |  | 1PC  |
| 21   | Right Door           |  | 2PC  |
| 22   | Right Middle Panel   |  | 1PC  |

## STEP 1

# Drawer Assembly Instruction

### Assembly of camlock

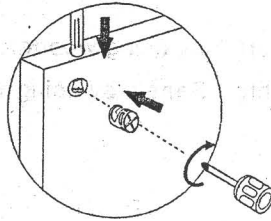
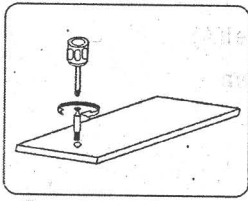

Screw camlock bolt to wood part

Do not tighten camlock unless is instructed

To assemble camlock, ensure long side of the + is facing the bolt before inserting into hole

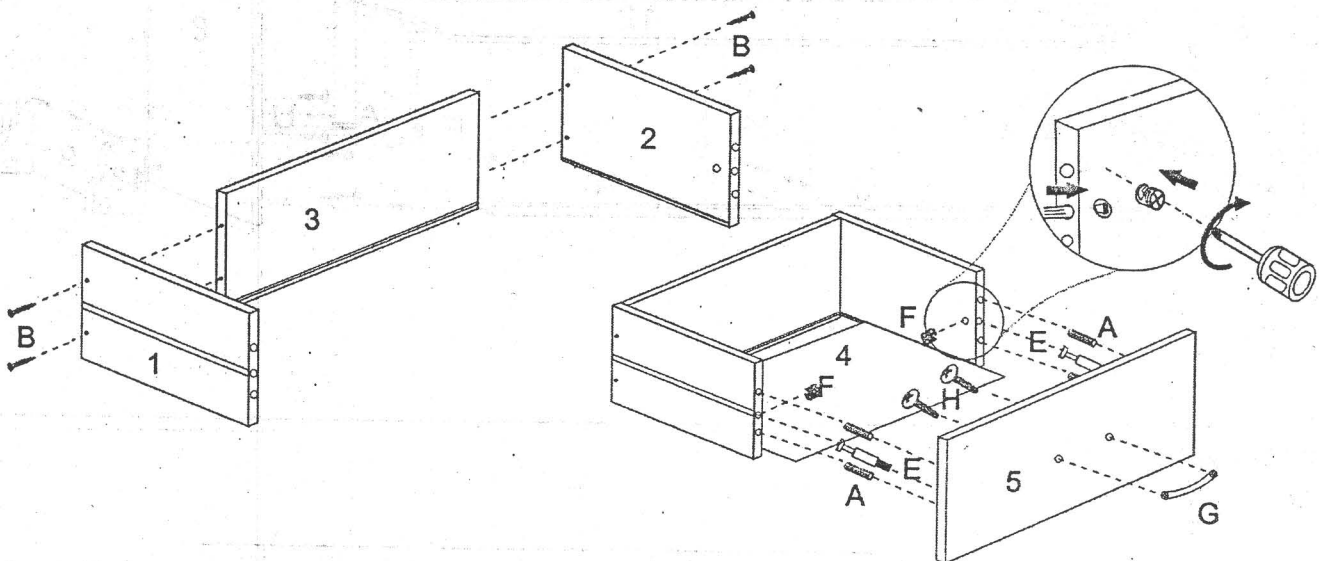

Assemble Drawer Side panel(1) and Drawer Side Panel R(2) to the Drawer Back Panel(3) By using Screws(B).  
Install Short Bolt(E), Wooden Dowel(A) and Small Camlock(D) to Left & Right Drawer Side as shown.  
Install the handle(G) to Drawer Front(5) by using Handle Bolt(H).

## STEP 2

Assemble Plastic Runner(R) to Right panel(6), Left panel(8) by using screws(Q).

Assemble Rack support(B) to Knife Rack (9) by using Wooden Dowel(s).

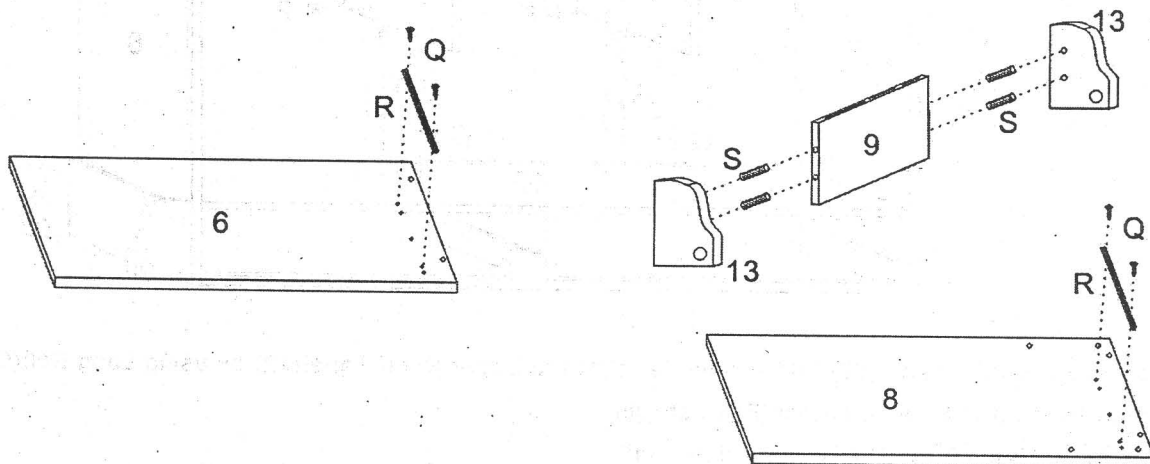

### STEP 3

Assemble the Knife Rack Support to Left panel(8) by using Allen Bolt(U).

Assemble Front Cross Bar(10) to both Left(8) and Right(6) Panels by using wooden dowel.

Assemble Upper Shelf Panel(12) to Drawer Divider(7) by using wooden Dowel(A) and screw(K),then assemble with Left(8) and Right(6) Panels by using wooden Dowel(A),Long Bolt(C) and Small Camlock(F).

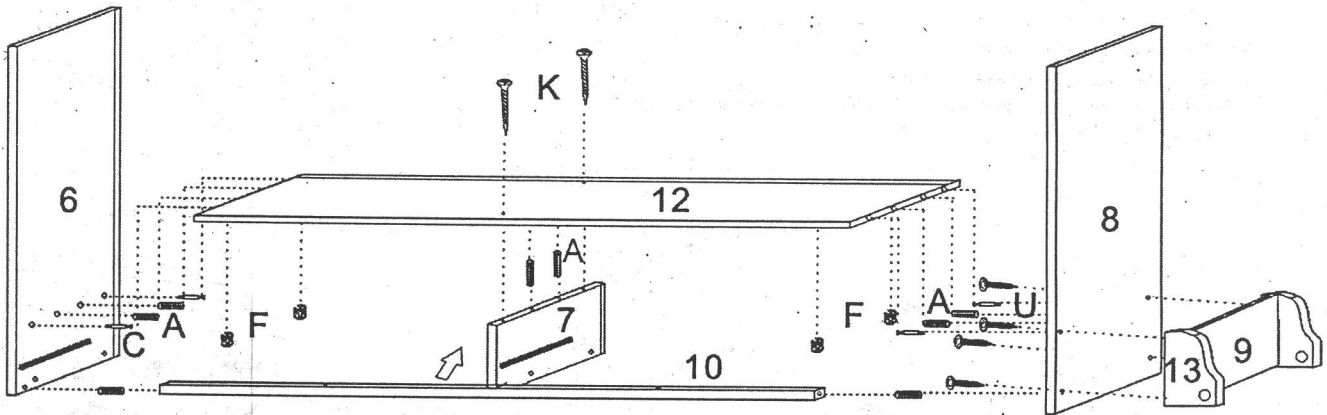

### STEP 4

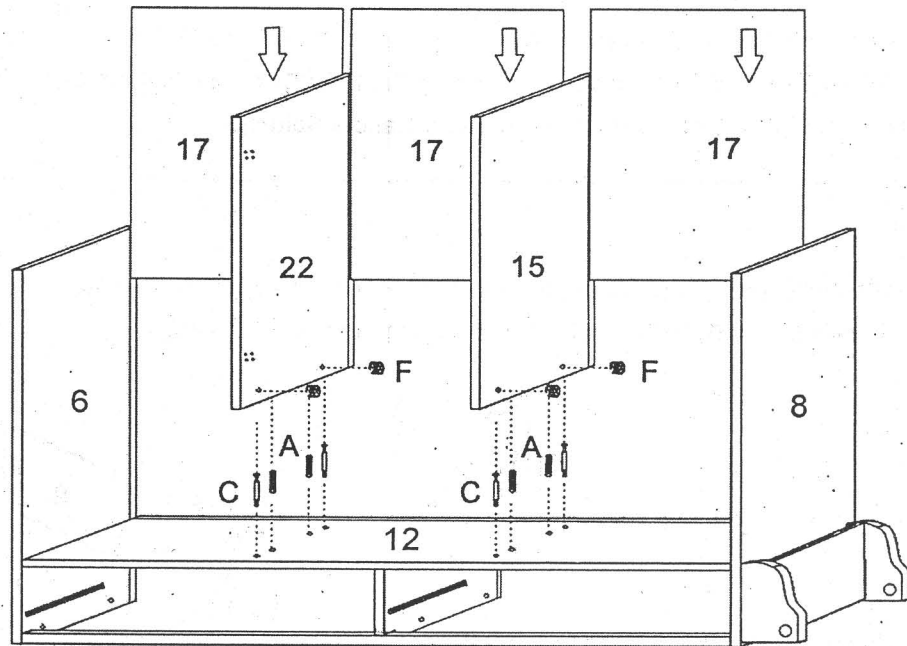

Assemble Right Middle panel(22),Left Middle Panel(15) to Upper Shelf Panel(12) by using Long Bolt(C), Wooden Dowel(A) and Small Camlock(F) as shown.

Insert the Lower Back Panel(17)to Assembled Unit.

## STEP 5

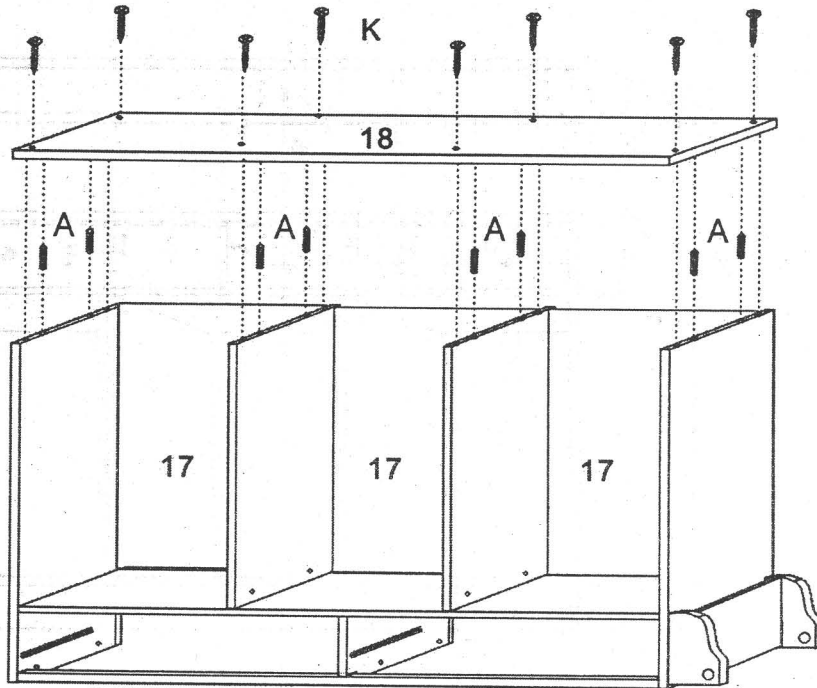

Insert Wooden Dowel(A) and assemble the Bottom Panel(18) to assembled unit by using screw(K) as shown

## STEP 6

Assemble the Castor with Brake(O) at front position and Castor without Brake(P) at Rear Position by using Castor Screw(L).

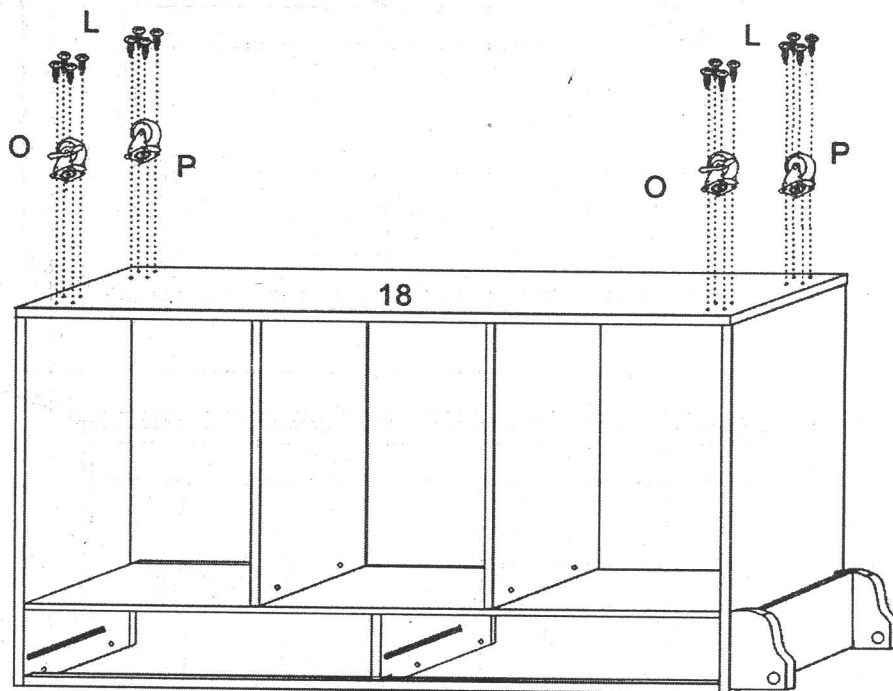

## STEP 7

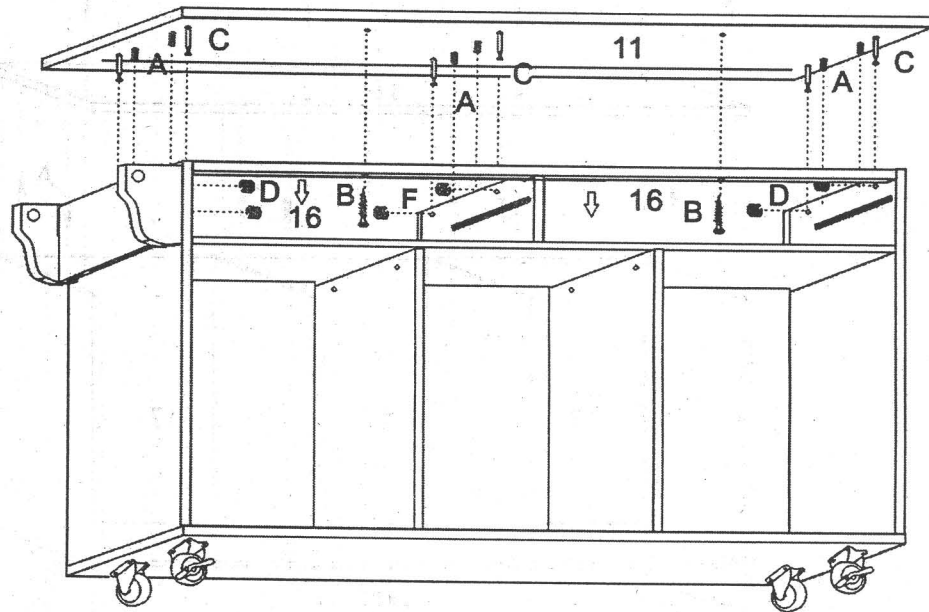

Insert Upper Back Panel(16) to assembled unit as shown.

Install the Long Bolt(C) and Wooden Dowel(A) to Top panel(11) and assemble with assembled unit by using screw(B),Big Camlock(D) and Small Camlock(F) as shown.

## STEP 8

Insert the Shelf Pin(M),Tower Rack Bar(14),Shelf(19) to Assembled Unit as shown.

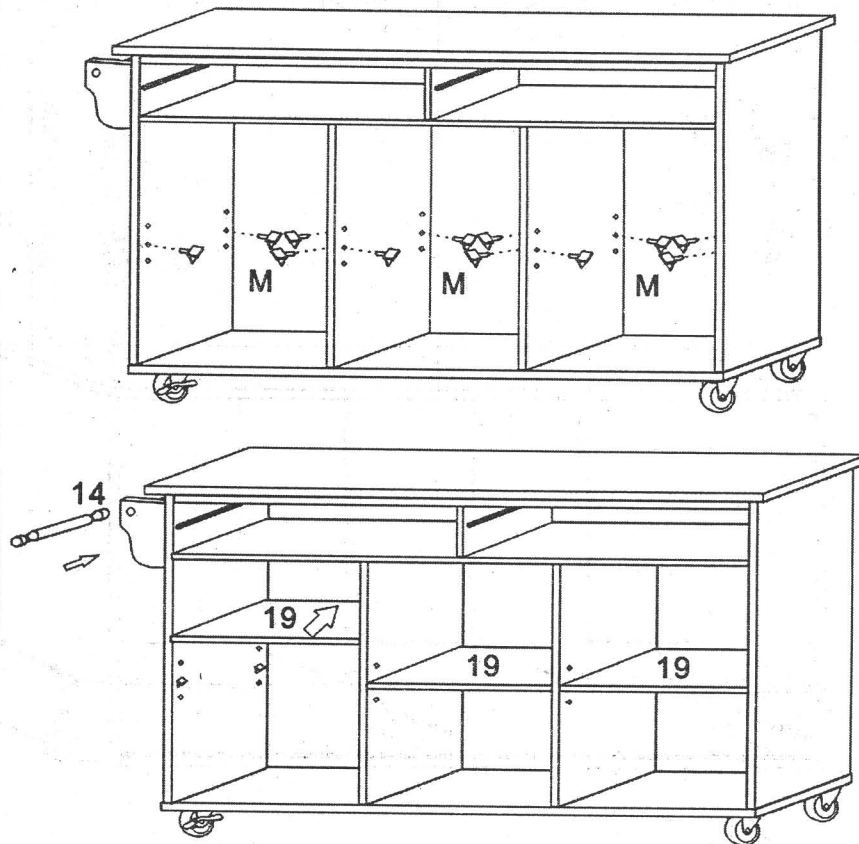

## STEP 9

Assemble the Magnetic Catch(V) to Assembled Unit and Metal Bar(W) to Left Door(20) and Right Door(21) by using screw(S).

Assemble Handle(G) to Left Door(20) and Right Door(21) by using Handle Bolt(H).

Assemble the Left Hinges(N) to Left Door(20) and Right Hinges(X) to Right Door(21) as shown.

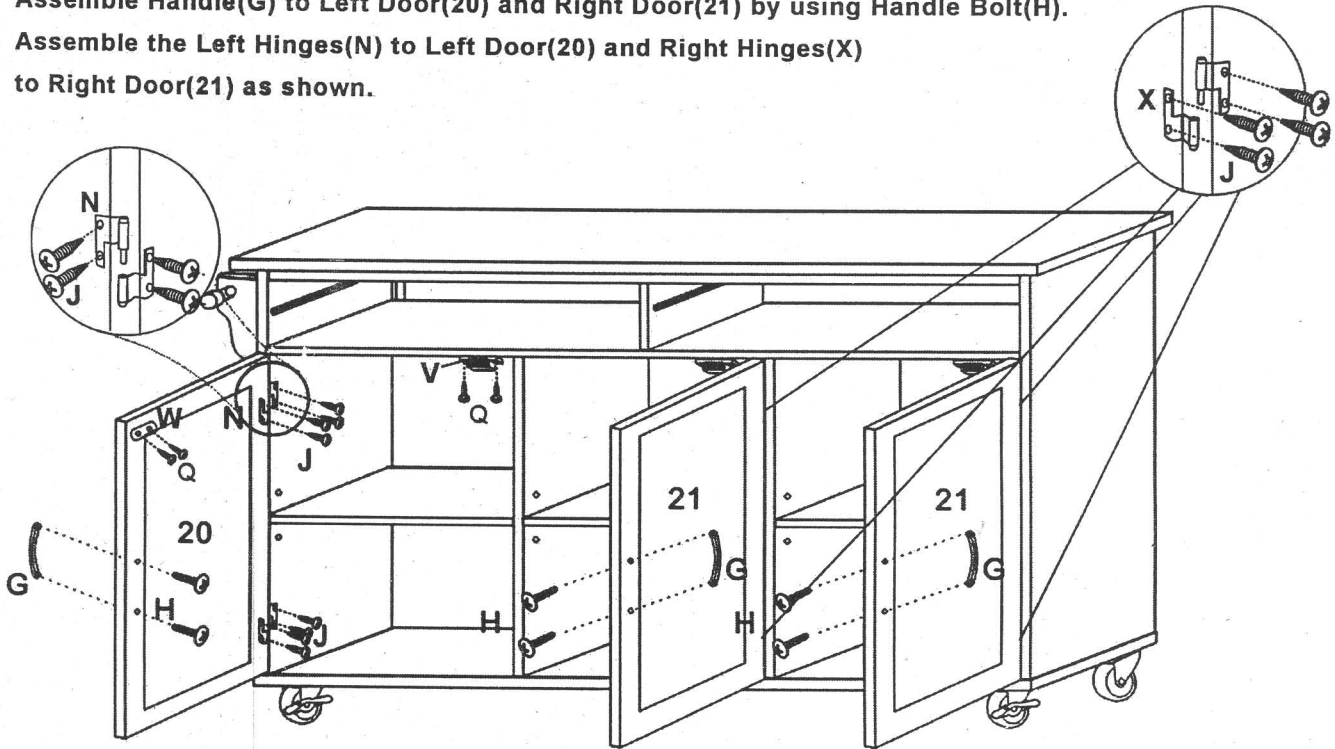

## STEP 10

Insert Door Stopper(I) while inserting both Drawer to the assembled unit.

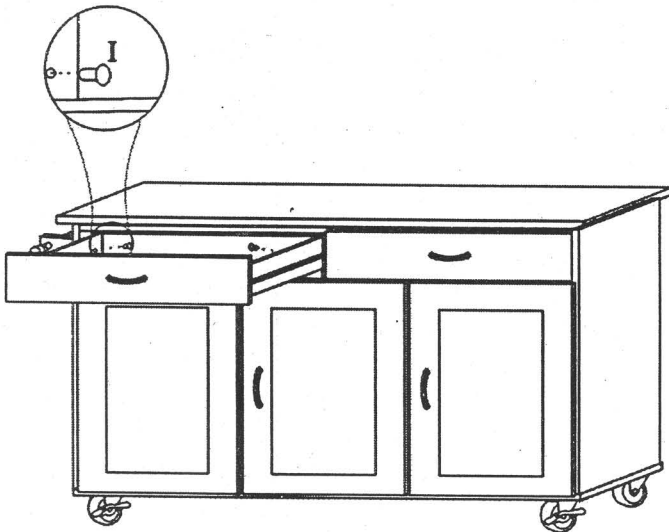

## STEP 11

