

ASSEMBLY INSTRUCTIONS



5 min



2 pers

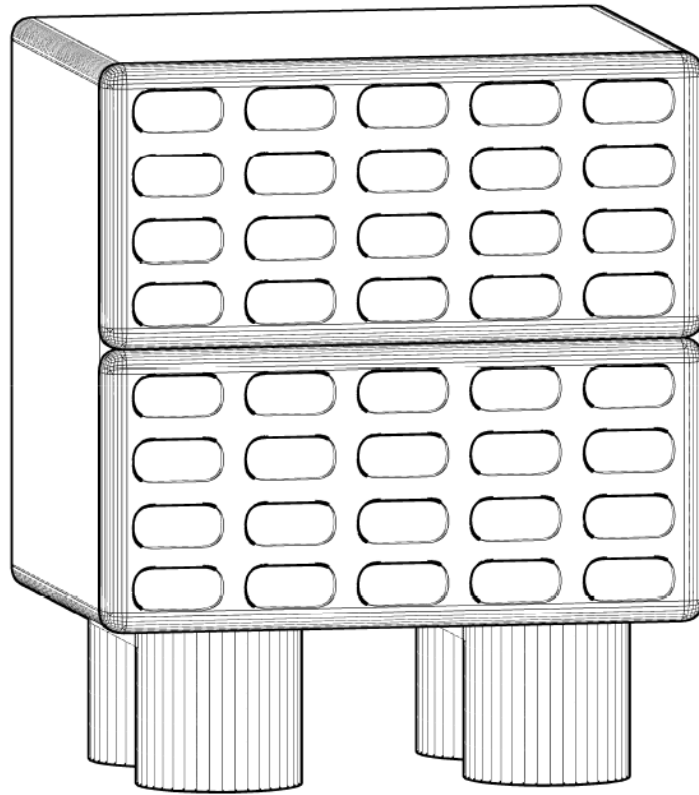

A

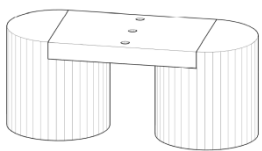

Bx2

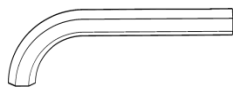

Cx1

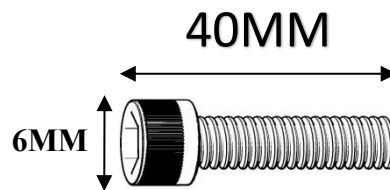

Dx6

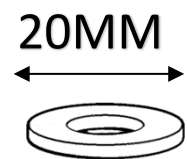

Ex6

1

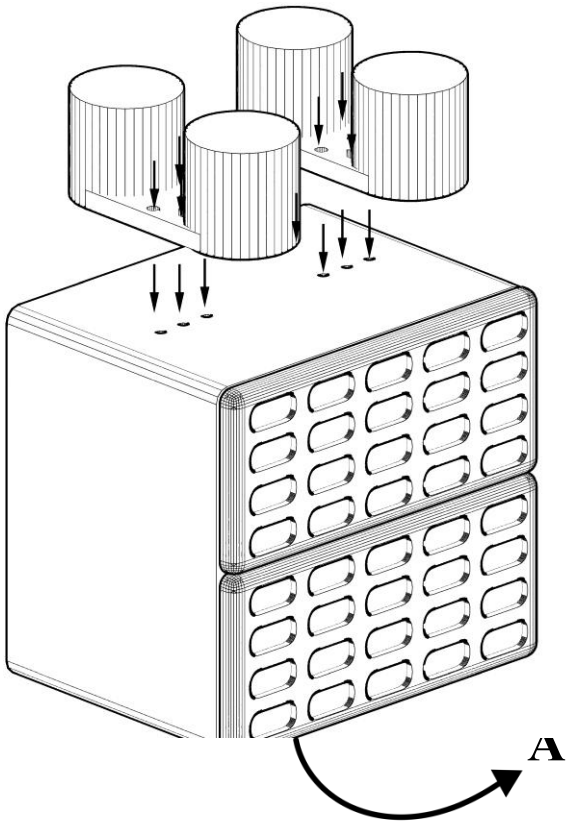

2

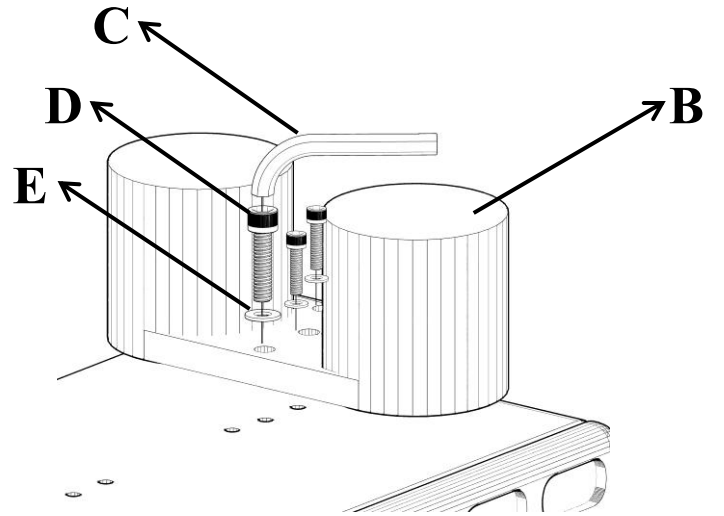

3

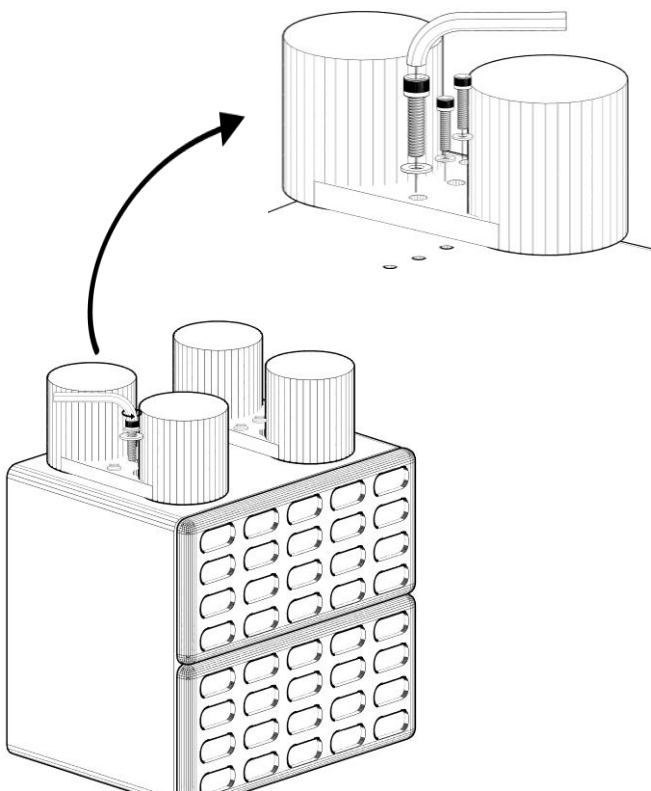

4

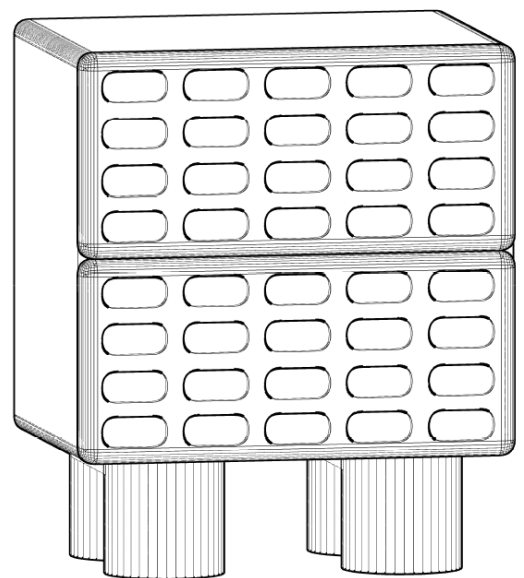

Now product is ready for use