



**INSTRUCTIONS D'ASSEMBLAGE  
ASSEMBLY INSTRUCTIONS**

---

---

**ETAGERE -  
72"H / CERISE EN COIN**

**BOOKCASE -  
72"H / CHERRY CORNER ACCENT ETAGERE**



**POUR DE L'ASSISTANCE OU POUR COMMANDER  
DES PIÈCES CONTACTEZ NOTRE DÉPARTEMENT  
DE SERVICE À LA CLIENTÈLE.**

**FOR ASSISTANCE OR TO ORDER PARTS  
CONTACT OUR CUSTOMER SERVICE DEPARTMENT**

## LISTE DES PIÈCES PARTS LIST

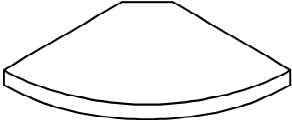
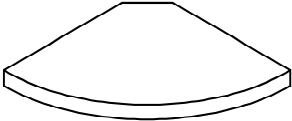
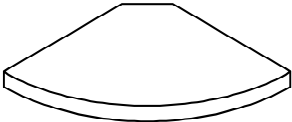
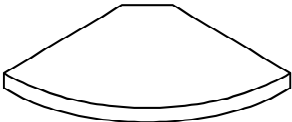
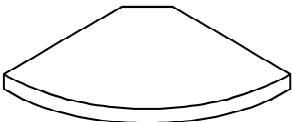
PIÈCE / PART #	IMAGE	DESCRIPTION	QTY / QTÉ
<b>1</b>		<b>TOP SHELF ÉTAGÈRE SUPÉRIEURE</b>	<b>1</b>
<b>2</b>		<b>SHELF PANEL PANNEAU DE TABLETTE</b>	<b>1</b>
<b>3</b>		<b>SHELF PANEL PANNEAU DE TABLETTE</b>	<b>1</b>
<b>4</b>		<b>SHELF PANEL PANNEAU DE TABLETTE</b>	<b>1</b>
<b>5</b>		<b>SHELF PANEL PANNEAU DE TABLETTE</b>	<b>1</b>

## LISTE DES PIÈCES PARTS LIST

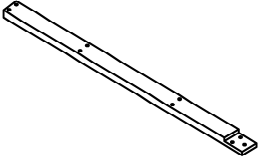
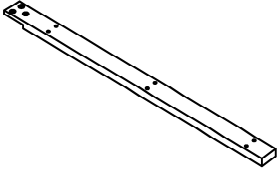
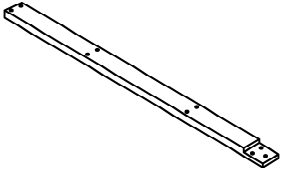
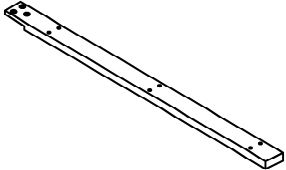
PIÈCE / PART #	IMAGE	DESCRIPTION	QTY / QTÉ
<b>6</b>		<b>BOTTOM SHELF ÉTAGÈRE DU BAS</b>	<b>1</b>
<b>7</b>		<b>FRONT FACING LEFT LEG PATTE AVANT GAUCHE</b>	<b>1</b>
<b>8</b>		<b>FRONT FACING LEFT LEG PATTE AVANT GAUCHE</b>	<b>1</b>
<b>9</b>		<b>FRONT FACING RIGHT LEG PATTE AVANT DROITE</b>	<b>1</b>
<b>10</b>		<b>FRONT FACING RIGHT LEG PATTE AVANT DROITE</b>	<b>1</b>

**LISTE DES PIÈCES**  
**PARTS LIST**

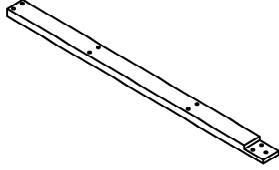
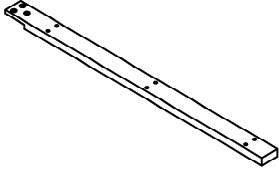
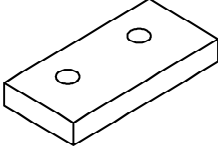
PIÈCE / PART #	IMAGE	DESCRIPTION	QTY / QTÉ
11		<p>BACK LEG SUPPORT BARRE DE SOUTIEN ARRIERE</p>	1
12		<p>BACK LEG SUPPORT BARRE DE SOUTIEN ARRIERE</p>	1
13		<p>SUPPORT LEG PATTE DE SOUTIEN</p>	1

**LISTE DES PIÈCES DE MONTAGE**  
**HARDWARE LIST**

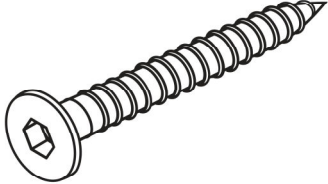
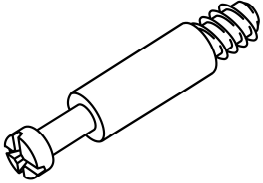
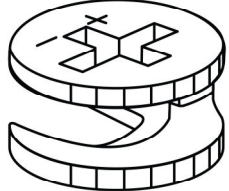
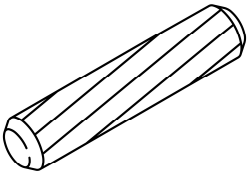
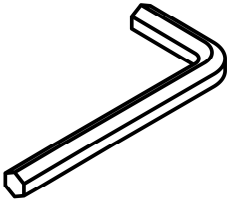
PIÈCE / PART #	IMAGE	DESCRIPTION	QTY / QTÉ
<b>A</b>		ASSEMBLING SCREW - Ø1/4" X 2" VIS D'ASSEMBLAGE - Ø1/4" X 2"	<b>18</b>
<b>B</b>		CAM LOCK SCREW VIS CAM LOCK	<b>2</b>
<b>C</b>		CAM LOCK CONNECTOR ÉCROU CAM LOCK	<b>2</b>
<b>D</b>		WOOD DOWEL GOUJON DE BOIS	<b>18</b>
<b>E</b>		HEX KEY CLÉ HEXAGONALE	<b>2</b>

## LISTE DES PIÈCES DE MONTAGE HARDWARE LIST

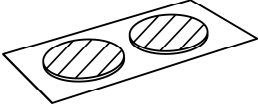
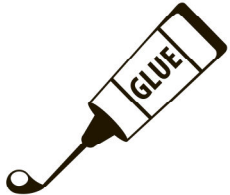
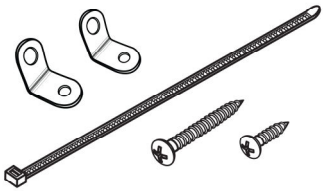
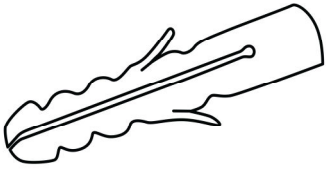
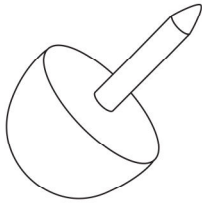
PIÈCE / PART #	IMAGE	DESCRIPTION	QTY / QTÉ
<b>F</b>		FINISHING STICKER COLLANT DE FINITION	36
<b>G</b>		GLUE COLLE	1
<b>H</b>		WALL MOUNT SET ENSEMBLE DE MONTAGE MURAL	1
<b>I</b>		ANCHOR ANCRE	1
<b>J</b>		FLOOR PROTECTOR PROTECTEUR DE PLANCHER	5

**LISTE DES PIÈCES DE MONTAGE**  
**HARDWARE LIST**

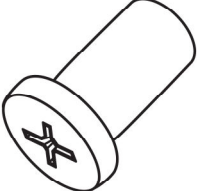
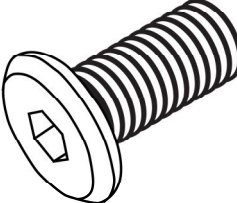
PIÈCE / PART #	IMAGE	DESCRIPTION	QTY / QTÉ
<b>K</b>		<b>BARREL NUT</b> <b>ÉCROU DE CANON</b>	<b>9</b>
<b>L</b>		<b>ASSEMBLING BOLT -</b> <b>Ø1/4" X 1/2"</b> <b>BOULON D'ASSEMBLAGE -</b> <b>Ø1/4" X 1/2"</b>	<b>9</b>



OUTIL DE VÉRIFICATION DE DIMENSIONS DES PIÈCES  
HARDWARE DIMENSIONS VERIFICATION TOOL



ÉTAPE / STEP 1

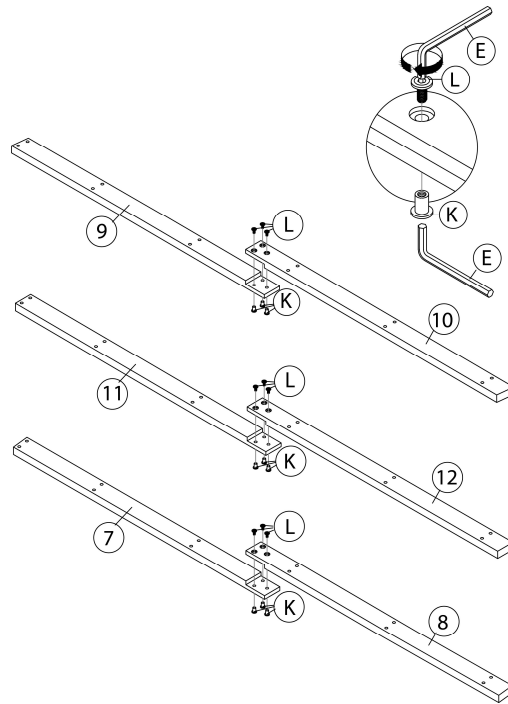

ÉTAPE / STEP 2

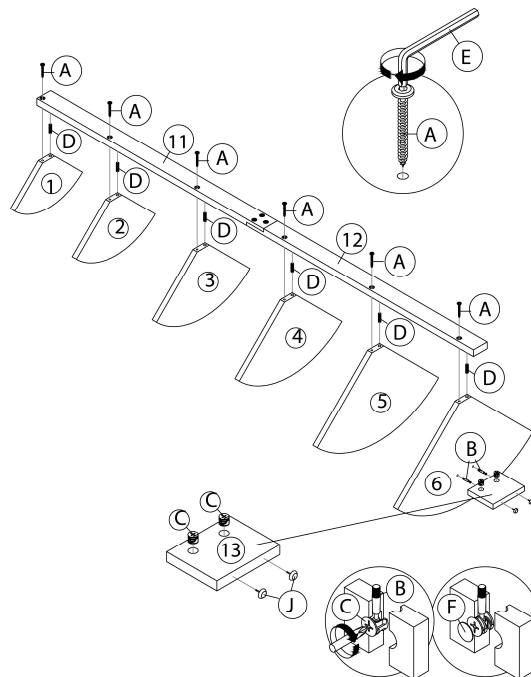

**ÉTAPE / STEP 3**

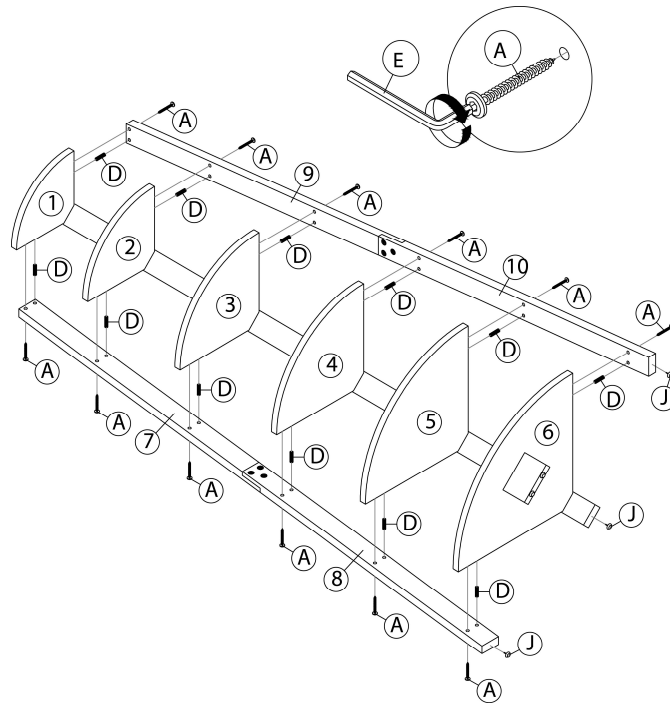

**ÉTAPE / STEP 4**

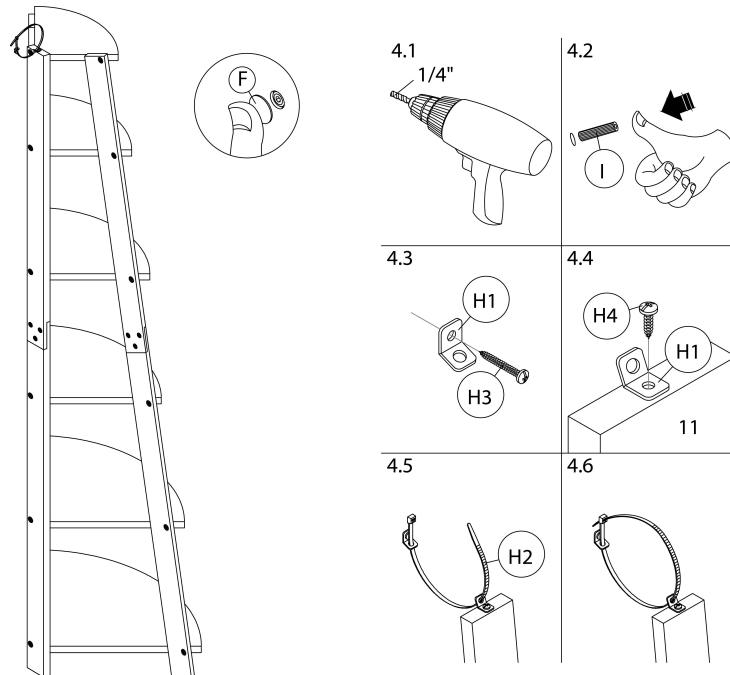

ÉTAPE / STEP 5

