

Weight Limitation

100 LBS



Installation:

45 minutes.



Two Person

Thank You For Choosing Our Furniture

- ▀ If you have any questions or concerns, don't hesitate to reach out to us. ▀

NOTE:

This brochure contains IMPORTANT safety info. Please read and keep it for future reference.

MAINTENANCE AND WARNINGS



Before You Start

Please follow the steps below:

- ⚠ Check the packaging for any damage, deformation, or water stains. If there is significant damage, please contact us promptly.
- ⚠ Unpack the box and compare the contents with the parts list and hardware list to ensure all components and accessories are present and complete.
- ⚠ Please read the installation instructions carefully to understand the installation steps and precautions to ensure proper installation.
- ⚠ Clean the installation area in advance and ensure the ground is level and there is enough space to avoid damaging the furniture or making installation difficult.
- ⚠ Lay a protective mat on the ground to prevent scratching the floor during installation.

After-Sales Service

- If you encounter any issues or need technical support during use, please contact our after-sales team. We offer long-term maintenance and warranty services.



Precautions

- ⚠ This product is for indoor use only. Do not expose it to outdoor elements or high-humidity environments.
- ⚠ Keep the product away from high heat or open flames to prevent fire hazards.
- ⚠ Do not allow children to climb on the product, as this may cause tipping and result in personal injury.



Safety Warnings

- ⚠ If you notice any loose or damaged parts, stop using the product immediately and contact customer service.
- ⚠ Do not attempt to disassemble or replace any components yourself, as this may affect the stability and safety of the product.

Daily Maintenance

- Regularly clean the surface with a soft cloth to prevent dust accumulation.
- Do not use cleaning agents containing acids, alkalis, or corrosive substances, as they may damage the surface. It is recommended to use neutral cleaning agents or specialized furniture cleaners.
- Avoid exposing furniture to humid environments for extended periods. Use a dehumidifier or desiccant during humid weather.
- Avoid direct contact of furniture with water. If water is accidentally spilled, wipe it dry immediately.
- Avoid placing excessively heavy objects on the furniture: ensure the weight is within a reasonable load-bearing range.
- Avoid using sharp or rough items on the furniture surface to prevent scratches. Handle items gently when moving them.

Explosive view

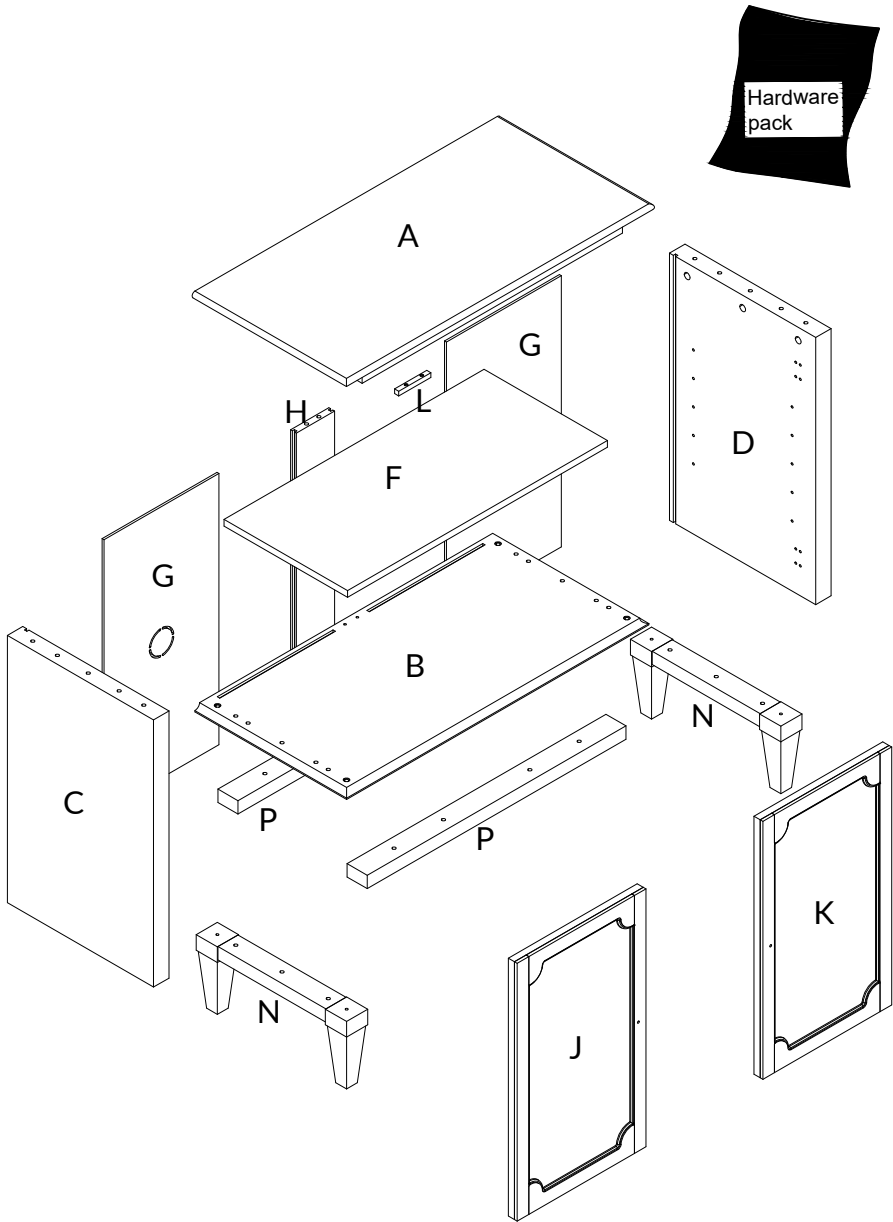

Parts list

A x1 Top panel

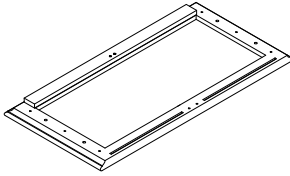

B x1 Bottom panel

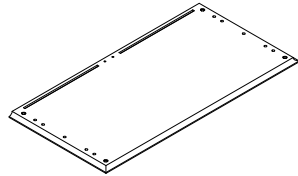

C x1 Side panel

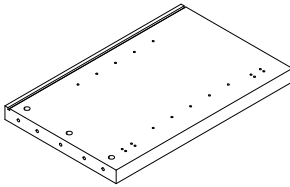

D x1 Side panel

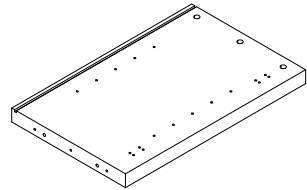

F x1 Shelf board

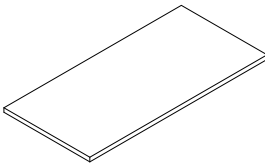

G x2 Back panel

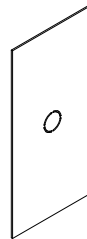

H x1 Support board



J x1 Door panel

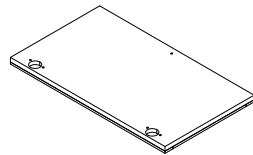

Parts list

Kx1 Door panel



N x2 Legs

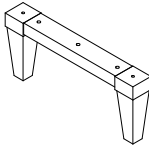



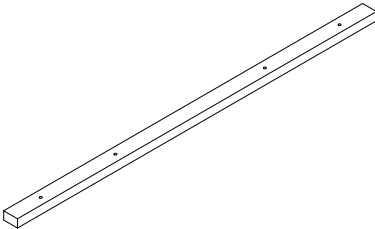



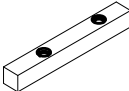

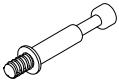

P x2 connect rod

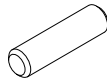



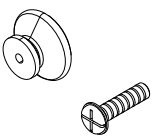

L x1 Stop block

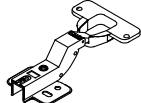

Hardware List

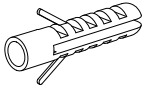
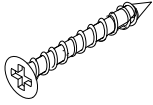
| | | |
|--|--|---|
| <p>①x10+1 Bolt</p>  <p>L15*12mm</p> | <p>②x10+1 Cam bolt</p>  <p>L15*12mm</p> | <p>③x12+2 Wooden dowel</p>  <p>L8*30mm</p> |
| <p>④x2 Bolt</p>  <p>L6x25mm</p> | <p>⑤x4 Screw</p>  <p>L6x35mm</p> | <p>⑥x12+1 Screw</p>  <p>L3.5x14mm</p> |
| <p>⑦x2 handle</p>  <p>L4x30mm</p> | <p>⑧ x8 retaining clip</p>  <p></p> | <p>⑨x10+1 Sticker</p>  <p></p> |
| <p>⑩x4 Screw</p>  <p>L7x40mm</p> | <p>⑪x4 Shelf support</p>  <p></p> | <p>⑫x4 Hinge</p>  <p></p> |

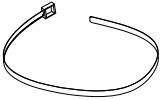
Hardware List

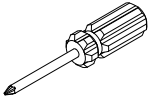
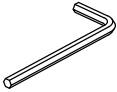

| | | |
|--|---|---|
| <p>⑬ x6 Screw</p>  <p>L7x70mm</p> | <p>⑭ x4 Expansion pipe</p>  <p>L30mm</p> | <p>⑮ x4 Screw</p>  <p>L4*30mm</p> |
| <p>⑯ x4 Plastic buckle</p>  | <p>⑰ x2 Plastic belt</p>  | <p>⑱ x24+3 Screw</p>  <p>L4x16mm</p> |
| <p>⑲ x1 Screwdriver</p>  | <p>⑳ x1 Allen key</p>  | |

Step 1

Prepare for part A

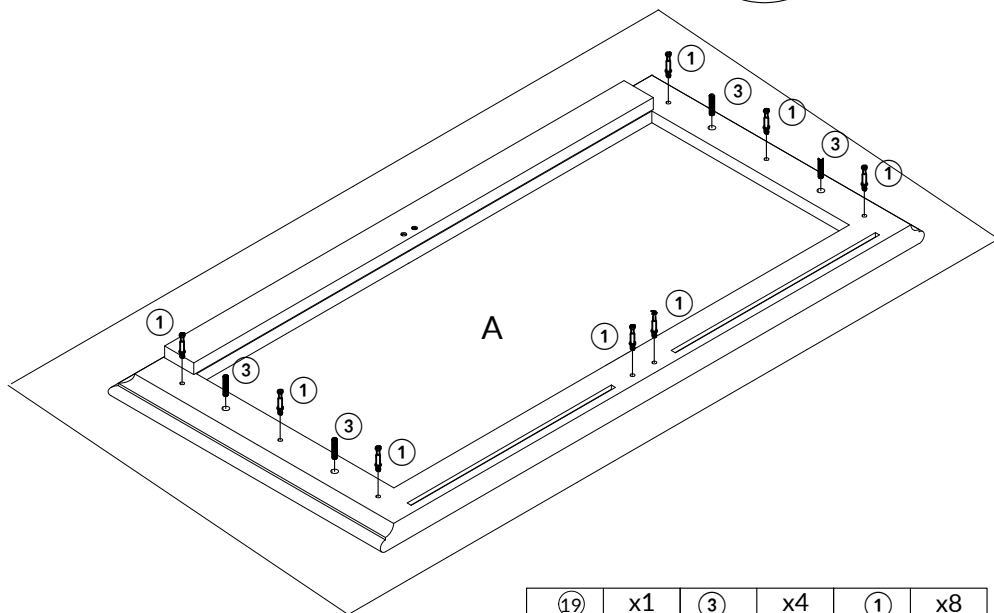
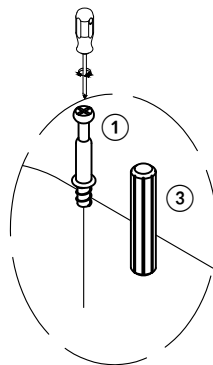
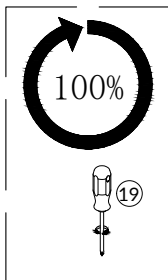
1. Tighten the bolt ① into the corresponding hole of A with screwdriver ⑱
2. Align the holes in part A, insert wooden dowel ③ by hand

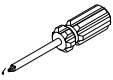

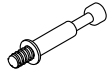

| ⑱ | x1 | ③ | x4 | ① | x8 |
|---|----|---|----|--|----|
|  | |  | |  | |
| | | D8x30mm | | M6x35mm | |

Step 2

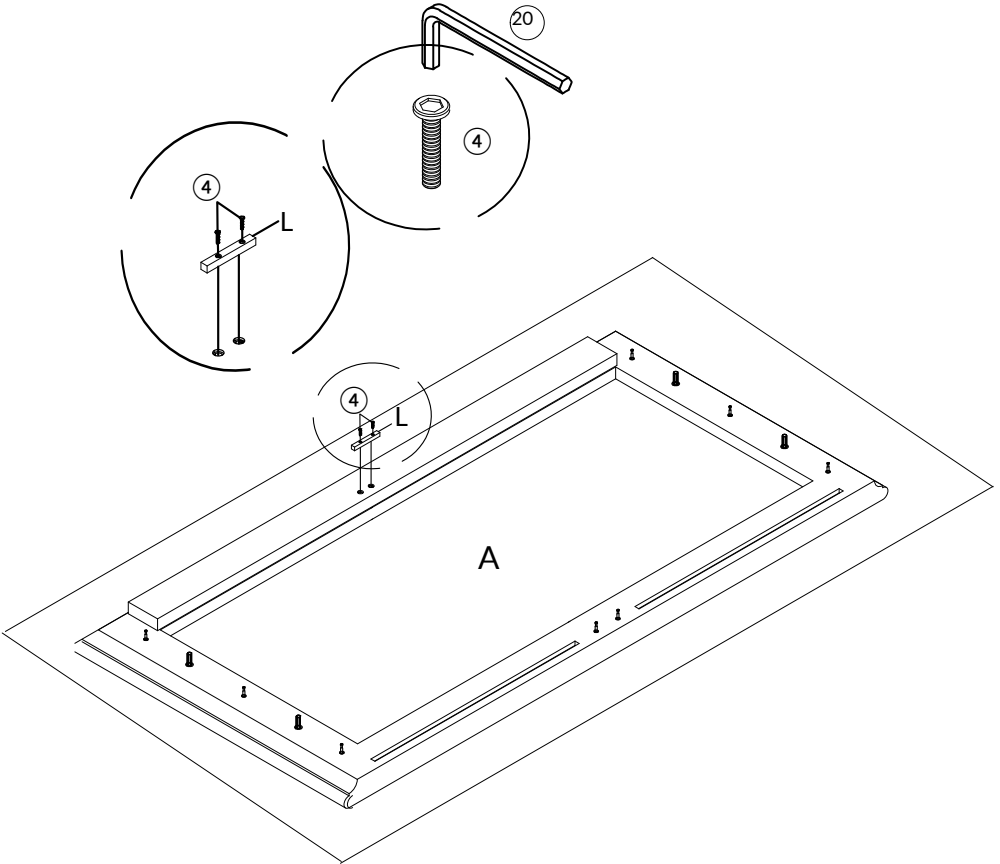
Use bolt ④ to attach part L with allen key ⑳ as picture shown





| ⑳ | x1 | ④ | x2 |
|---|----|---|----|
|  | |  | |
| | | M6x25mm | |

Step 3

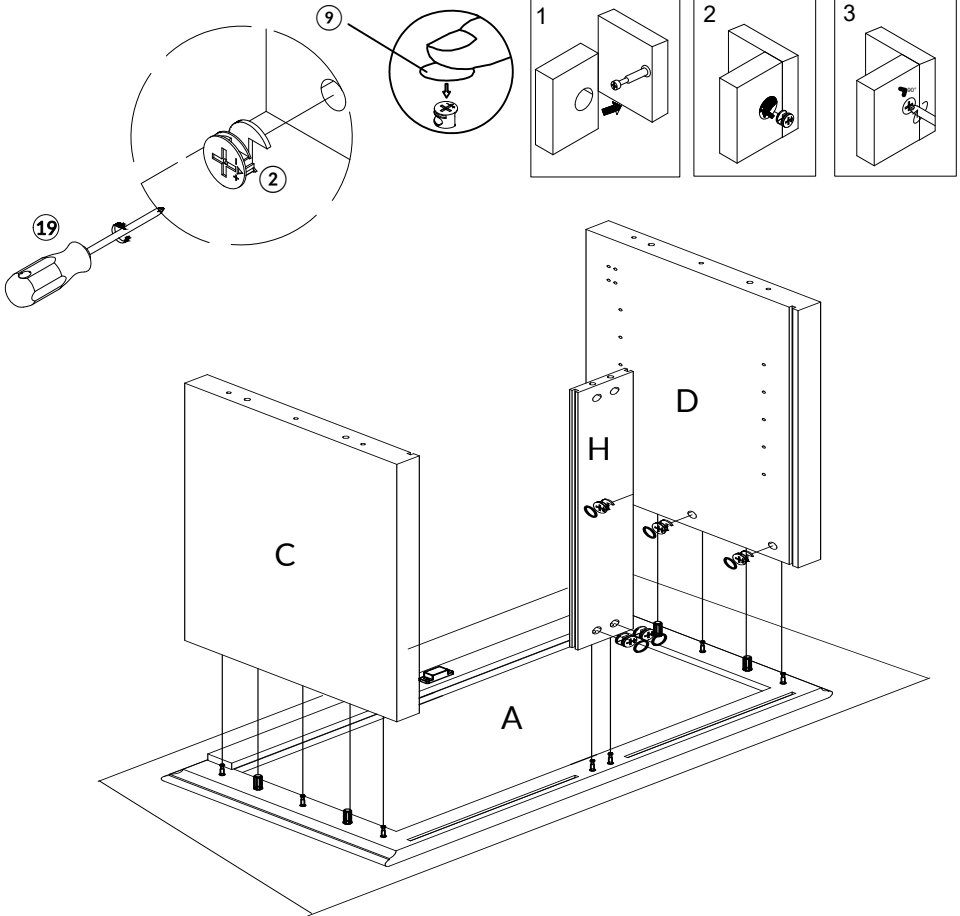
1. Connect part C&H & D with part A, insert cam bolt ② into the corresponding holes of part C&H& D. then tighten the cam bolt ② with screwdriver ⑱
- 2.. Cover the cam lock ② with sticker ⑨

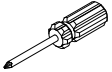

| ② | x6 | ⑨ | x6 | ⑱ | x1 |
|---|----|---|----|--|----|
|  | |  | |  | |
| D15x12mm | | | | | |

Step 4

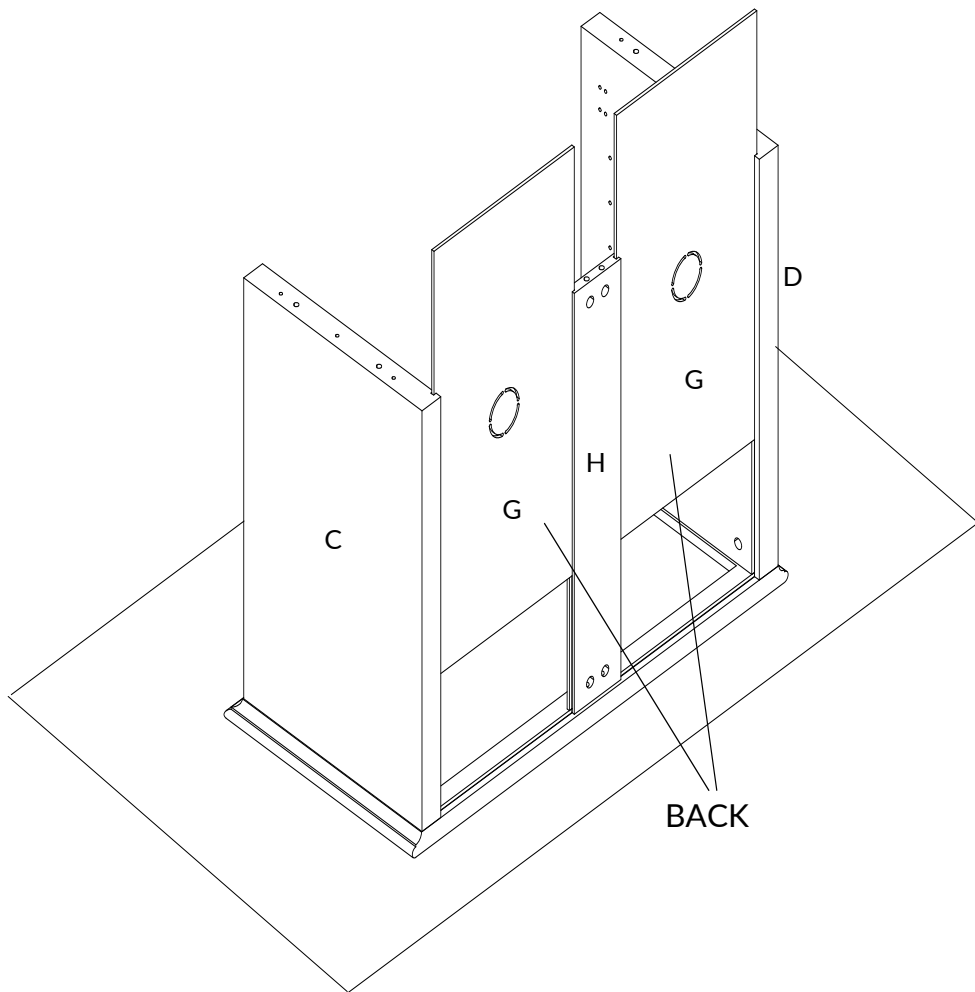

1. Slide in part G into the groove in part C,H and H,D make sure they are also in groove
2. Please make sure that the panels which stick "BACK" are toward wall

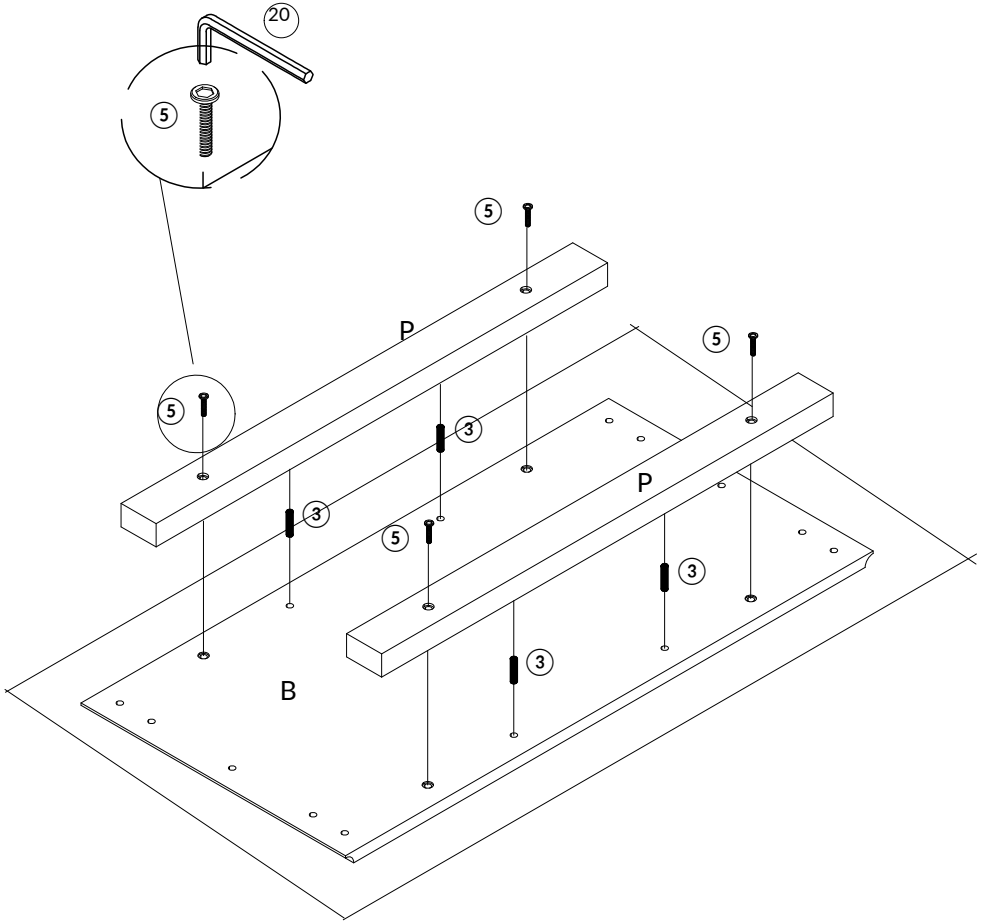

Step 5

1. Align the holes in part B, insert wooden dowel ③ by hand
2. Use bolt ⑤ to attach part P to part B with the Allen key ⑳



| ⑳ | x1 | ⑤ | x4 | ③ | x4 |
|---|----|---|----|---|----|
|  | |  | |  | |
| | | D6x35mm | | D8x30mm | |

Step 6

1. Use (10) to attach part B to part N with Allen key (20)
- 2.. Tighten the bolt (1) into the corresponding hole of B with screwdriver (19)

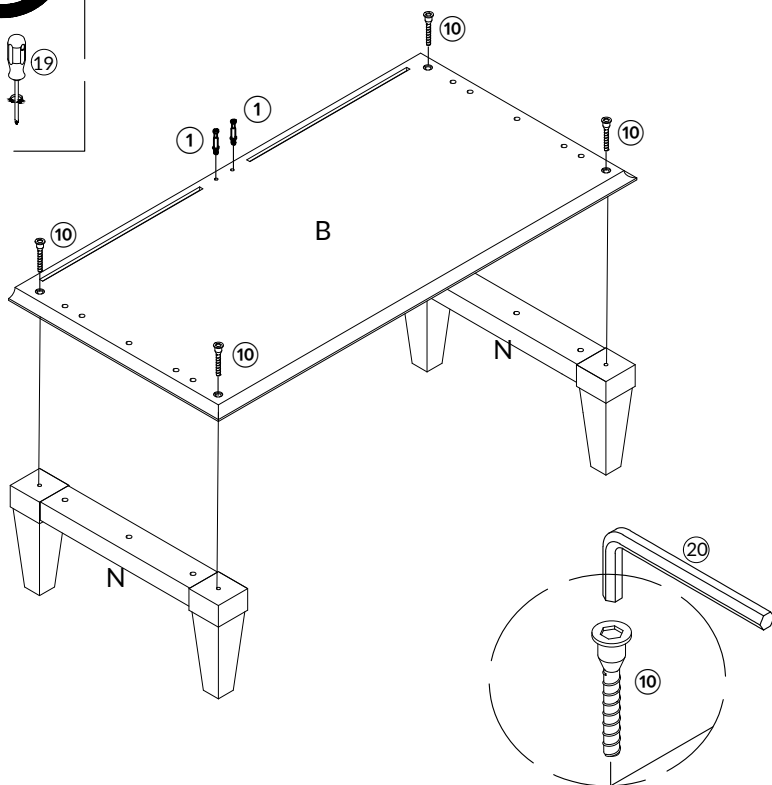
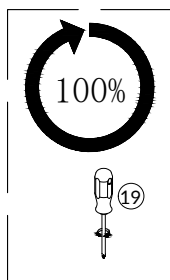

| (1) | x2 | (19) | x1 | (20) | x1 | (10) | x4 |
|---------|----|------|----|------|----|---------|----|
| | | | | | | | |
| D6x35mm | | | | | | D7x40mm | |

Step 7

Connect the prepared parts together

1. Align the holes in part C&D, insert wooden dowel (3) by hand
2. Screw the bolt (13) tight with Allen key (20)
3. Insert cam bolt (2) into the corresponding holes of part G. then tighten the cam bolt (2) with screwdriver (19)
- 4.. Cover the cam lock (2) with sticker (9)

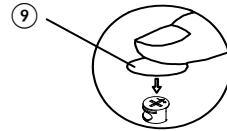
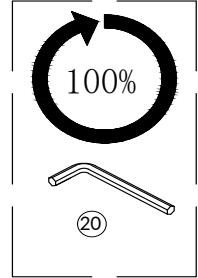
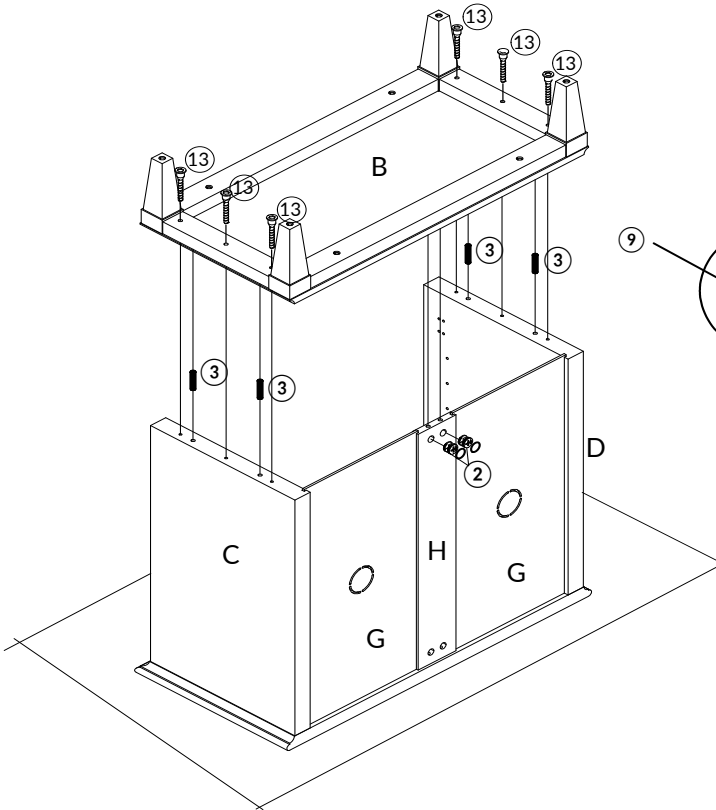



| | | | | | | | | | | | |
|----------|----|-----|----|------|----|---------|----|---------|----|------|----|
| (2) | x2 | (9) | x2 | (19) | x1 | (3) | x4 | (13) | x6 | (20) | x1 |
| | | | | | | | | | | | |
| D15x12mm | | | | | | D8x30mm | | D7x70mm | | | |

Step 8

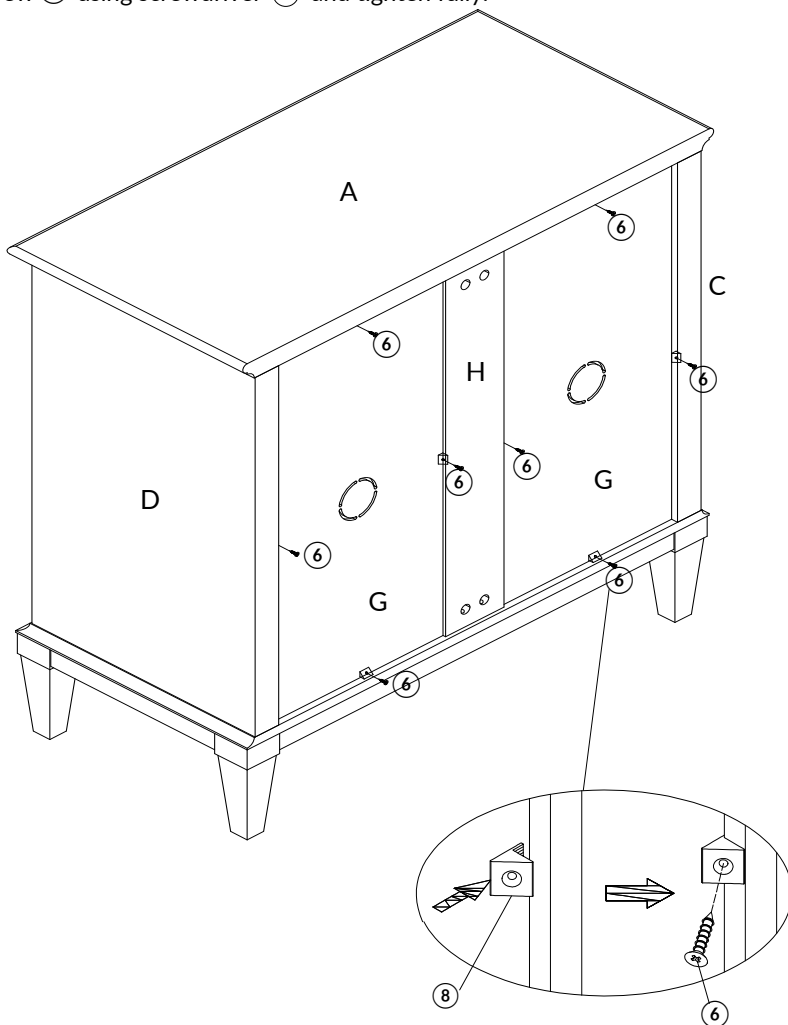
1. Insert hardware ⑧ into part G as show
2. Screw in screw ⑥ using screwdriver ⑲ and tighten fully.



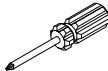

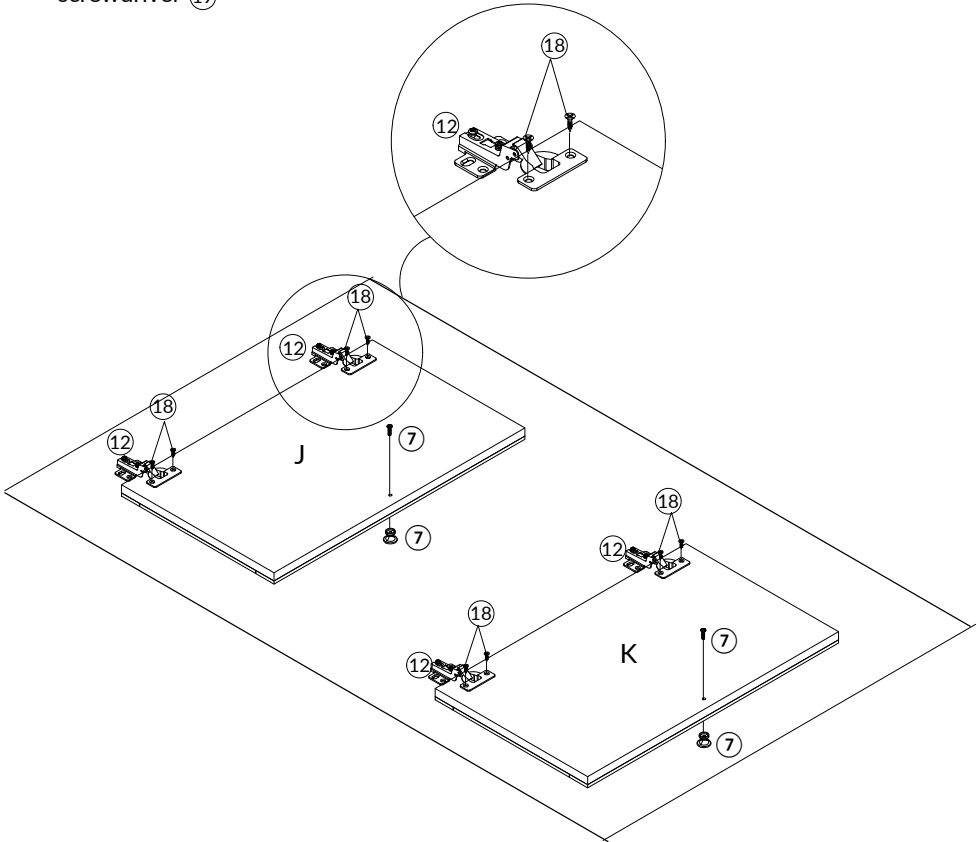

| ⑥ | x8 | ⑧ | x8 | ⑲ | x1 |
|---|----|---|----|--|----|
|  | |  | |  | |
| D3.5x14mm | | | | | |

Step 9

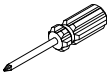
1. Use screw ⑱ to attach the hinges ⑫ to door panel (J&K), tighten screws ⑱ with screwdriver ⑲
2. Use screw ⑦ to attach the handle ⑦ to door panel (J&K), tighten screws ⑦ with screwdriver ⑲



| ⑲ | x1 | ⑦ | x2 | ⑱ | x8 | ⑫ | x4 |
|---|----|---|----|---|----|---|----|
|  | |  | |  | |  | |
| | | D4x30mm | | D4x16mm | | Large Bend | |

Step 10

Insert shelf support ⑪ into the holes attach shelf board F to ⑪

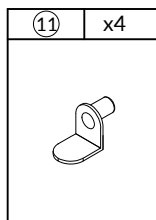
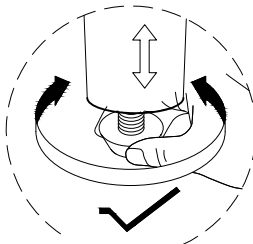
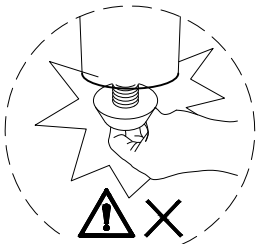
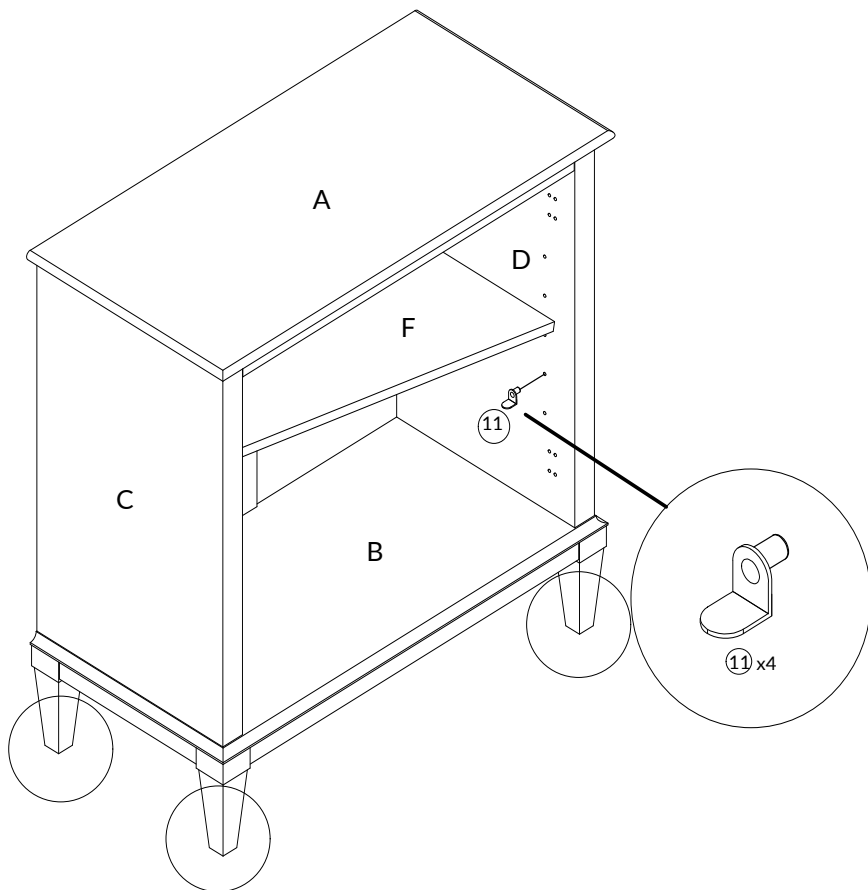

Step 11

1. Use screw ⑱ to attach door panel J to part C, tighten screws ⑱ with screwdriver ⑲
2. Use screw ⑱ to attach door panel K to part D, tighten screws ⑱ with screwdriver ⑲

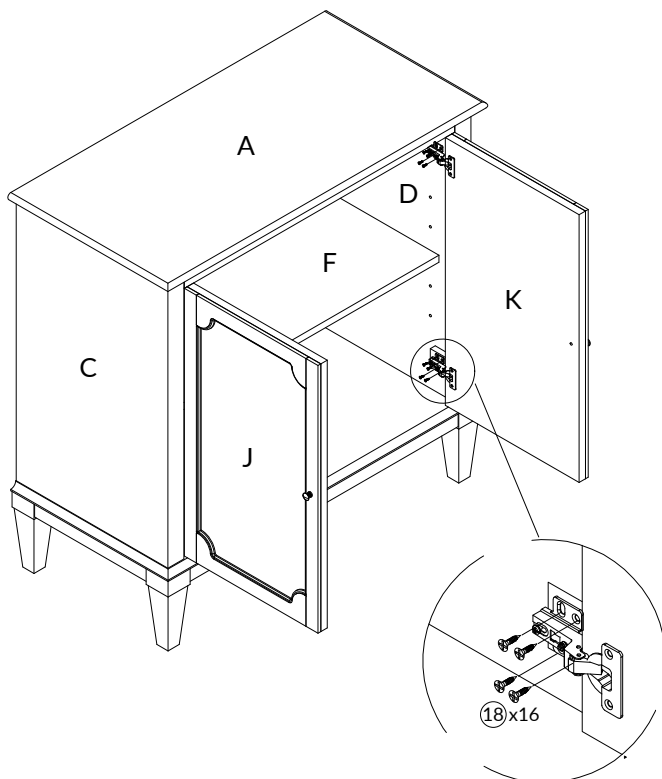

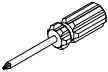
| ⑱ | x16 | ⑲ | x1 |
|---|-----|---|----|
|  | |  | |
| D4x16mm | | | |

Door Hinge Adjustment Instructions

Concealed hinges are three-way adjustable.

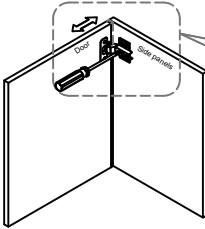

Horizontal by screw adjustment!

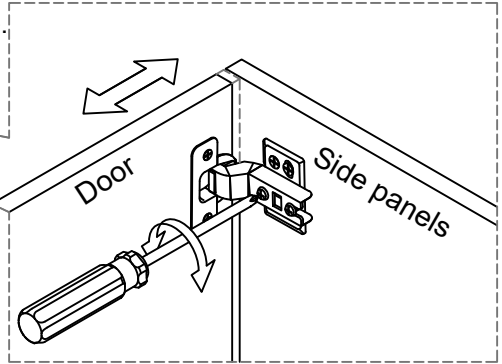

Concealed hinges are three-way adjustable.

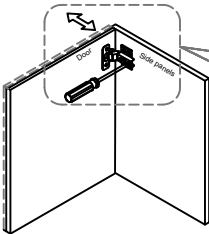

In-and-out by loosening the hinge arm mounting screw or via cam adjustment!

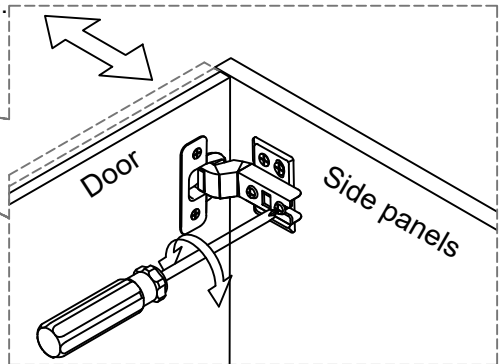

Concealed hinges are three-way adjustable.

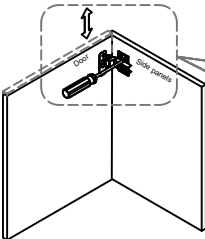

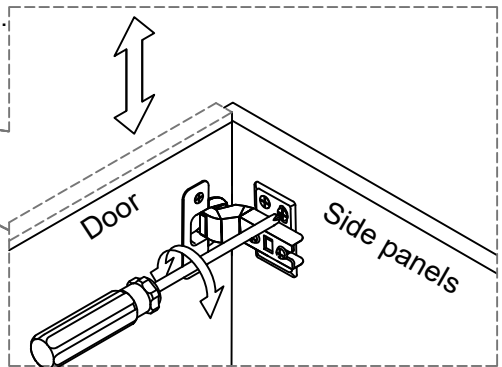

Vertical via slots in the mounting plate or via cam adjustment!

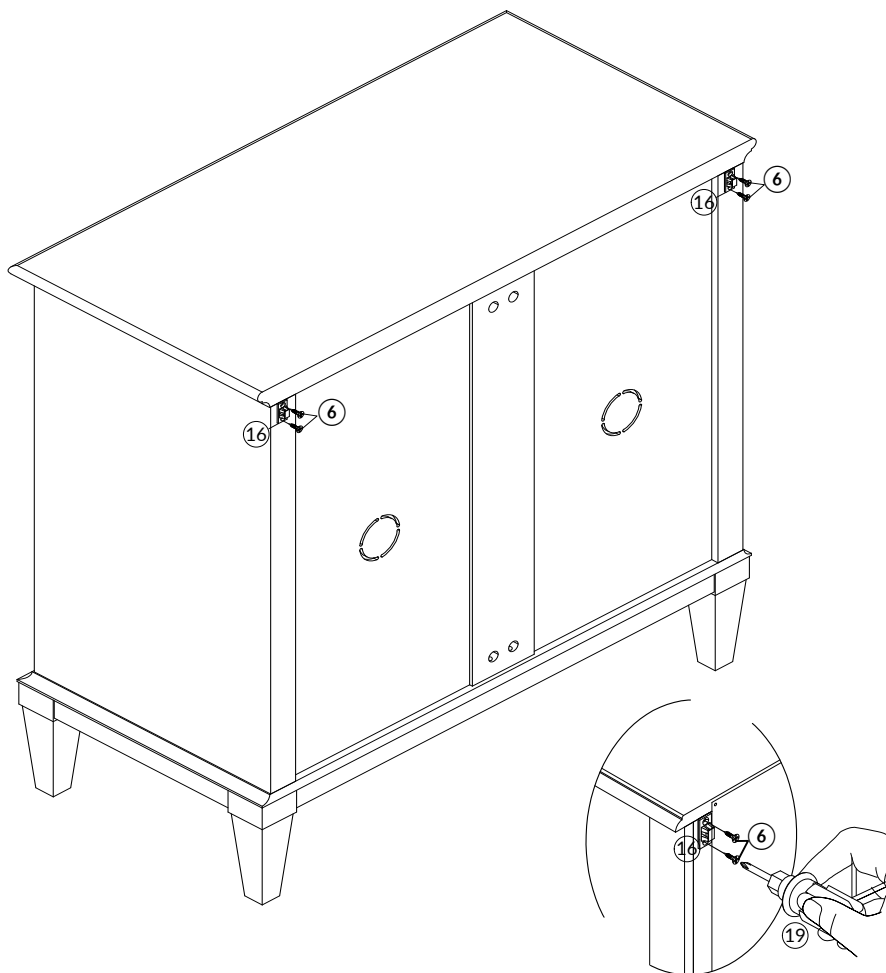

Step 12

Use screws ⑥ to attach part ⑩ with screwdriver ⑲ as picture shown

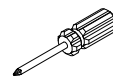

| ⑥ | x4 | ⑩ | x2 | ⑲ | x1 |
|---|----|---|----|--|----|
|  | |  | |  | |
| D3.5x14mm | | | | | |

Step 13

1. Install the anti-collapse device.
2. Mark the position on the wall, that corresponds to the location of part ⑩ on the Side panel C&D ; Drill and insert ⑭ by hammer.
3. Assemble the part ⑩ to the wall. Align the hole in the part ⑩ with ⑭, use ⑮ to attach it and tighten by screwdriver ⑰

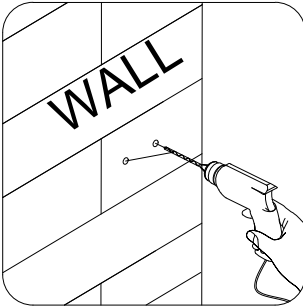
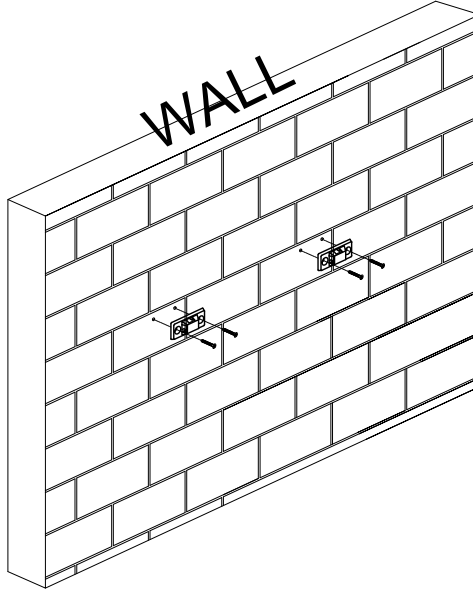

1. Drill a hole in the wall with an electric drill.

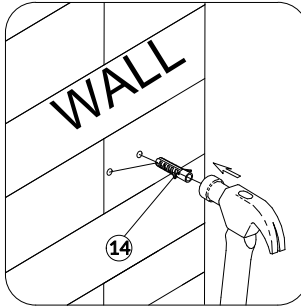

2. Tap the plastic wall anchor into the hole with a hammer.

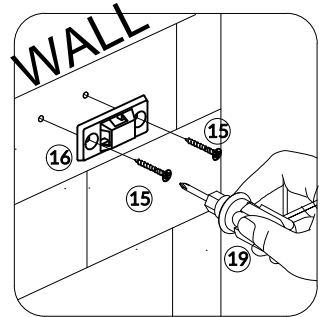

3. Secure the Anti-tip device to the wall with screws

| | | | |
|------|-------------|------|------|
| ⑩ x2 | ⑮ x4 | ⑭ x4 | ⑰ x1 |
| | D4x30mm | | |

Step 14

WARNING

Children have died from furniture tipover.

To reduce the risk of furniture tipover:

- ALWAYS install Anti-tip device provided.
- For use with televisions weighing 35 lb or less. Use with heavier televisions may result in instability causing tip-over resulting in death or serious injury.
- NEVER allow children to stand, climb or hang on drawers, doors, or shelves.
- NEVER open more than one drawer at a time.
- Place heaviest items in the lowest drawers.



Let the part **17** pass through the both parts **16** and pull tightly

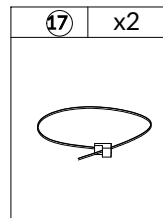
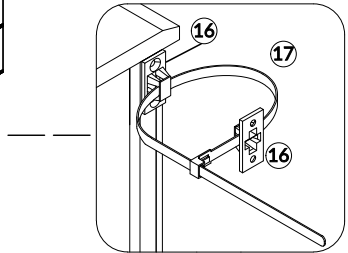
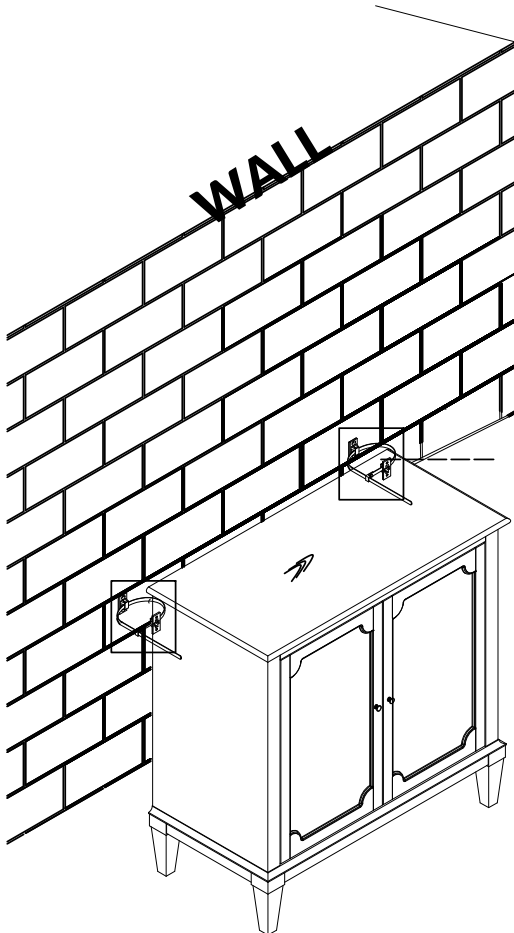

WARRANTY

- We strive to offer quality products, and we also try our best to satisfy every customer who orders from us with products or services as needed.
- Replacement parts can be purchased from our company if available.
- For returns, please check the return policy with the retailer or marketplace where you purchased the item.

We appreciate your purchase.
Brighten your life with our furniture!