











# ASSEMBLY INSTRUCTIONS

ITEM NO : T400

1/1

NO.	PART DESC	SKETCH	Q'TY
A	Table Top		1pc
B	Connector Panel		4pcs
C	Middle Shelf		1pc
D	Leg		4pcs

NO.	HARDWARE DESC	SKETCH	Q'TY
1	Lock Washer (Ø5/16")		8pcs
2	Flat Washer (Ø5/16")		8pcs
3	Long Bolt (Ø5/16" x65mm)		8pcs
4	Short Bolt (Ø5/16" x30mm)		4pcs
5	Short Bolt (Ø1/4" x25mm)		8pcs
6	Allen key (4mm)		1pc

STEP 1: Fully Tighten the bolt .

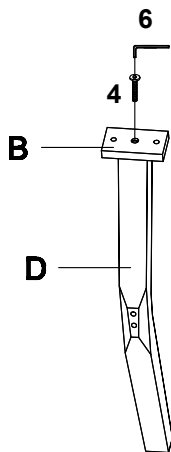

STEP 2: Install 3 of the table legs (D) first. By using Allen Key (6) with hardware 5. Then install the table shelf (C). By using Allen Key (6) with hardware 1, 2, and 3.

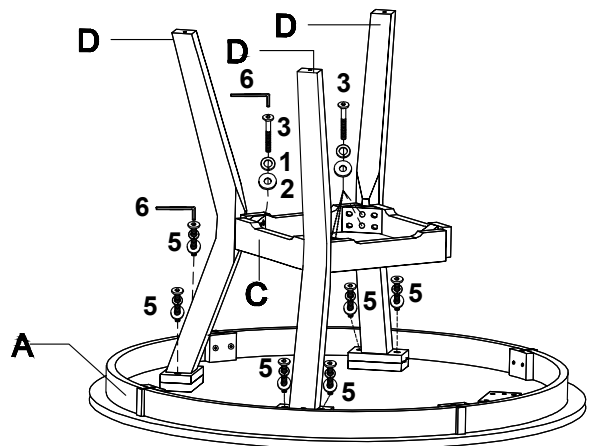

Don't tighten the bolts until last step

STEP 3: Install the last table legs (D). By using Allen Key (6) with hardware 1, 2, 3 and 5. Then tighten all bolts.

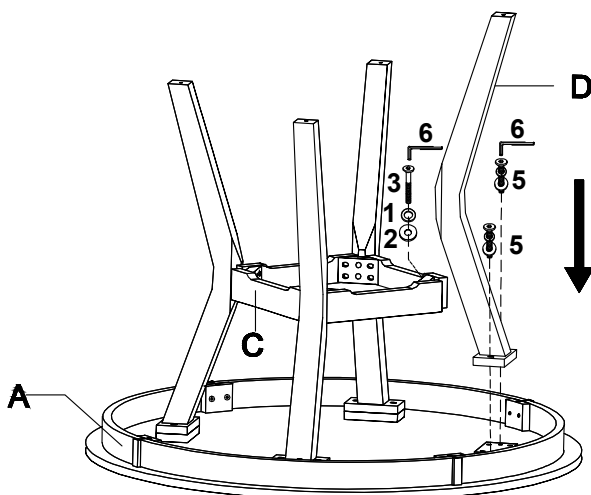

COMPLETED

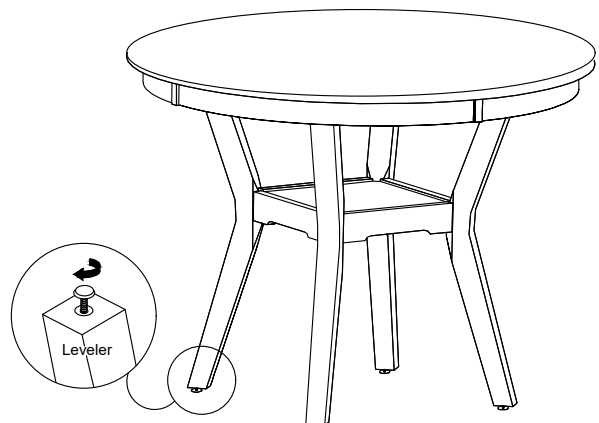

Do not tighten screws until completely assembled.