

ASSEMBLY INSTRUCTION

WF323256/WF323266

TIPS

1. Please read the instructions fully before assembly. These instructions include important information which could ensure correct assembly. We have been working on providing high quality products for you. However, in the rare instance that your product is defective, missing parts or there are some issues, please don't hesitate to contact our customer service to submit parts requirements, assembly suggestion, or warranty claims, and we will give the best solution as soon as possible. If necessary, we need you to provide some more clear pictures of the issue.

2. Insert the screws in holes and tighten the screws, but not too tight, 70%~80% is ok, finally tighten all the screws. If some issues happened that some screws can not target to the hole or some parts are difficult to install, please adjust the tightness of the screws.

3. 2 people are recommended to finish.

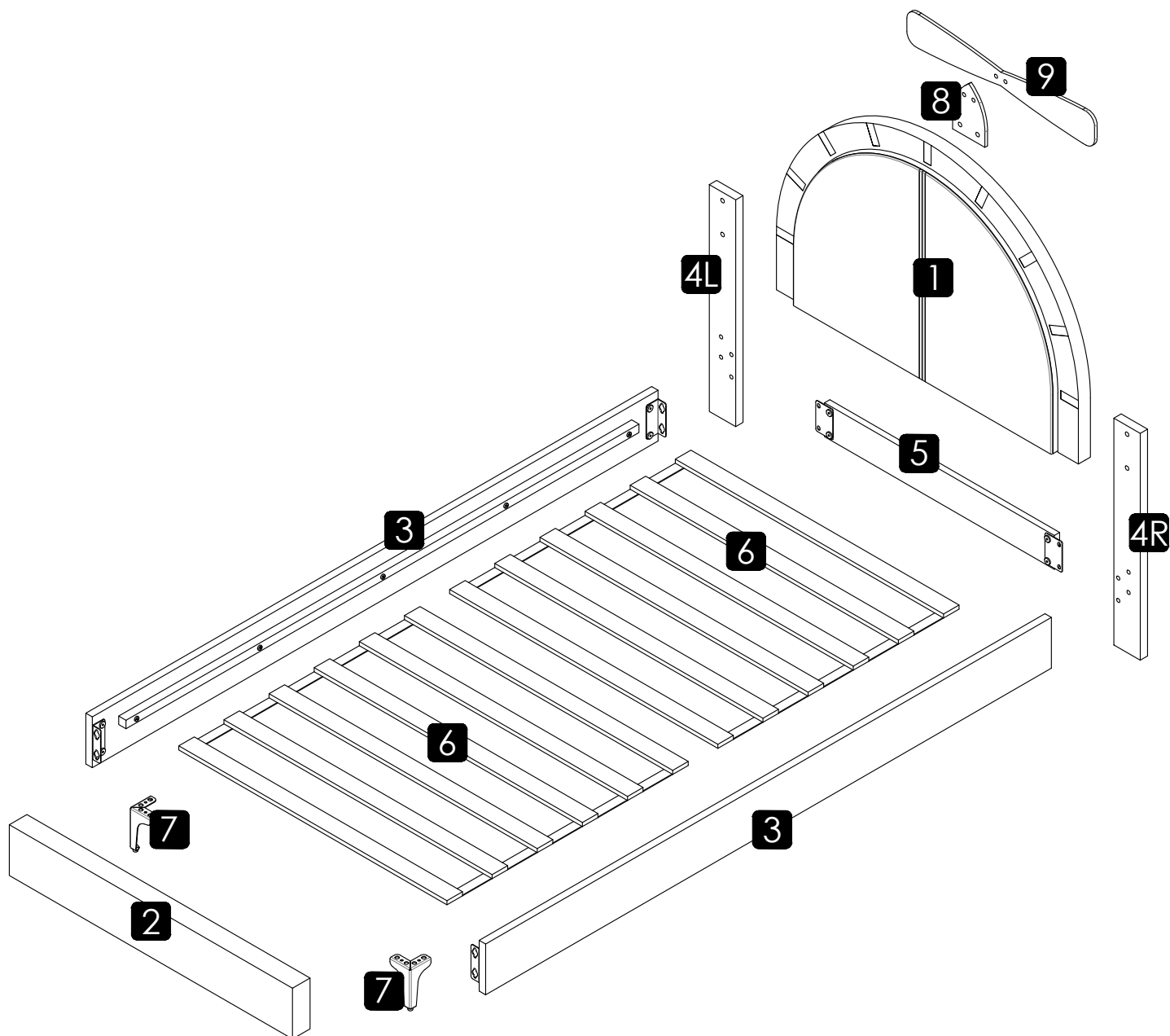

Part List -WF323256

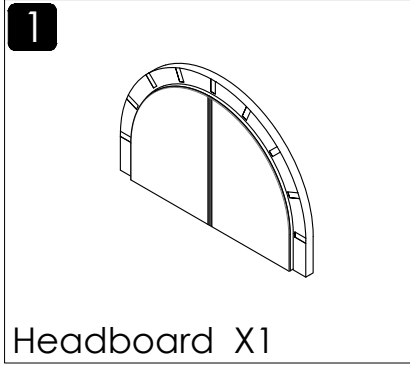

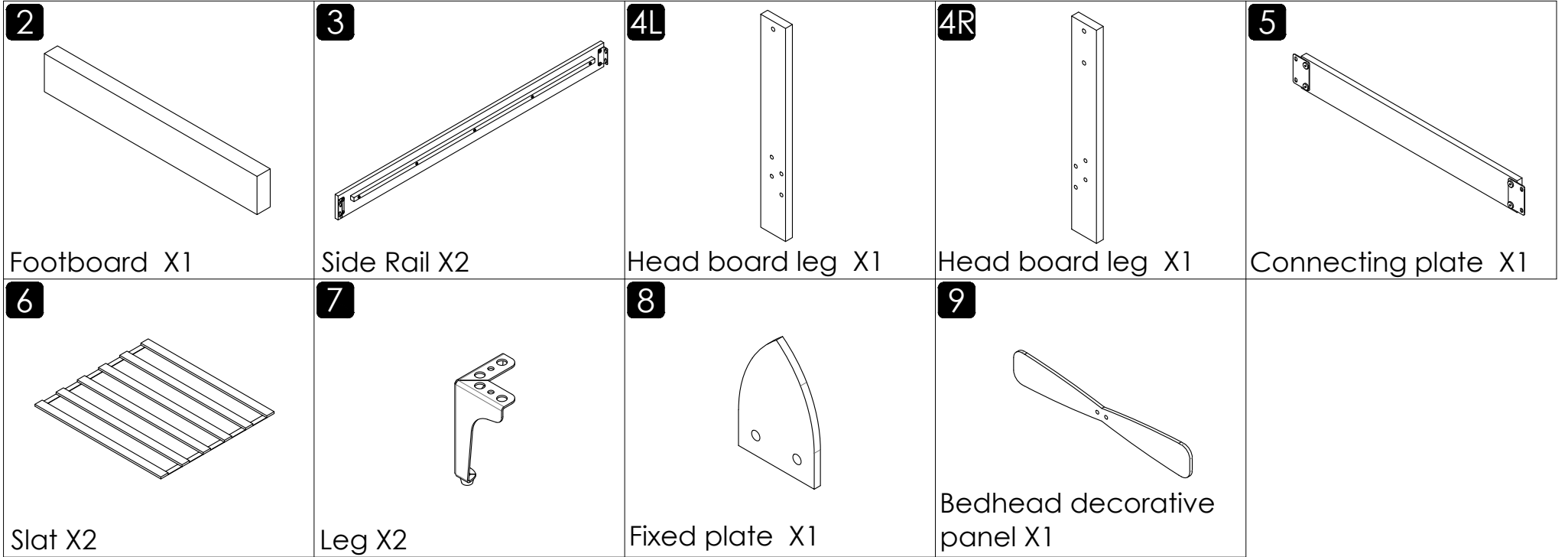

Part List -WF323266

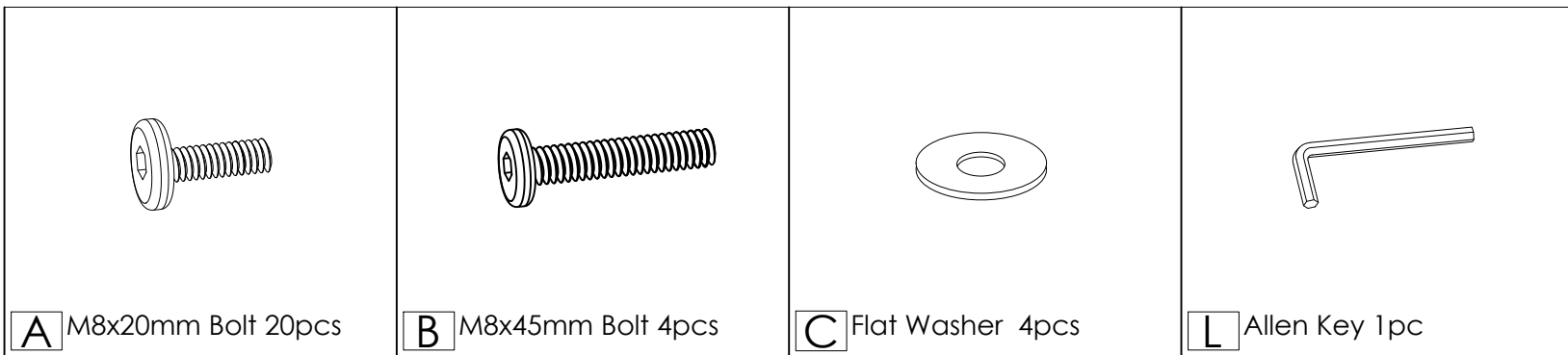

Hardware List-WF323266



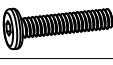
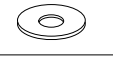

Step 1

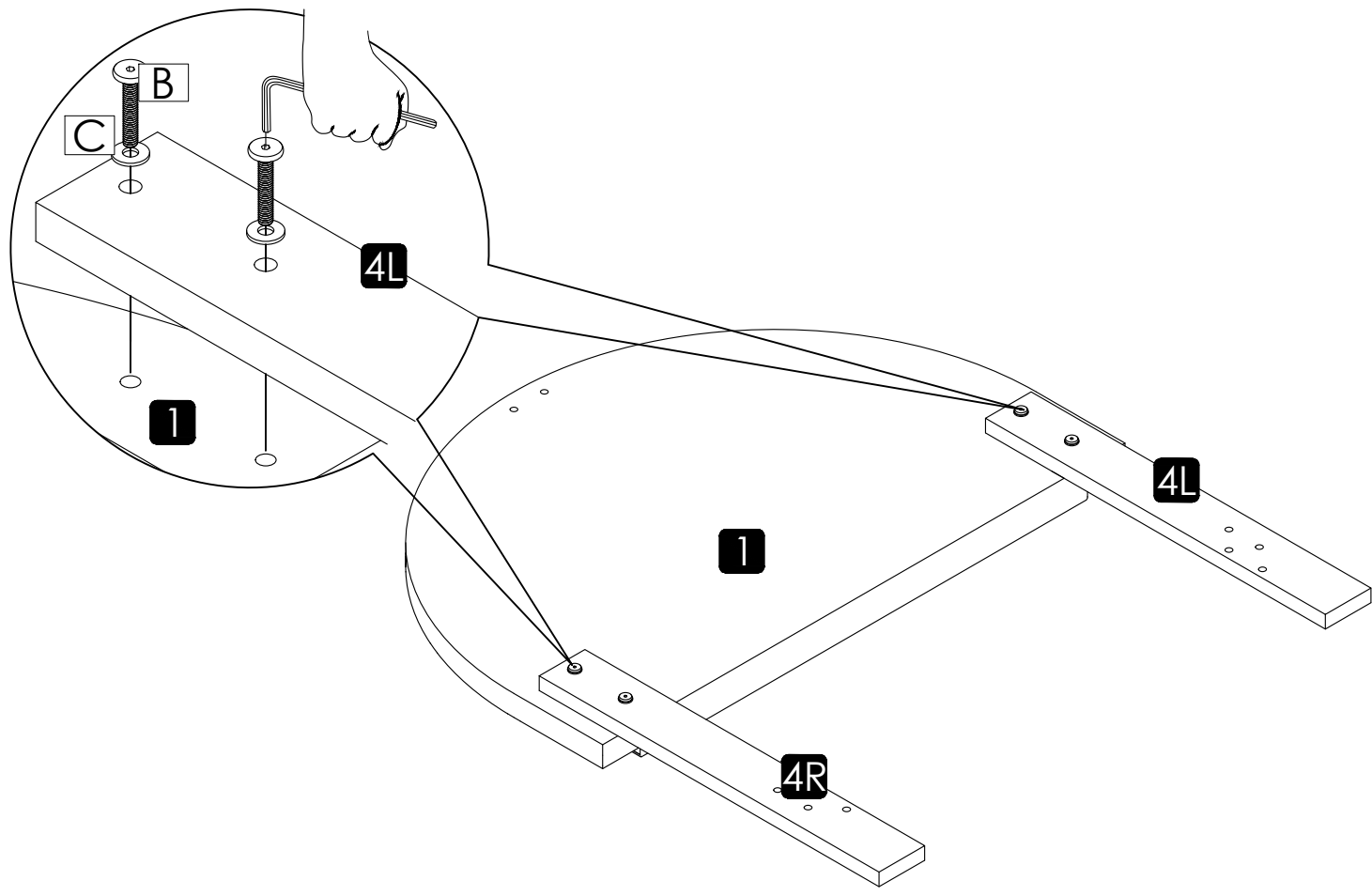
- B**  4pcs
- C**  4pcs
- L**  1pc



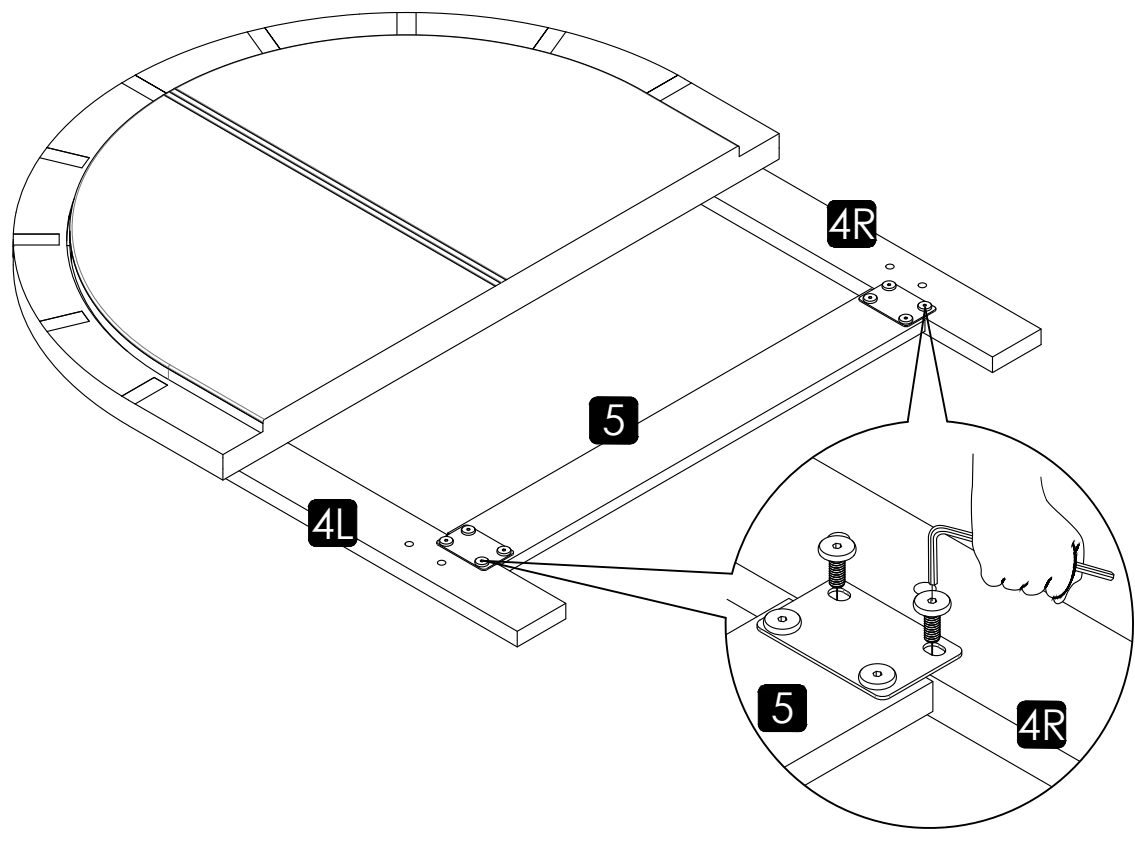

Step 2

- A**  4pcs
- L**  1pc



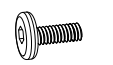

Step 3

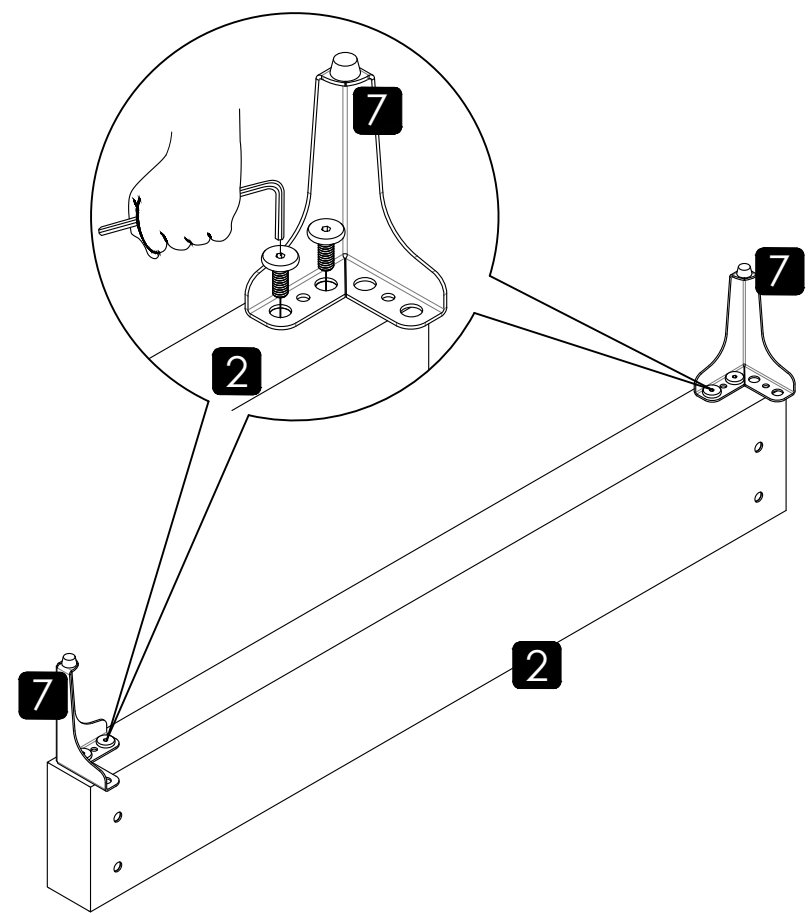
- A**  4pcs
- L**  1pc



Step 4

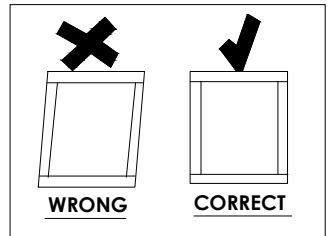
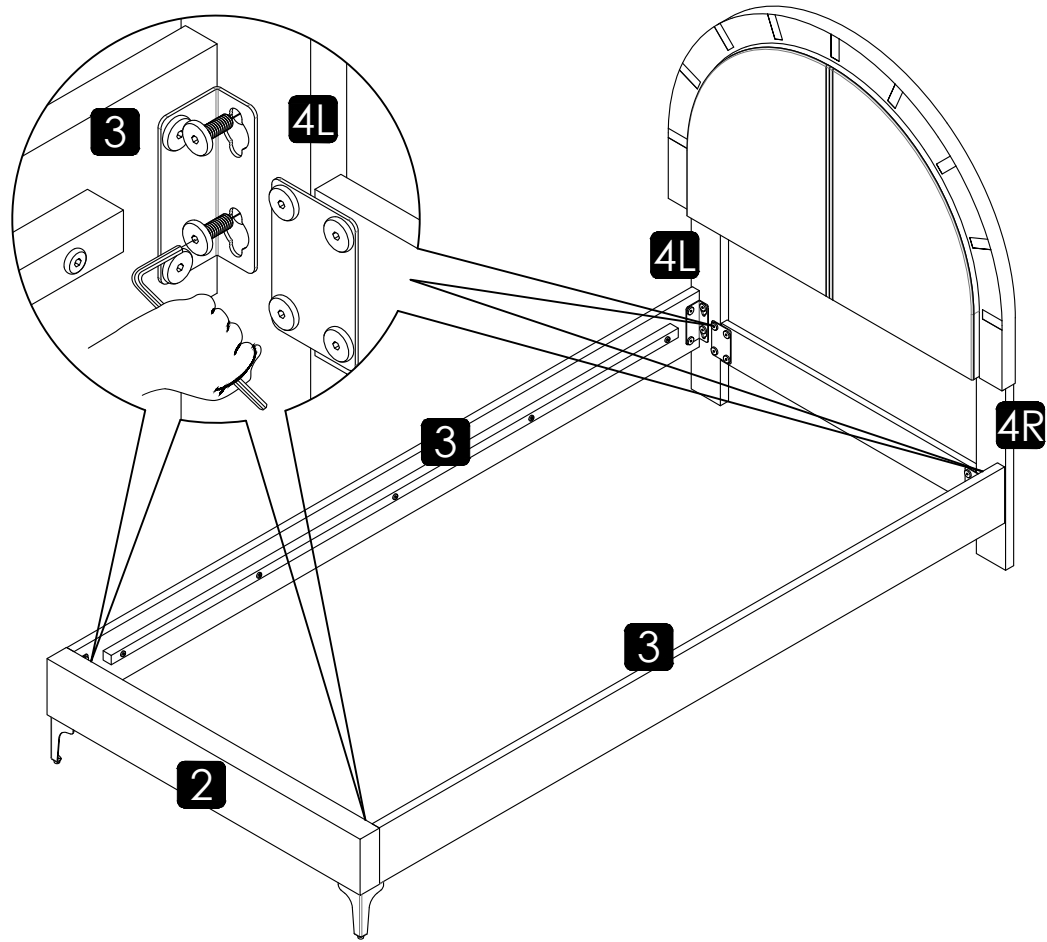

- A  8pcs
- L  1pc

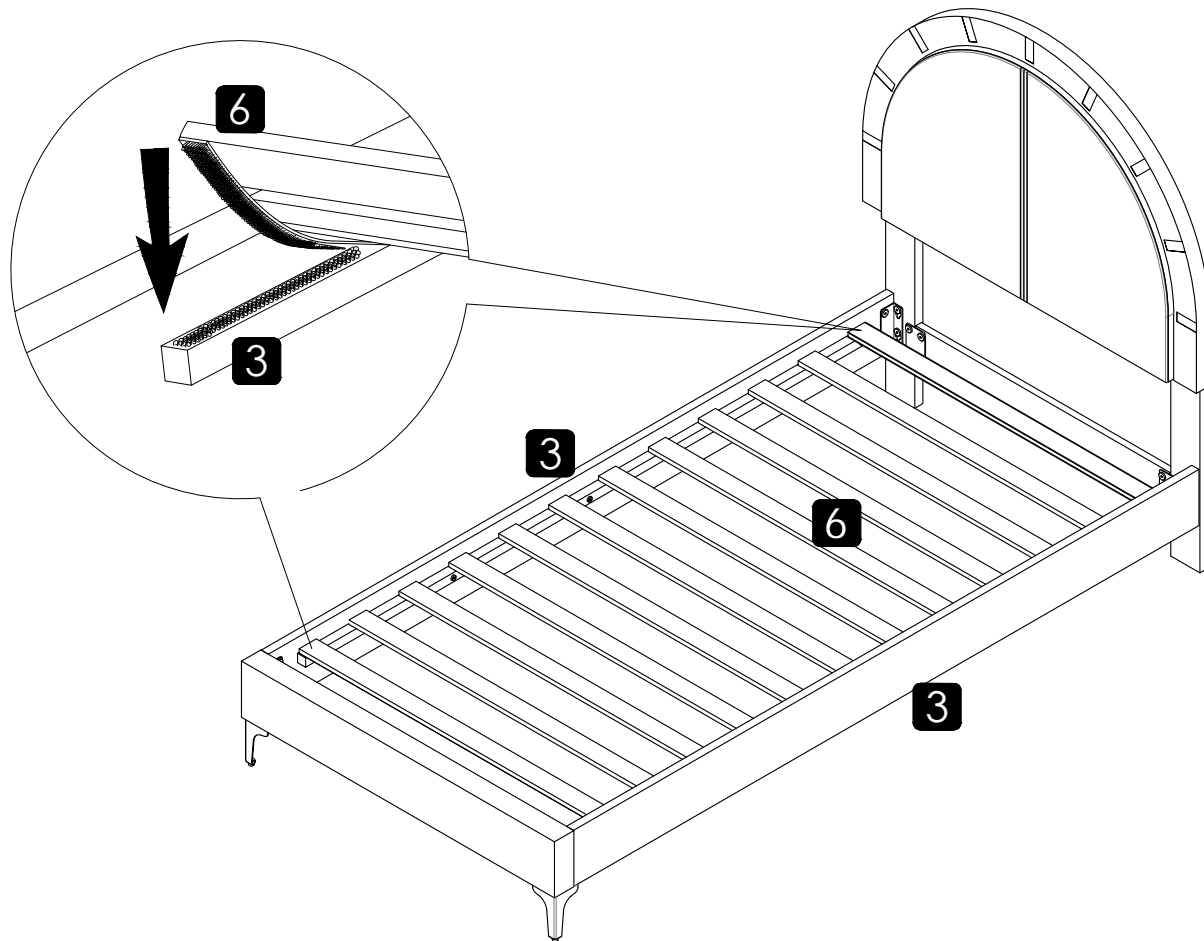

Step 5



Step 6

- A  4pcs
- L  1pc

