

DIMENSIONS

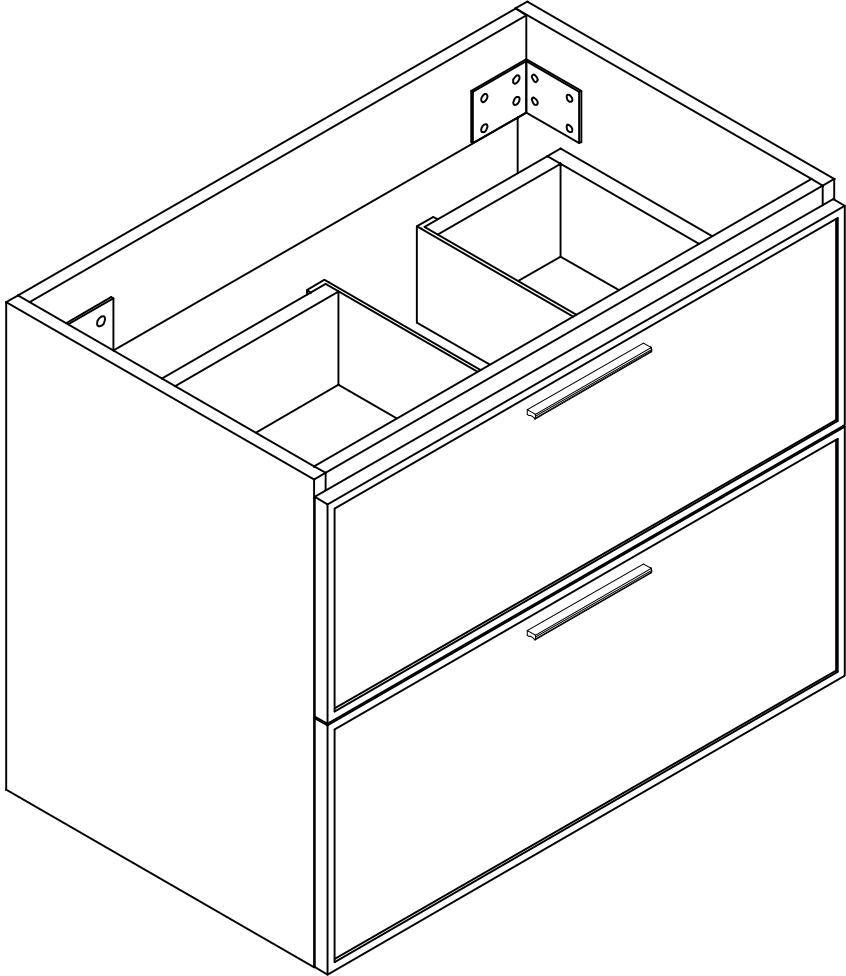

YOU MAY NEED (NOT SUPPLY)

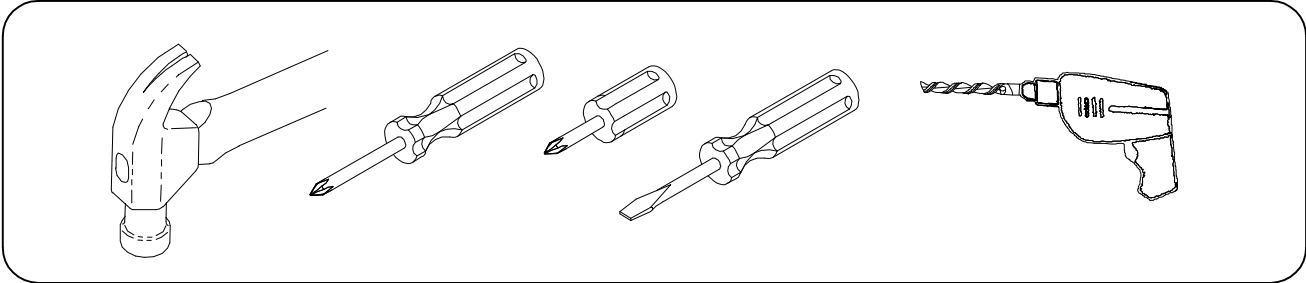



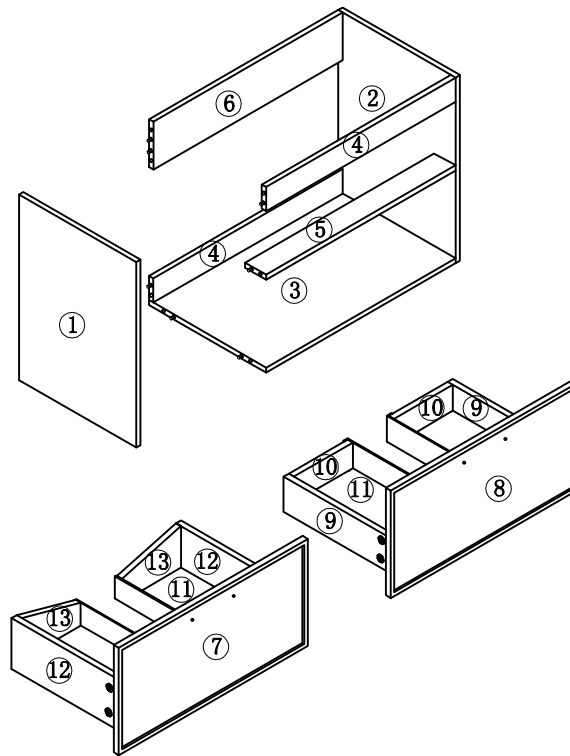







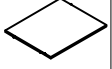

ASSEMBLY DIAGRAM

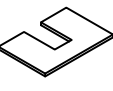











PARTS LIST

PARTS LIST

NO	DESCRIPTION	QTY	NO	DESCRIPTION	QTY
①	Left side panel 	1	⑧	Upper drawer front panel 	1
②	Right side panel 	1	⑨	Upper drawer side panel 	2
③	Bottom panel 	1	⑩	Upper drawer rear panel 	2
④	Long front and rear panel 	2	⑪	Drawers bottom panel 	2
⑤	Front middle panel 	1	⑫	Lower drawer side panel 	2
⑥	Upper back panel 	1	⑬	Lower drawer rear panel 	2
⑦	Lower drawer front panel 	1			

PARTS LIST

HARDWARE LIST



NO	DESCRIPTION	QTY	NO	DESCRIPTION	QTY
A	Three-in-one eccentric wheel 	42	G	4*23mm screw 	4
B	Three-in-one connecting rod 	42	H	Drawer handle 	2
C	Three-in-one sticker 	42	I	White angle bracket 	2
D	8*40mm wood dowel pins 	22	J	Drawer U-shaped plastic 	2
E	Drawer slides 	4			
F	4*16mm screw 	60			

CAUTION:

Please confirm the parts list before installation

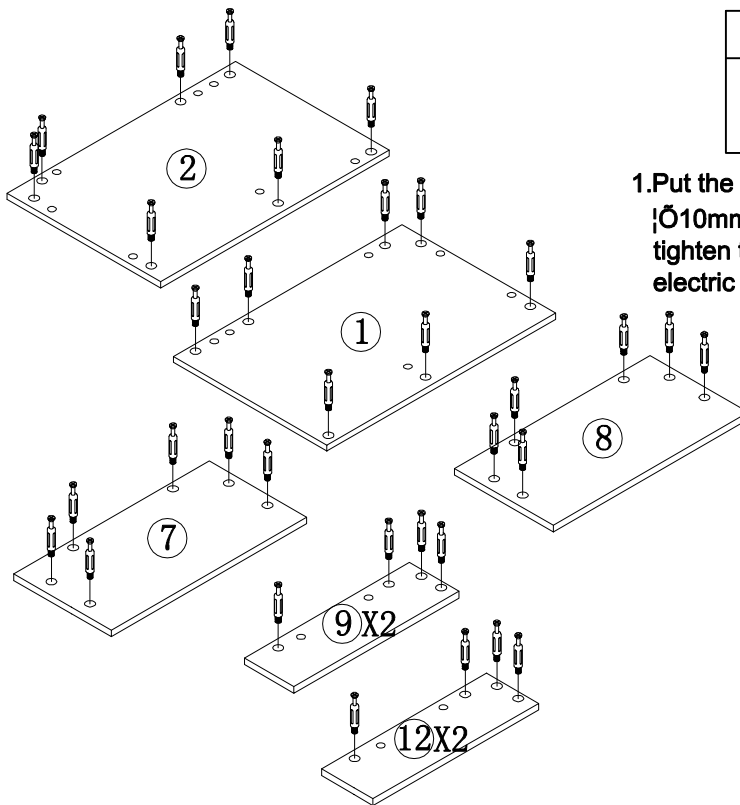
STEP 1



HARDWARE LIST	
Three-in-one connecting rod B  42 PCS	

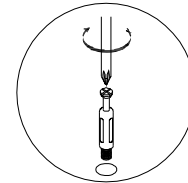

1. Put the three-in-one connecting rod in the $\varnothing 10\text{mm}$ hole of the following panels and tighten them with a cross screwdriver or an electric tool.

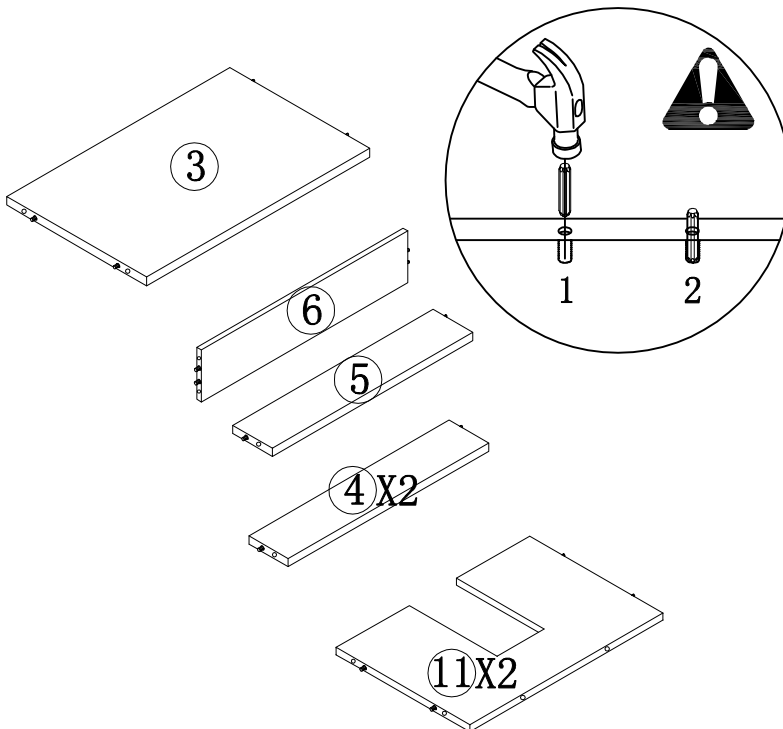

STEP 2



1. Strike the $\varnothing 8 \times 40\text{mm}$ wood dowel pin into the $\varnothing 8\text{mm}$ hole of the above panels with an iron hammer. Please note that the hole of the three-in-one connecting rod should also be 8mm. The hole of the three-in-one connecting rod connects to the hole of $\varnothing 15\text{mm}$ three-in-one eccentric wheel.

HARDWARE LIST	
8*40mm wood dowel pins D  22 PCS	

STEP 3

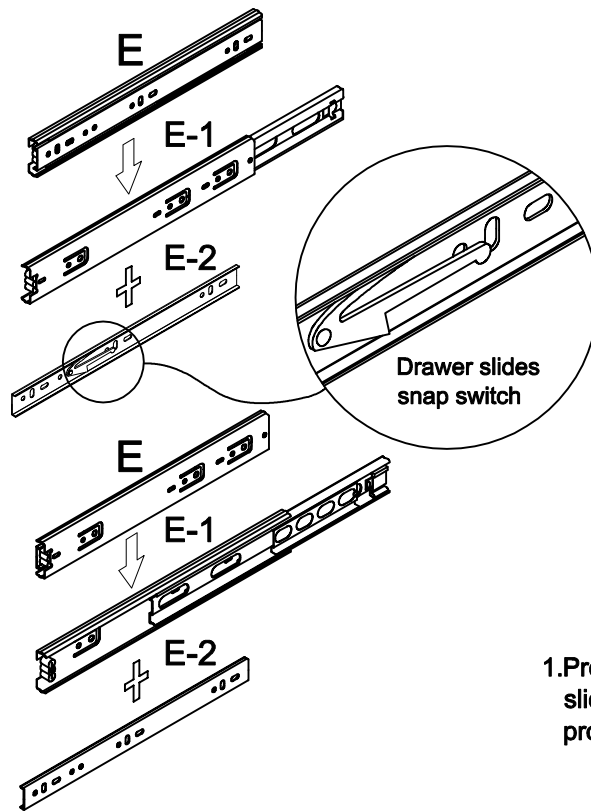

HARDWARE LIST	
Drawer slides	
E 4 PCS	

1. Press the side snap switch, disassemble slide blocks and put them in a place properly for further use.

STEP 4

1. Fix the drawer slide to the side panel with 4*16mm screws.

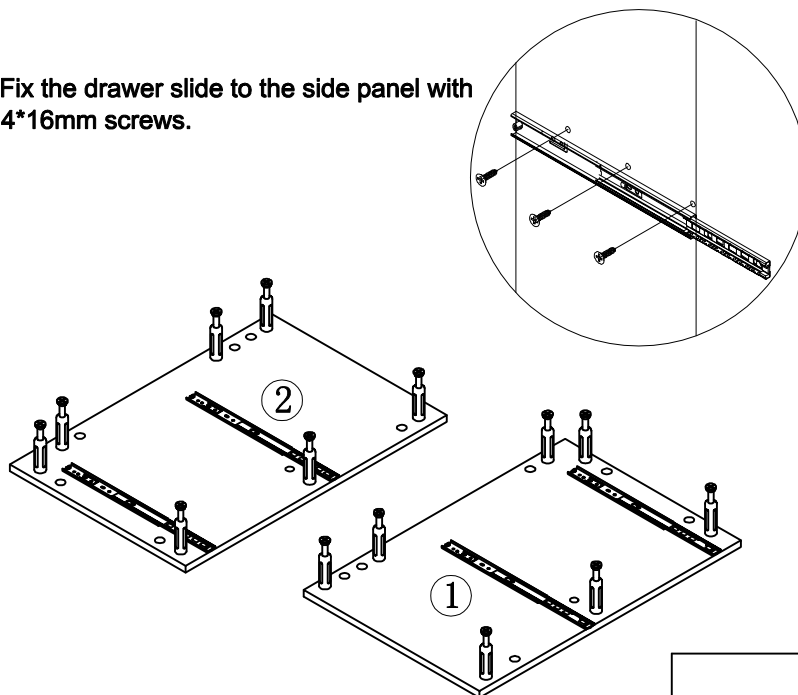

HARDWARE LIST		
4*16mm screw	Drawer slides	
F 12 PCS	E-1 4 PCS	

STEP 5

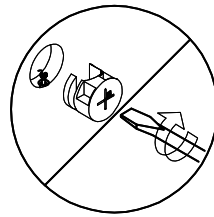
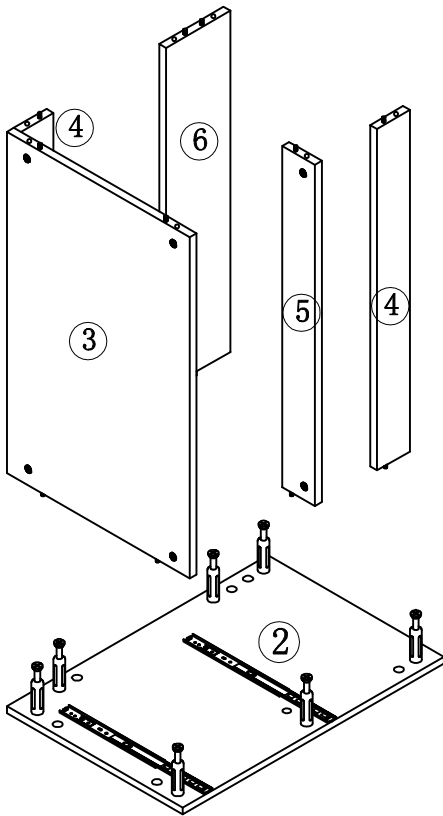

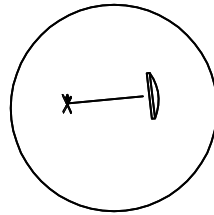

1. Connect No. 3-4-5-6 panel to No.2 panel tightly with the three-in-one eccentric wheel.



2. Cover the mounting hole of the eccentric wheel with a three-in-one sticker.

HARDWARE LIST

Three-in-one eccentric wheel A  7 PCS	Three-in-one sticker C  7 PCS	
--	--	--

STEP 6

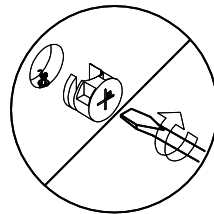
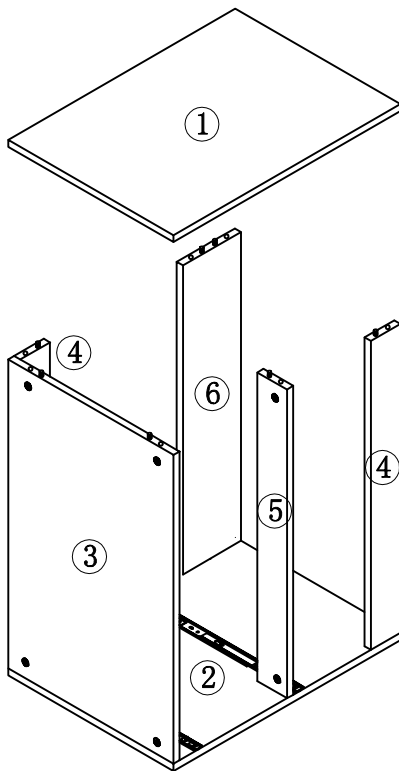

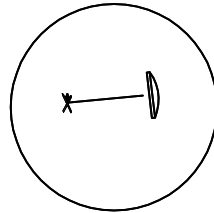

1. Connect No. 1 panel to No. 3-4-5-6 panel tightly with the three-in-one eccentric wheel.



2. Cover the mounting hole of the eccentric wheel with a three-in-one sticker.

HARDWARE LIST

Three-in-one eccentric wheel A  7 PCS	Three-in-one sticker C  7 PCS	
---	---	---

STEP 7

1. Install the Drawer U-shaped plastic with 4*16mm screws.

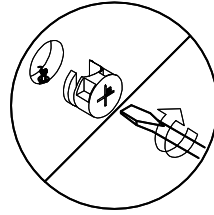
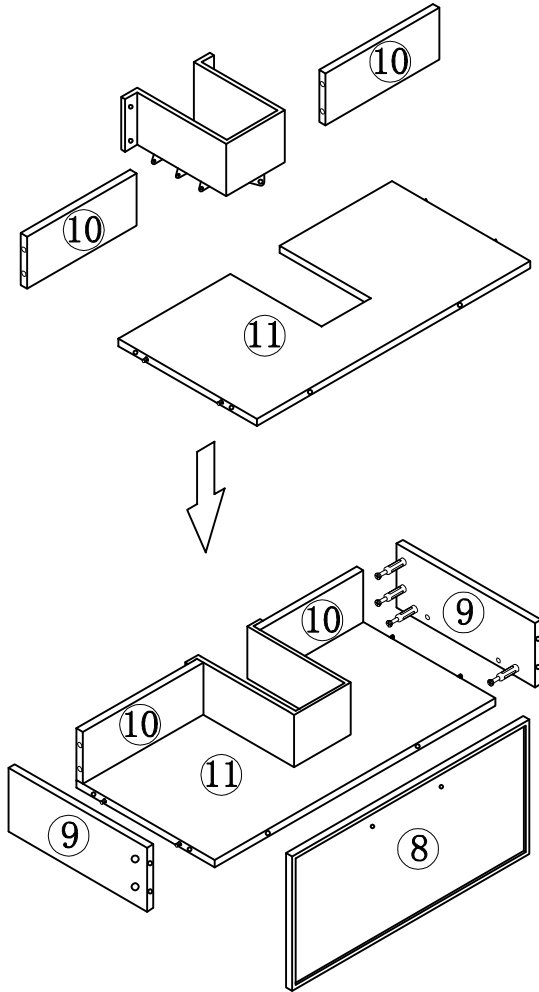



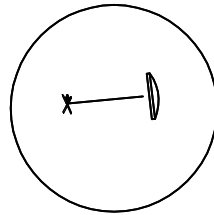

1. Install No. 8-9-10-11 panels with the three-in-one eccentric wheel tightly.

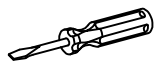

2. Cover the mounting hole of the eccentric wheel with a three-in-one sticker.

HARDWARE LIST

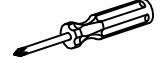

Three-in-one eccentric wheel A  14 PCS	Three-in-one sticker C  14 PCS	
Drawer U-shaped plastic J  1 PCS	4*16mm screw F  10 PCS	

STEP 8

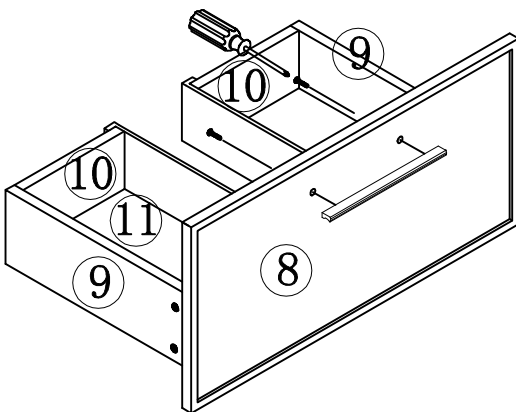
1. Install the drawer handle with 4*23mm screws.

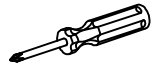

HARDWARE LIST

4*23mm screw G  2 PCS	Drawer handle H  1 PCS	
---	--	---

STEP 9

1. Install the Drawer U-shaped plastic with 4*16mm screws.

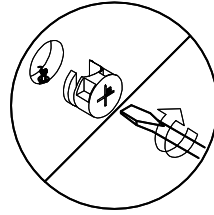
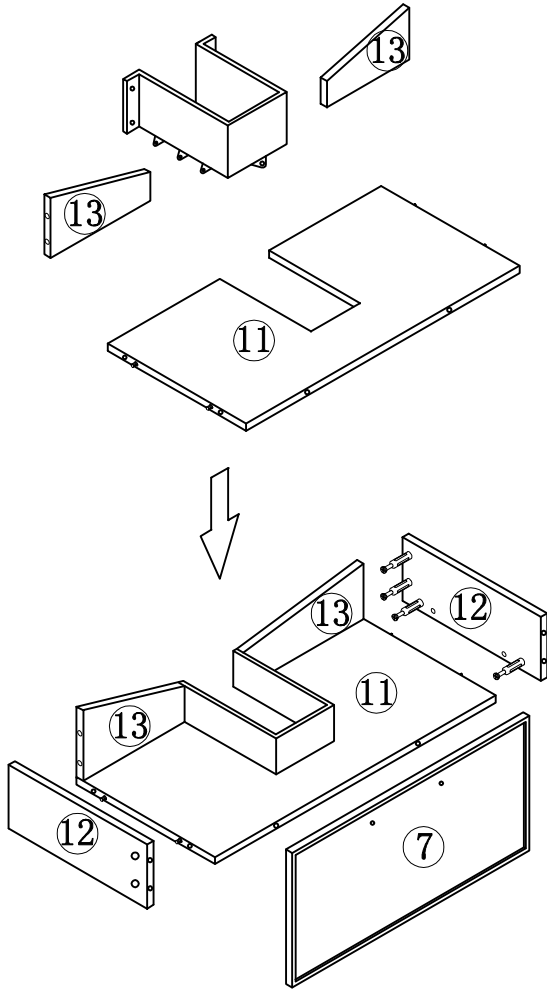



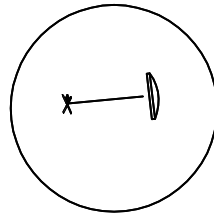

1. Install No. 7-11-12-13 panels with the three-in-one eccentric wheel tightly.

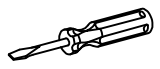

2. Cover the mounting hole of the eccentric wheel with a three-in-one sticker.

HARDWARE LIST

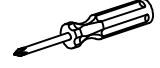

Three-in-one eccentric wheel A  14 PCS	Three-in-one sticker C  14 PCS	
Drawer U-shaped plastic J  1 PCS	4*16mm screw F  10 PCS	

STEP 10

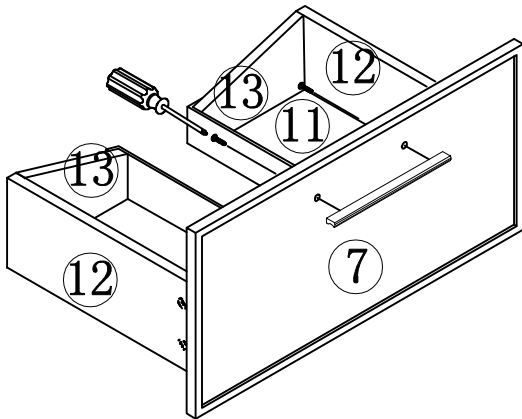
1. Install the drawer handle with 4*23mm screws.



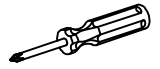

HARDWARE LIST

4*23mm screw G  2 PCS	Drawer handle H  1 PCS	
---	--	---

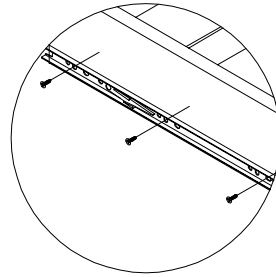
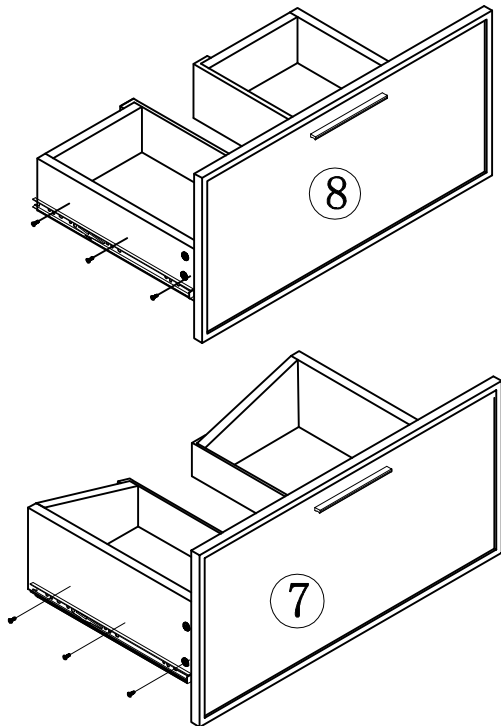
STEP 11

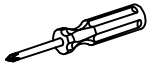

1.Lock the spare drawer slide block to the drawer.

HARDWARE LIST		
4*16mm screw	Drawer slides	
F  12 PCS	E-2  4 PCS	

STEP 12

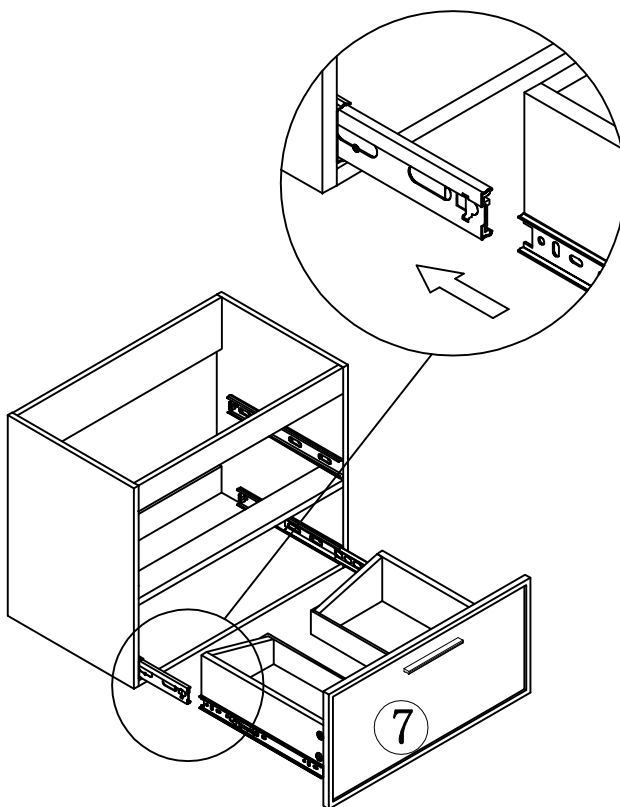

1.Align slide block with the trough on the guide rail, press the snap switch and press it forward to install the drawer.

STEP 13

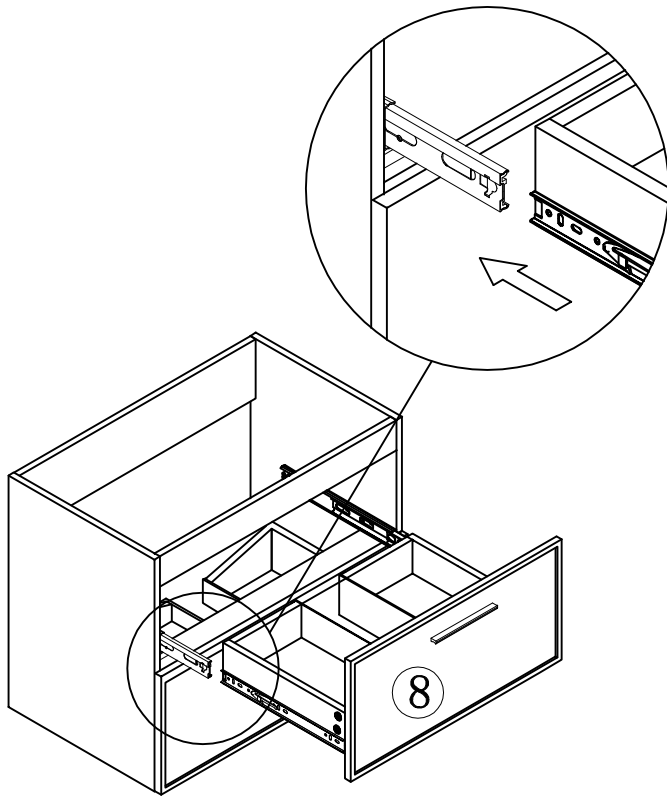

1. Align slide block with the trough on the guide rail, press the snap switch and press it forward to install the drawer.

STEP 14

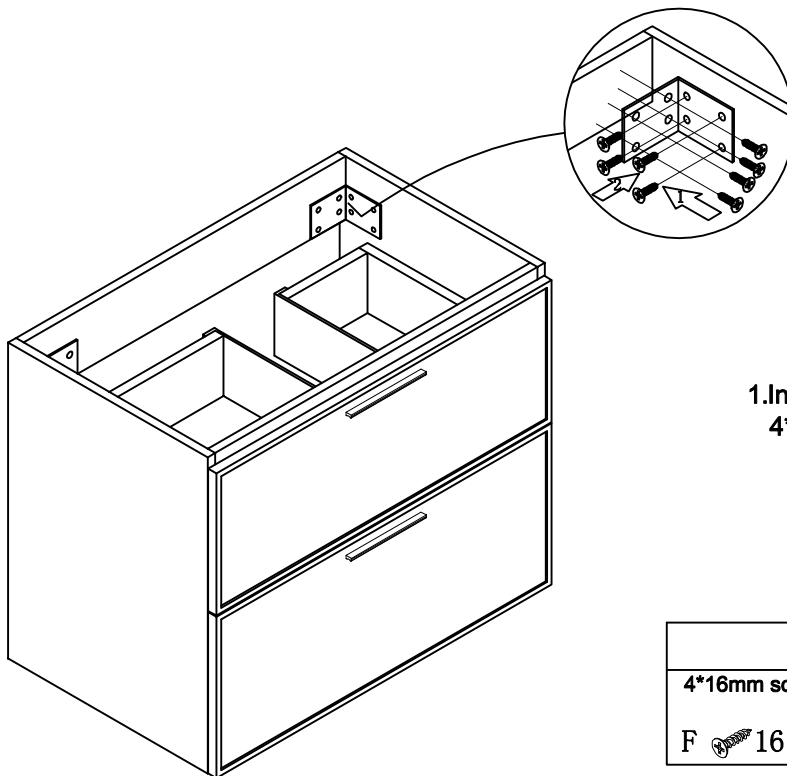

1. Install white angle bracket with 4*16mm screws.

HARDWARE LIST

4*16mm screw

White angle bracket

F  16 PCS

I  2 PCS

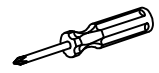



Choking hazard-Small Parts : This unit contains small parts, not for children under 3 years.

Tip-over hazard : Secure finished unit to wall stud using L-Bracket and wall screw (#10*1.5"W/out provided). If a wall stud is not neccessible , Consult your local hardware store for appropriate mounting hardware . Failure to properly install will result in product collapse or tip-over. Serious injury can occur .