

# ASSEMBLY INSTRUCTIONS

INSTRUCTIONS DE MONTAGE

## L SHAPED TWIN/TWIN BED WITH 3 DRAWERS

LIT JUMEAUX/JUMEAUX EN FORME DE L AVEC 3 TIROIRS

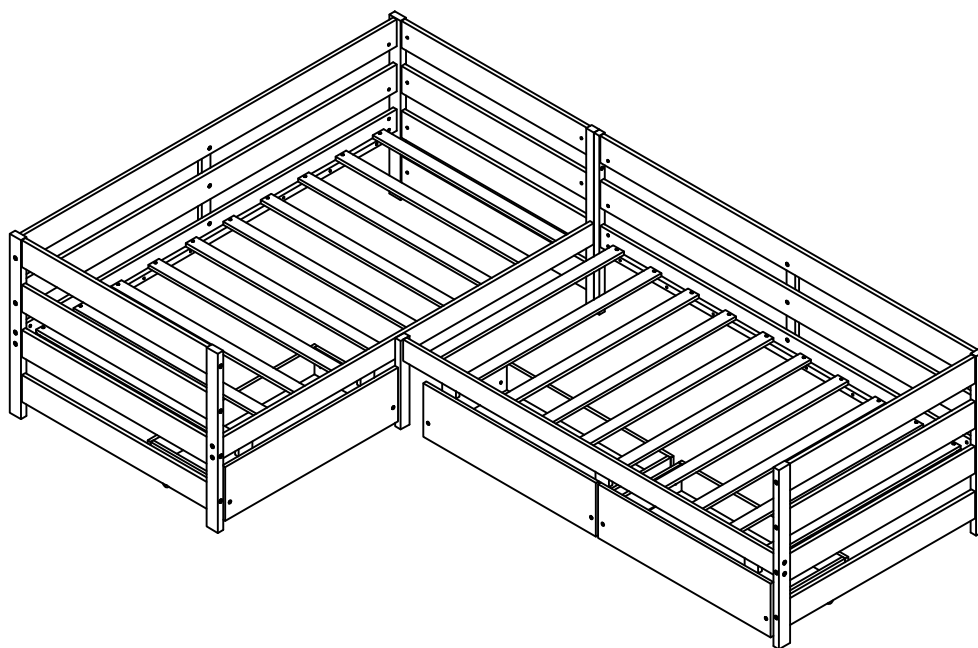





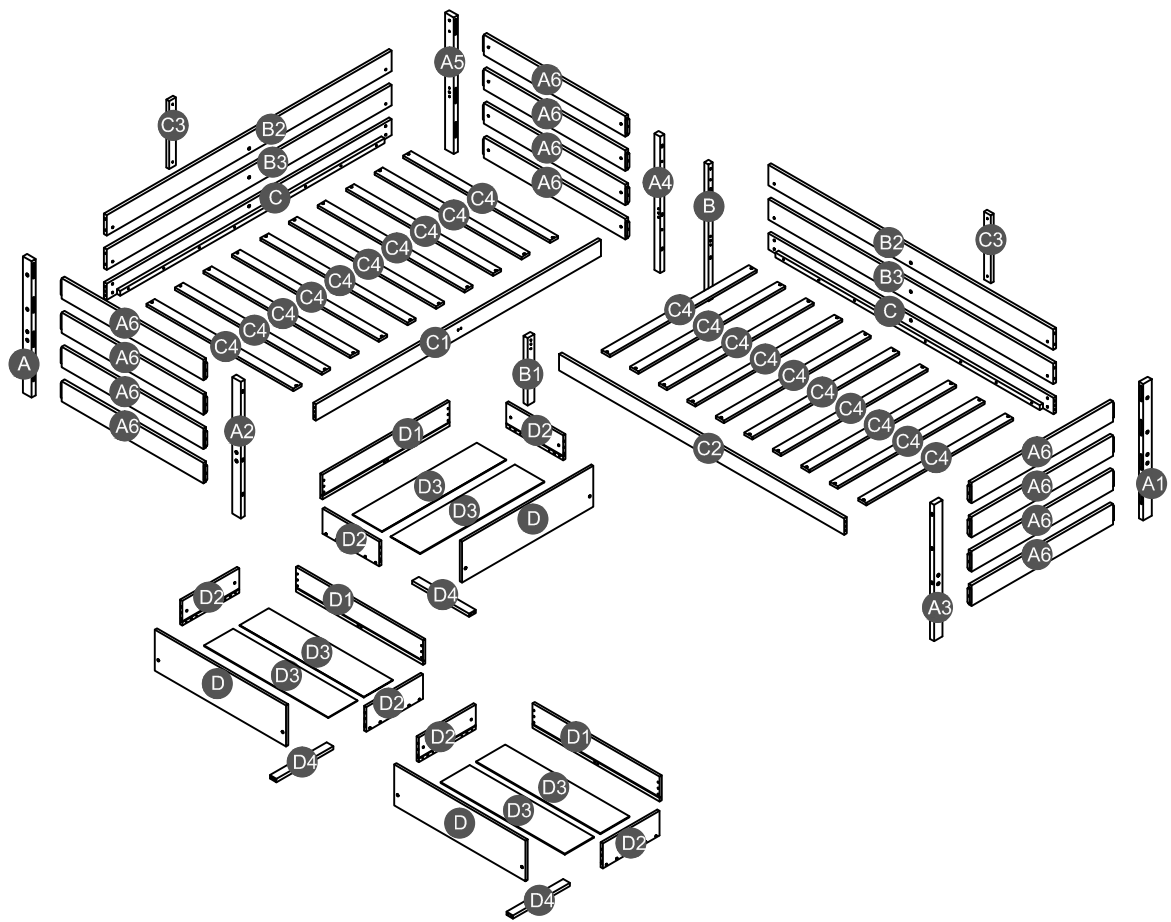

# Detail View

## Vue Détaillée



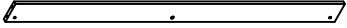
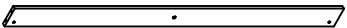









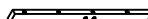

## Part list (Box 1 )

Liste des pièces (Boîte 1 )

<p><b>A4</b></p>  <p>Leg (right front) - 1pc Pied (Avant droit)</p>	<p><b>B</b></p>  <p>Leg support (back) - 1pc Support de jambe (arrière)</p>	<p><b>B2</b></p>  <p>Upper long guard rail- 2pcs Garde-corps long supérieur</p>
<p><b>B3</b></p>  <p>Middle long guard rail - 2pcs Garde-corps mi-long</p>	<p><b>C</b></p>  <p>Side rail (back) - 2pcs Rail latéral (arrière)</p>	<p><b>C1</b></p>  <p>Side rail (front) - 1pc Rail latéral (avant)</p>
<p><b>C2</b></p>  <p>Side rail (front) - 1pc Rail latéral (avant)</p>	<p><b>C4</b></p>  <p>Slats - 20pcs Lattes</p>	











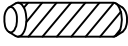

## Part list & Hardware list (Box 2)

Liste des pièces & liste du matériel (Boîte 2)

<p><b>A</b></p>  <p>Leg (left back) - 1pc Pied (arrière gauche)</p>	<p><b>A1</b></p>  <p>Leg (right back) - 1pc Pied (arrière droit)</p>	<p><b>A2</b></p>  <p>Leg (left front) - 1pc Pied (avant gauche)</p>
<p><b>A3</b></p>  <p>Leg (right front) - 1pc Pied (avant droit)</p>	<p><b>A5</b></p>  <p>Leg (right back) - 1pc Pied (arrière droit)</p>	<p><b>A6</b></p>  <p>Horizontal bar HB/FB - 12pcs Barre horizontale HB/FB</p>
<p><b>B1</b></p>  <p>Leg support (front) - 1pc Support de jambe (avant)</p>	<p><b>C3</b></p>  <p>Vertical guard rail - 2pcs Garde-corps vertical</p>	<p><b>D</b></p>  <p>Front drawer panel - 3pcs Panneau de tiroir avant</p>
<p><b>D1</b></p>  <p>Back drawer panel - 3pcs Panneau de tiroir arrière</p>	<p><b>D2</b></p>  <p>Side drawer panel - 6pcs Panneau de tiroir latéral</p>	<p><b>D3</b></p>  <p>Drawer bottom - 6pcs Fond de tiroir</p>
<p><b>D4</b></p>  <p>Support rail of drawer - 3pcs Rail de support du tiroir</p>		

## Hardware List (Box 2 )

Liste du matériel (Boîte 2)

<b>1</b>  Ø8*30mm	<b>2</b>  Ø10*40mm	<b>3</b>  Ø10*20mm
Wood dowel (44pcs) Cheville en bois	Wood dowel (8pcs) Cheville en bois	Wood dowel (12pcs) Cheville en bois
<b>4</b>  (Ø15)1/4"*100mm	<b>5</b>  (Ø15)1/4"*80mm	<b>6</b>  (Ø12)1/4"*60mm
Hex-Head bolts (20pcs) Boulons à tête hexagonale	Hex-Head bolts (28pcs) Boulons à tête hexagonale	Hex-Head bolts (14pcs) Boulons à tête hexagonale
<b>7</b>  (Ø12)1/4"*30mm	<b>8</b>  1/4"*15 (9.5mm)	<b>9</b>  (1/4")4.5*58mm
Hex-Head bolts (6pcs) Boulons à tête hexagonale	Horizontal-Hole bolts(60pcs) Boulons à trou horizontal	Allen key (1pc) Clé Allen
<b>10</b>  80*40*19 mm	<b>11</b>  100*52*20mm	<b>12</b>  (Ø12)1/4"*40mm
Drawer stopper (5pcs) Butée de tiroir	Wheels (12pcs) Roues	Hex-Head bolts (2pcs) Boulons à tête hexagonale
<b>13</b>  Ø4*30mm Wood screws (74pcs) Vis		

### ASSEMBLY TOOLS REQUIRED ( NOT INCLUDED )

OUTILS D'ASSEMBLAGE REQUIS (NON INCLUS)

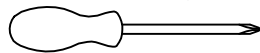



( Phillip head screwdriver )



PLEASE BE CAREFUL DO NOT DAMAGE THE HOLE POSITION WHEN YOU USE POWER TOOLS !

NE PAS UTILISER DES OUTILS ÉLECTRIQUES POUR ASSEMBLER CE PRODUIT !

**STEP 1:**  
ÉTAPE

<b>4</b>		<b>8</b>	
<b>16PCS</b>		<b>16PCS</b>	

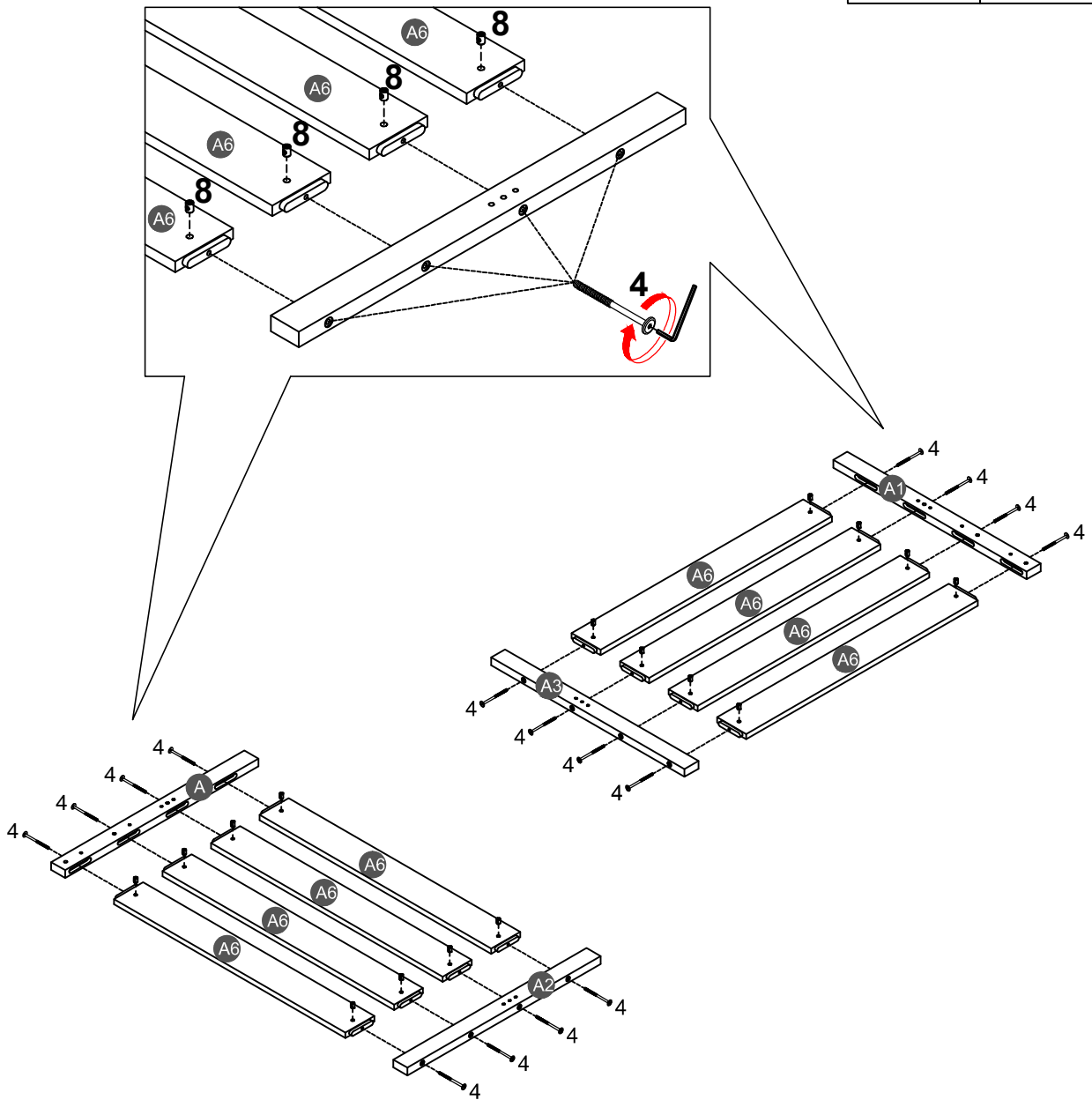

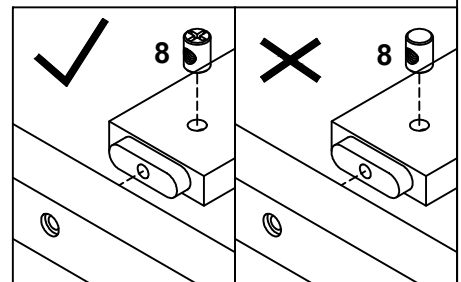

Note: Part 8 will face up with the "x" mark on it, otherwise it cannot be tightened

Remarque: La pièce 8 sera face vers le haut avec la marque "x", sinon elle ne peut pas être serrée.



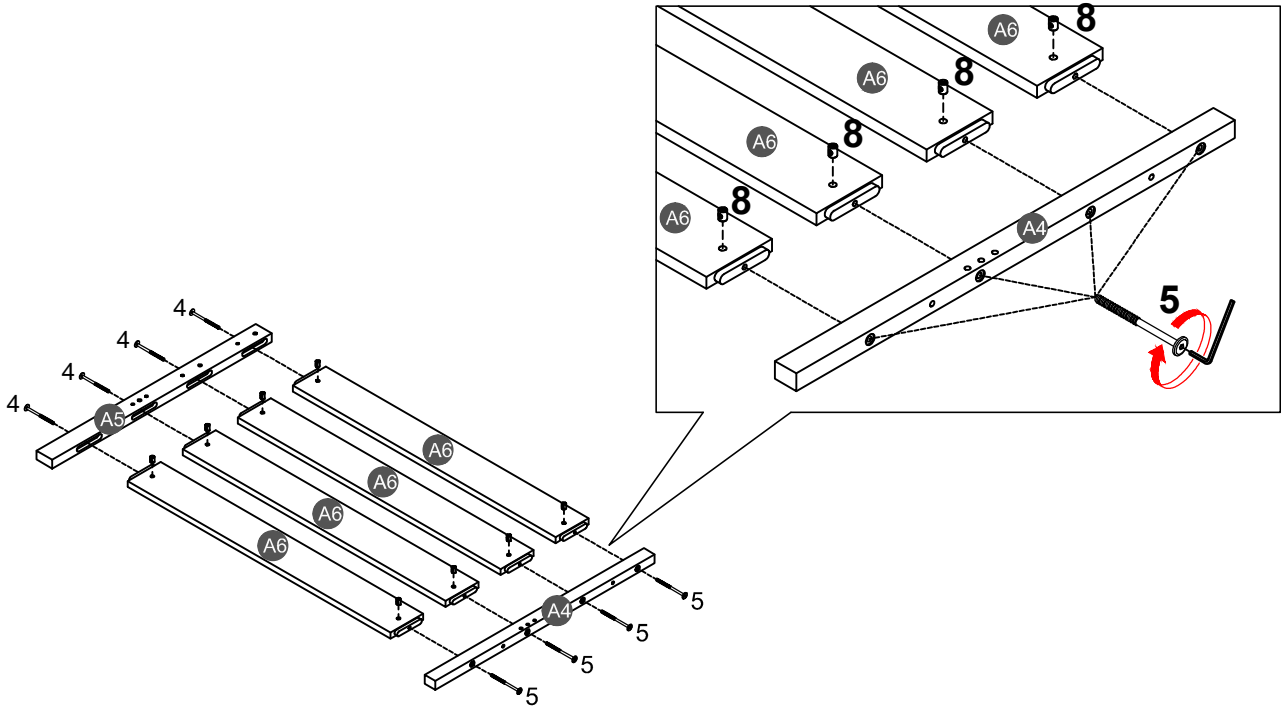

**STEP 2:**  
ÉTAPE

<b>4</b>		<b>5</b>		<b>8</b>	
<b>4PCS</b>		<b>4PCS</b>		<b>8PCS</b>	



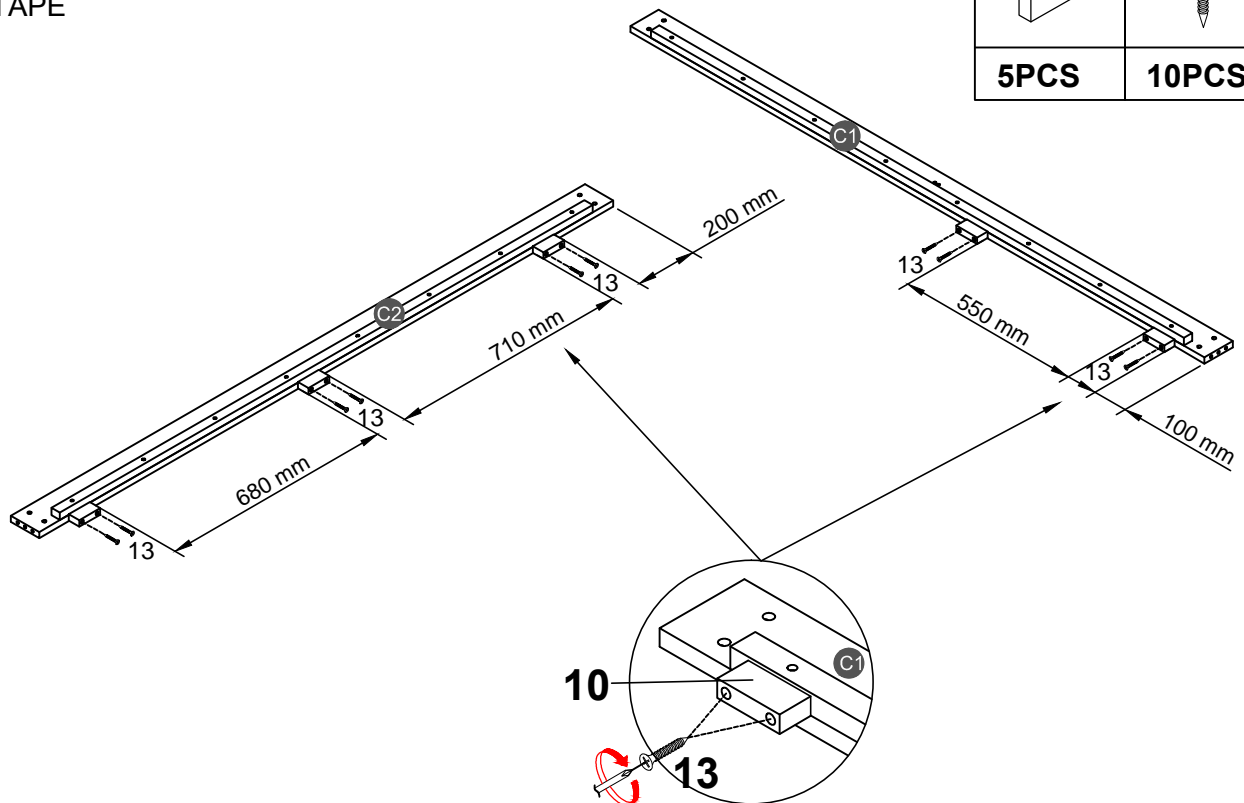

**STEP 3:**  
ÉTAPE

<b>10</b>		<b>13</b>	
<b>5PCS</b>		<b>10PCS</b>	



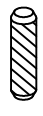

**STEP 4:**  
ÉTAPE

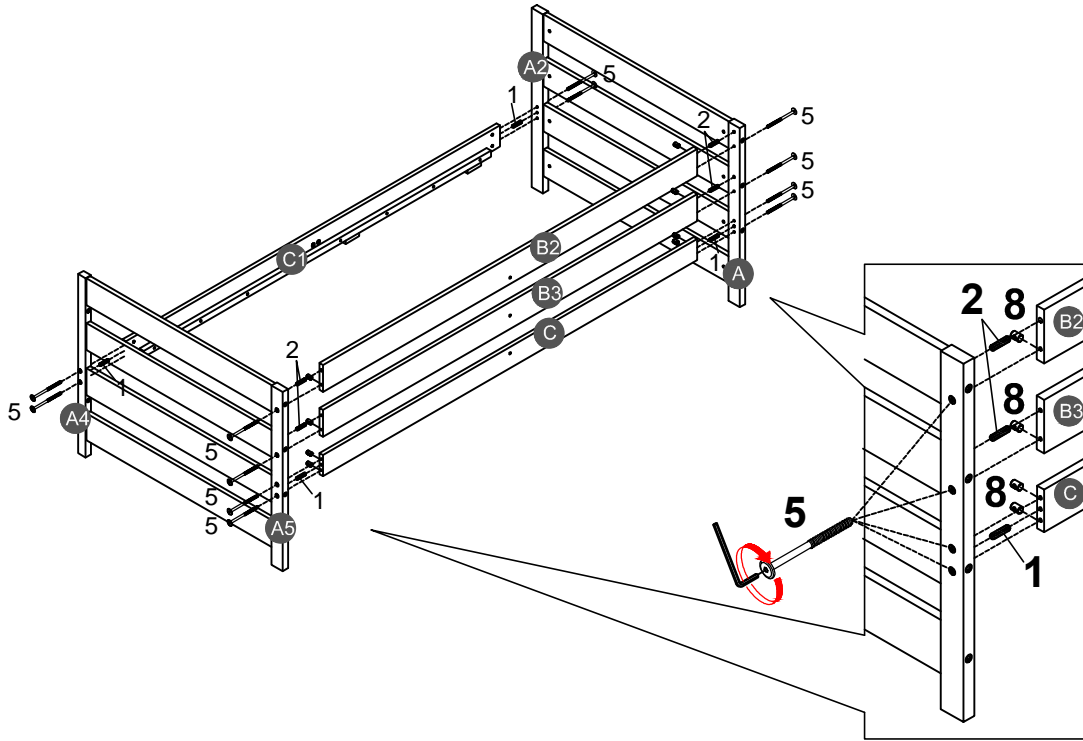
<b>1</b> 	<b>2</b> 	<b>5</b> 
<b>4PCS</b>	<b>4PCS</b>	<b>12PCS</b>
		<b>8</b> 
		<b>12PCS</b>

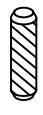

**STEP 5:**  
ÉTAPE

<b>1</b> 	<b>2</b> 	<b>5</b> 
<b>4PCS</b>	<b>4PCS</b>	<b>12PCS</b>
		<b>8</b> 
		<b>12PCS</b>

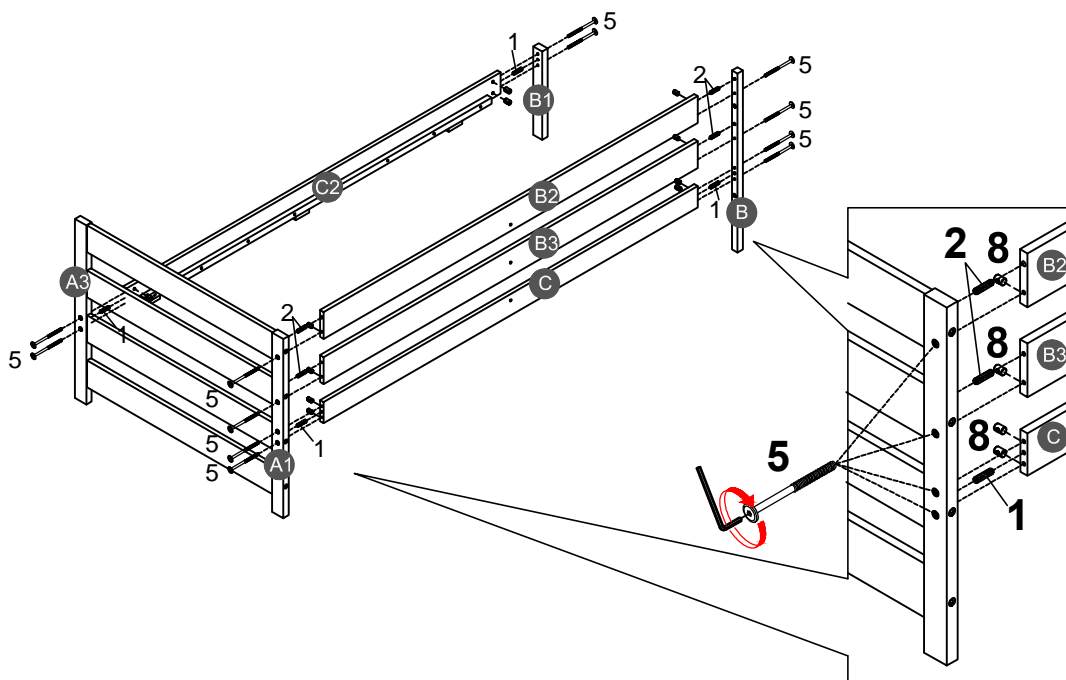

**STEP 6:**  
ÉTAPE

7



6PCS

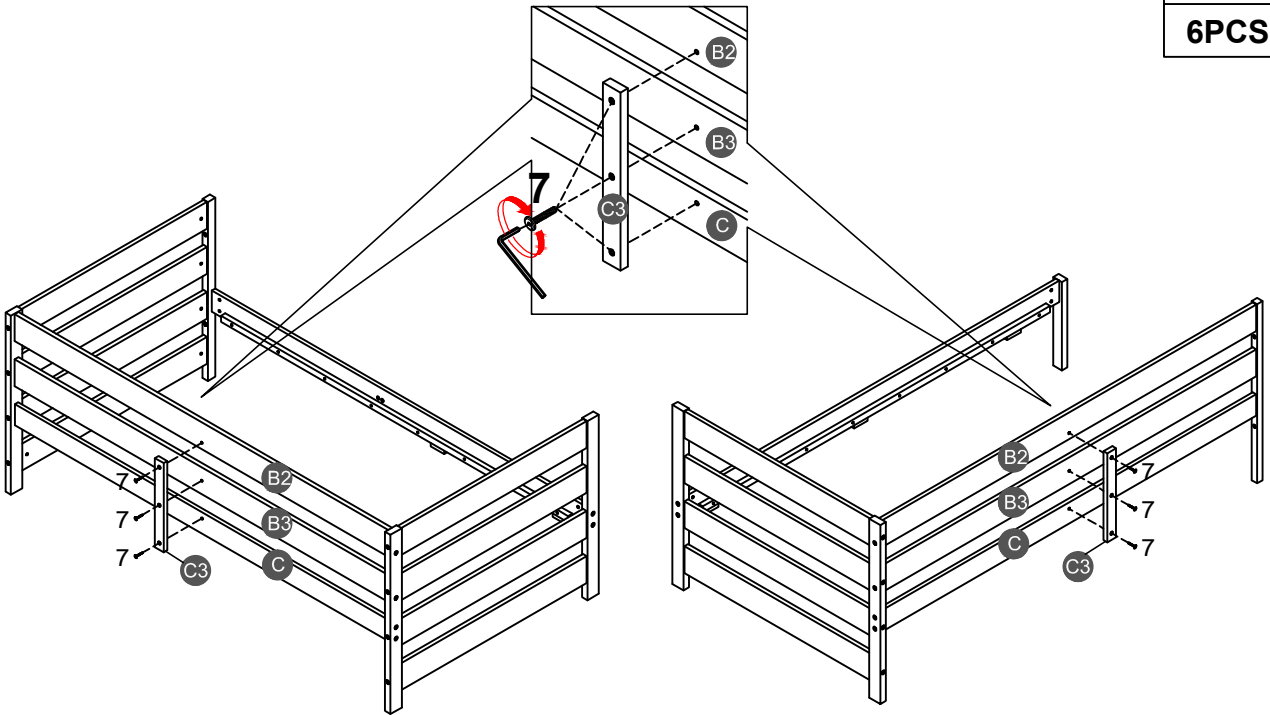

**STEP 7:**  
ÉTAPE

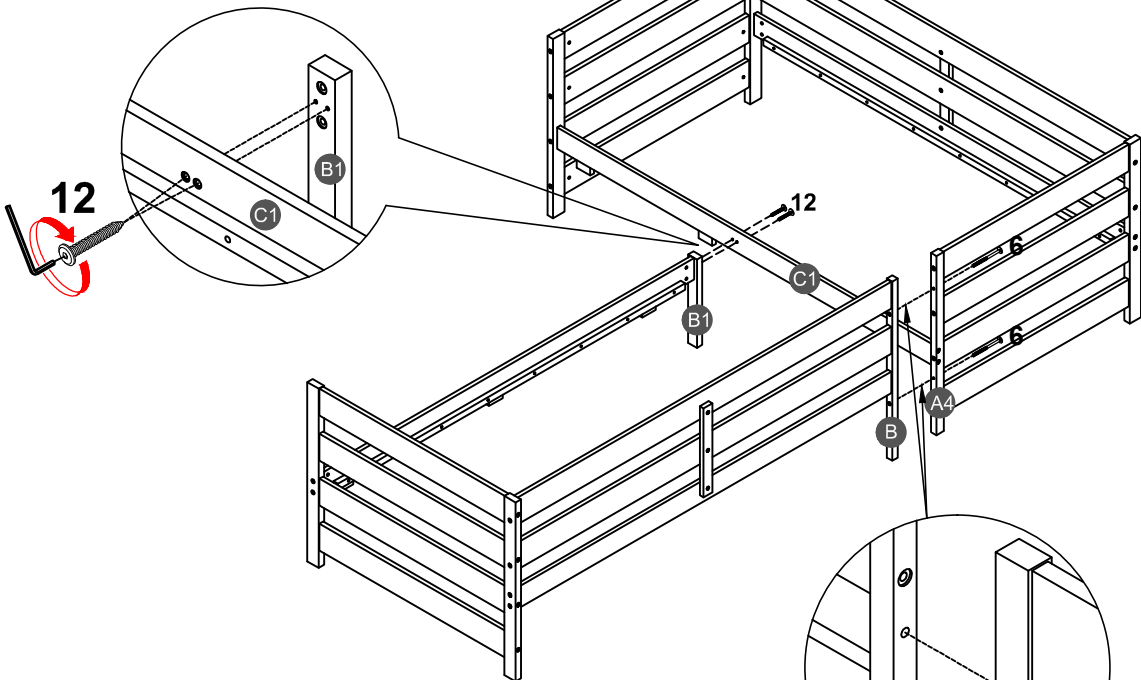

6	12
2PCS	2PCS

## STEP 8:

ÉTAPE

13



40PCS

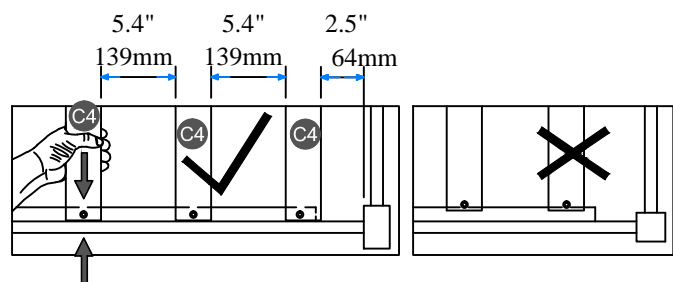
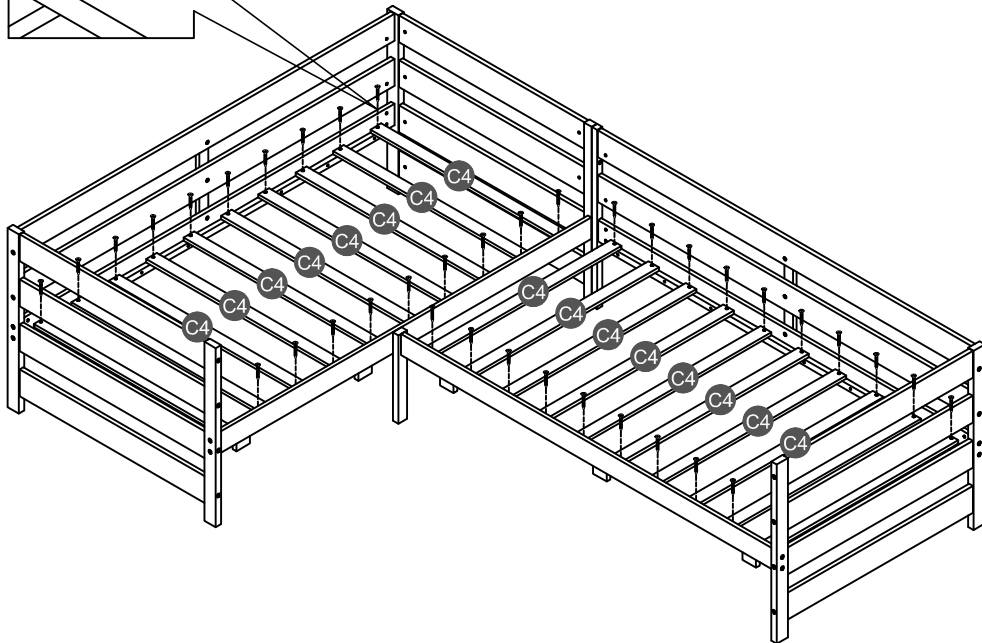
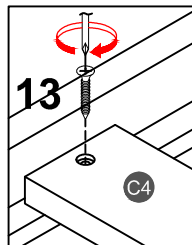



**NOTE:** Please make sure the bed slats close to the side rail before locking the screws to avoid breakage. This step is required for both the left and right sides. Moreover, please do not lock the screws of the bed slats at the outermost edge to avoid damaging.

**Remarque:** Assurez-vous Les lattes du lit fermer du rail latéral avant de verrouiller les vis pour éviter la casse. Cette étape est requise pour tous les deux côtés gauche et droit. De plus, ne verrouillez pas les vis des lattes de lit sur le bord le plus extérieur pour éviter d'endommager.

### STEP 9:

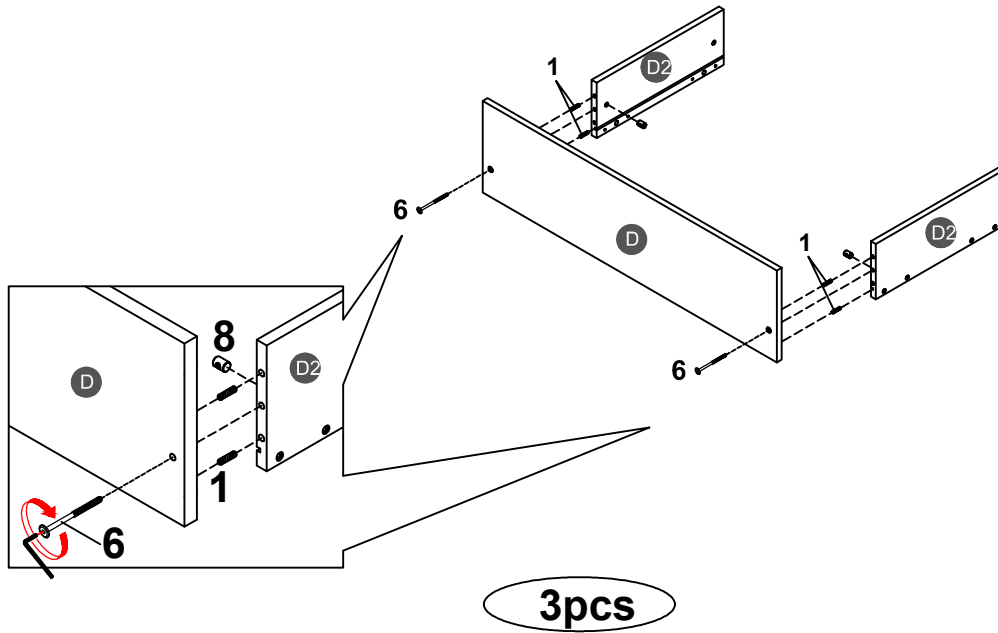

ÉTAPE

<b>1</b>		<b>6</b>		<b>8</b>	
	<b>12PCS</b>		<b>6PCS</b>		<b>6PCS</b>



### STEP 10:

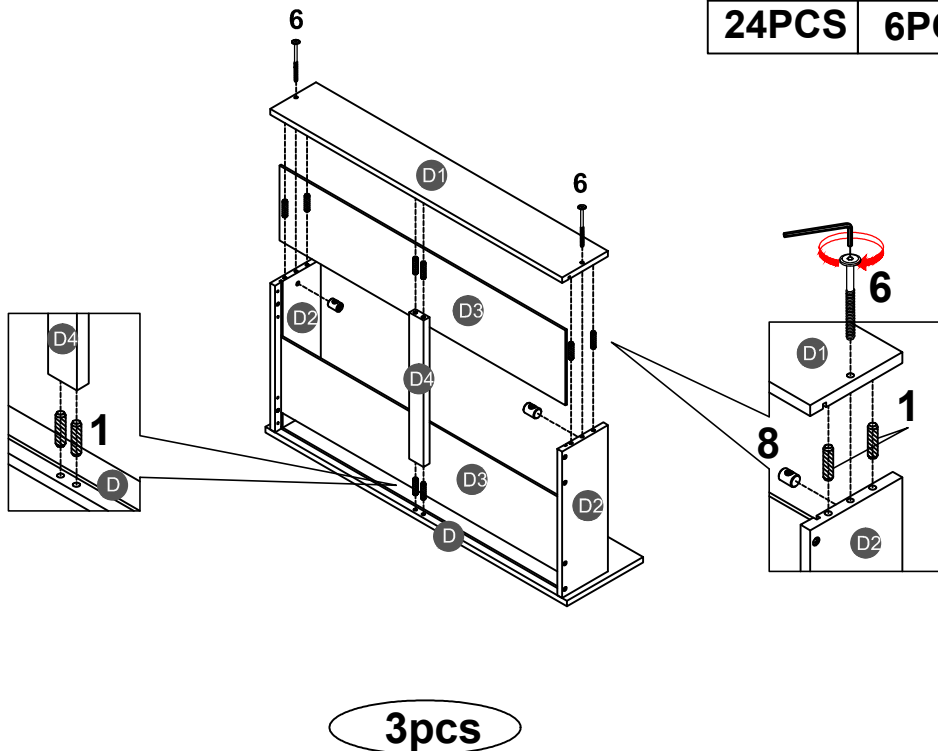

ÉTAPE

<b>1</b>		<b>6</b>		<b>8</b>	
	<b>24PCS</b>		<b>6PCS</b>		<b>6PCS</b>



## STEP 11:

ÉTAPE

<b>3</b>		<b>11</b>		<b>13</b>	
<b>12PCS</b>		<b>12PCS</b>		<b>24PCS</b>	

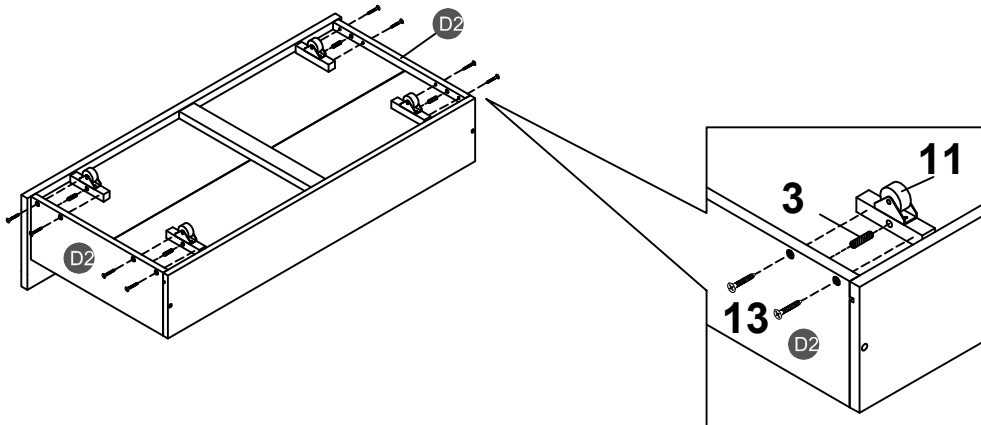

3pcs

## STEP 12:

ÉTAPE

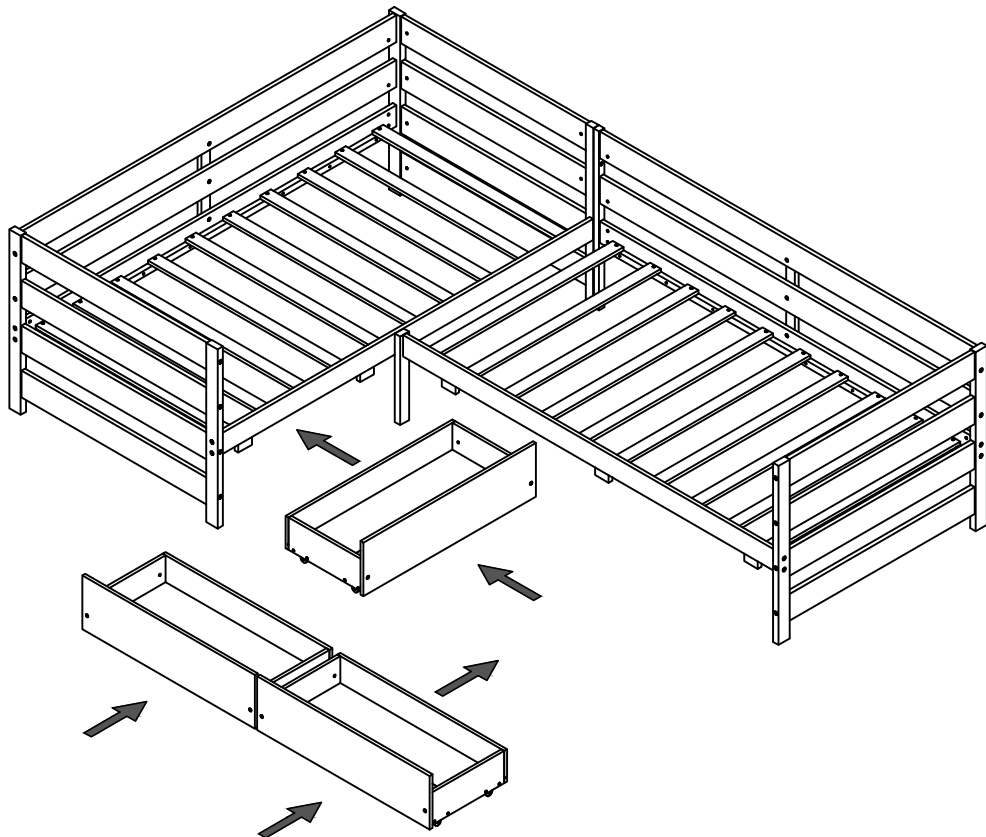

Push drawer under the bottom of the bed.  
Poussez le tiroir sous le bas du lit.

**STEP 13:**

ÉTAPE

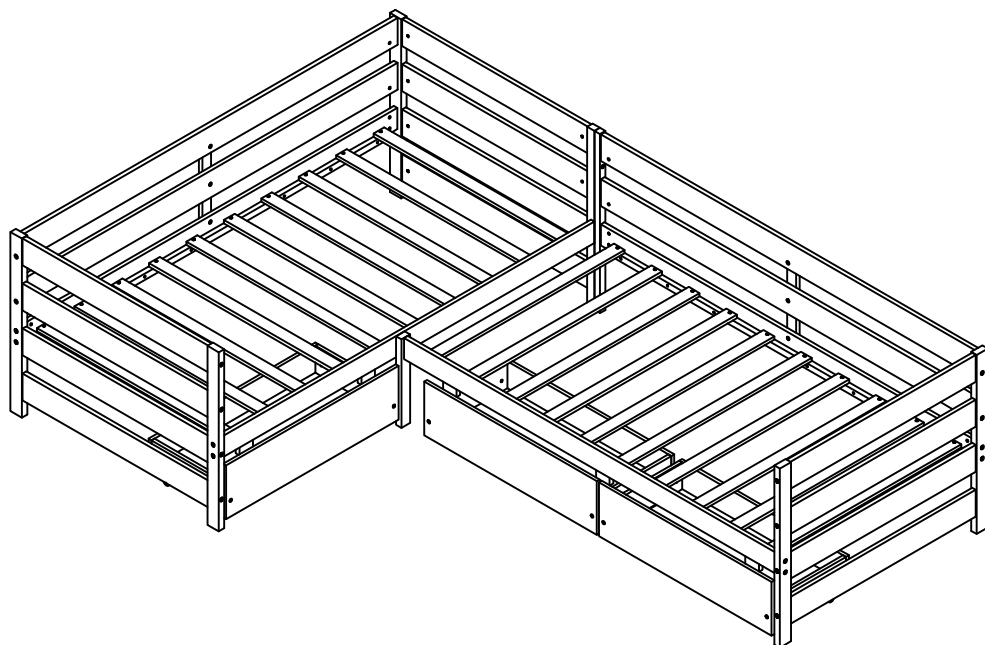

**Make sure to tighten all the screws of the bed.**

Assurez-vous de serrer toutes les vis des de lit.