

Assembly Instructions

ASHFORD ROUND BUTTERFLY TABLE

HARDWARE PART:













							
Hex Nut 12 pcs	Lock Washer (Large) 12 pcs	Flat Washer (Large) 12 pcs	Wrench 1 pc	JCBC Bolt 10 pcs	Lock Washer (Small) 10 pcs	Flat Washer (Small) 10 pcs	Allen Key 1 pc

TABLE PARTS:

				
Table Top 1pc	Pedestal Leg 4pcs	Pedestal stand 1pc	Side Panel 2pcs	Mounting plate 1pc

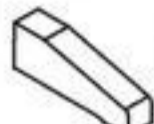
NOTE: THE UNIT SHOULD BE ASSEMBLED BY 2 OR MORE PEOPLE.

STEP 1

Turn the pedestal upside down. Attach legs by inserting hanger bolts through pre-drilled holes on pedestal. Put a **Flat Washers (Large)**, **Lock Washers (Large)** and **Hex Nut** onto the hanger bolts then tighten with the provided **Wrench**.

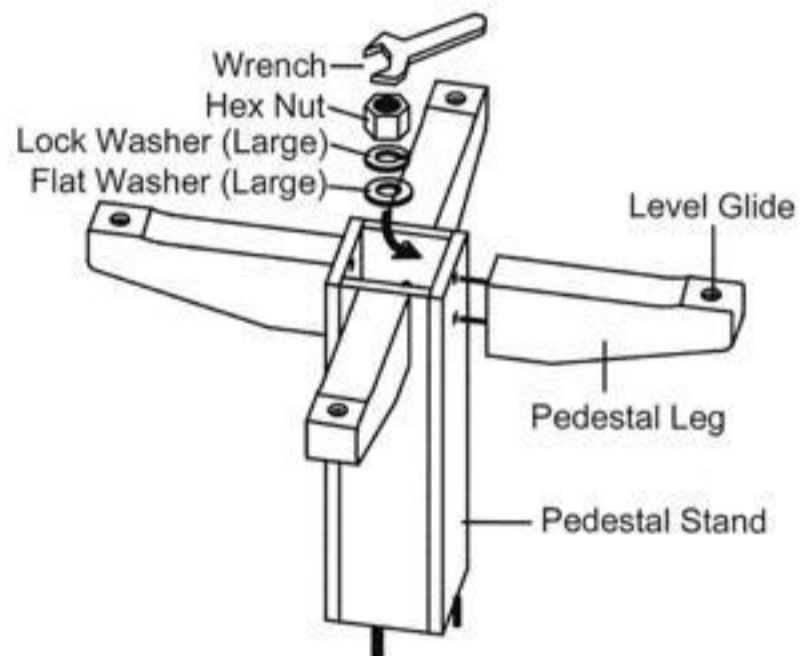

STEP 2

Position the table top upside down on a smooth, protective surface such as carpet. **Remove and discard the temporary Wood Strip.** Install the side panel and secure with **Flat Washers (Small)**, **Lock Washers (Small)** and **JCBC Bolt**. Attach Mounting Plate as shown. Secure with **Flat Washers (Small)**, **Lock Washers (Small)** and **JCBC Bolt**, then tighten all **JCBC Bolts** with **Allen Key** provided.

