

Installation Instruction

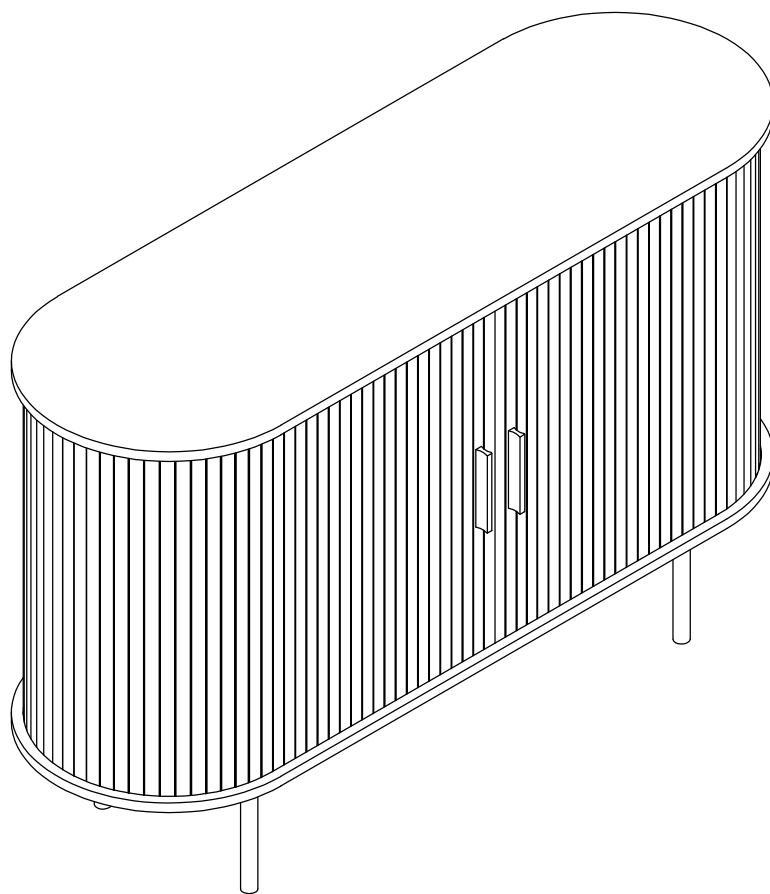

Assembling

Estimated time for assembly



35:00

What you need

- Use the packaging carton as a working surface to prevent product damage during assembly
- Phillips head screwdriver

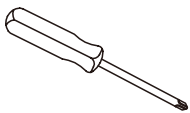

Weight Limitation



66

lbs table top

30

lbs per shelf



2 PERSONS

What's included

Code	Description	Qty
A	Cam Bolt M6X35MM	8
B	Cam Lock 15X10MM	8
C	Wooden Dowel M6X30MM	16
D	Screw M4X35MM	14
E	Bolt M4X12MM	4
F	Handle	2
G	Screw M4X14MM	18
H	Nylon Strap	2
I	Screw M3.5X14MM	8
J	Plastic Corner Support	8
K	Anchor M6X30MM	2

The Hardwares

(A)

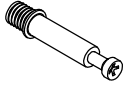

(B)



(C)



(D)

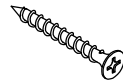

(E)



(F)

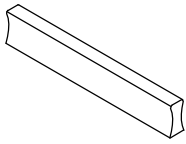

(G)



(H)

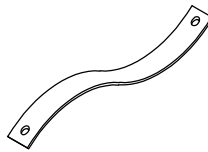

(I)



(J)



(K)

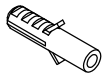

IMPORTANT:

1. Do not tighten bolts / screws completely until all bolts / screws are lined up and inserted into holes.
2. Do not over tighten screws and bolts to avoid stripping.
3. Please use hand tools to assemble this product. Do not use power tools.
4. Must need 2 people to assemble this product.



2 PERSONS

Included Accessories

Code	Description	Qty
1	Cabinet Top	1
2	Left Side Panel	1
3	Right Side Panel	1
4	Division Panel	2
5	Shelf	1
6	Back Panel	1
7	Leg	4
8	Bottom Panel	1
9	Door	2

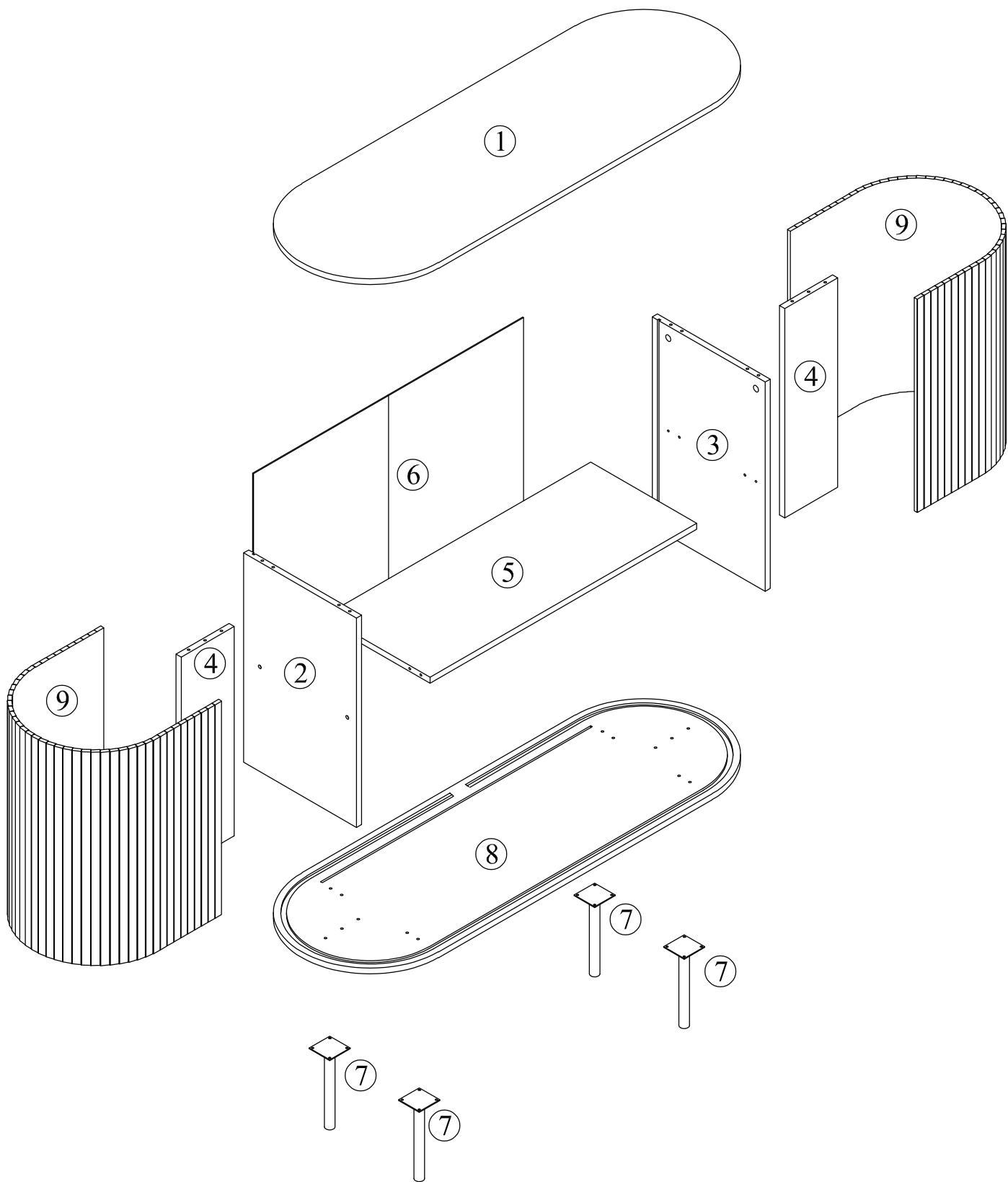

STEP 1

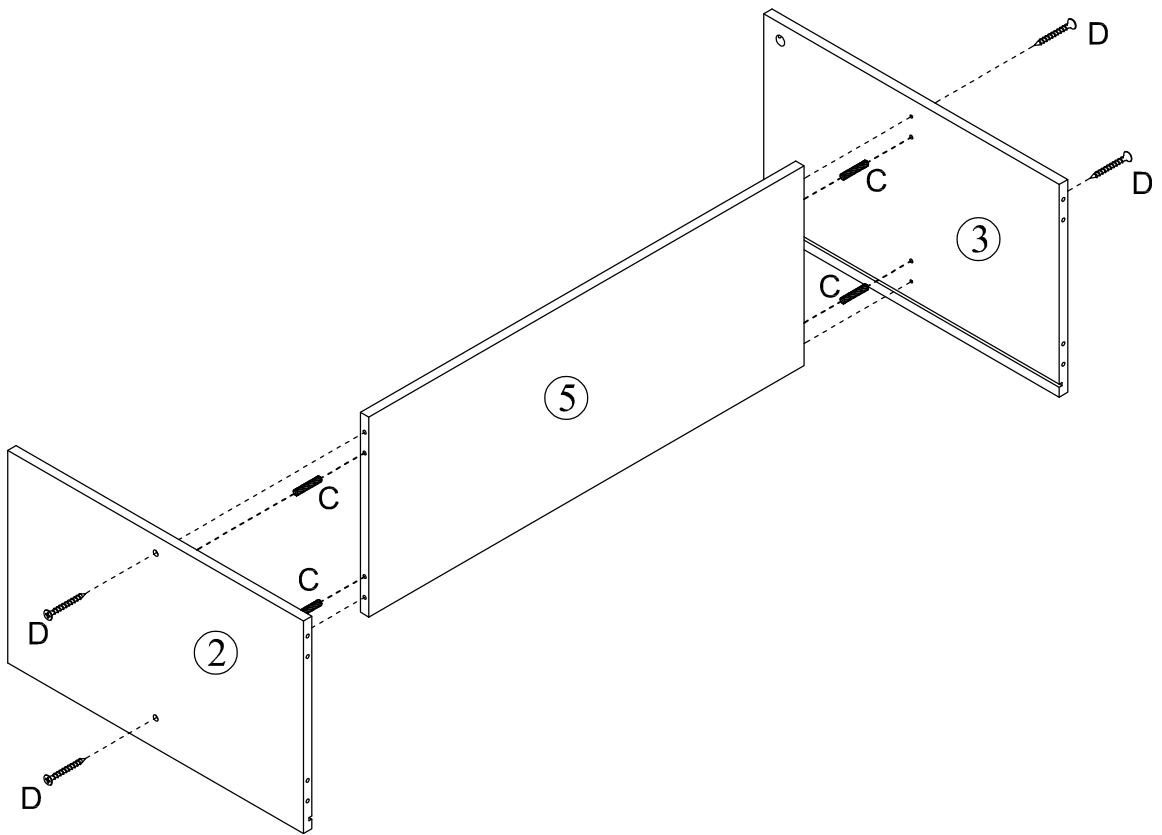
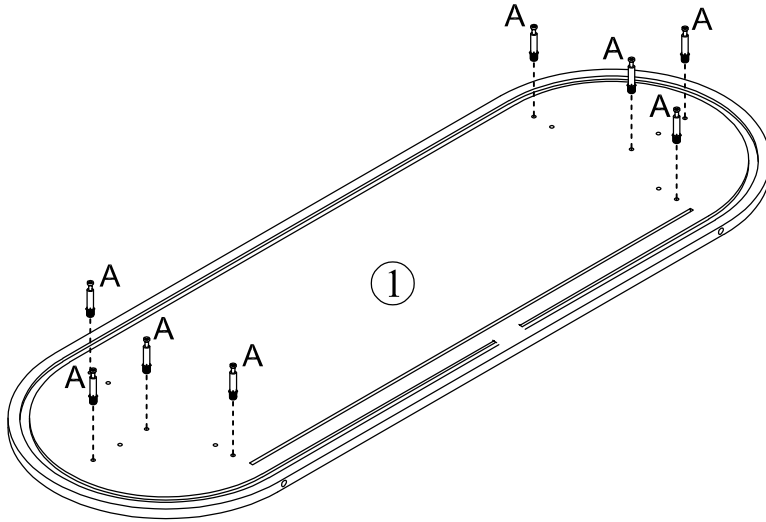
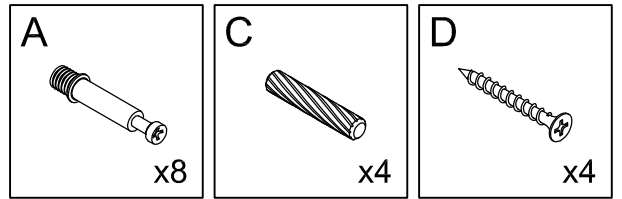

STEP 2

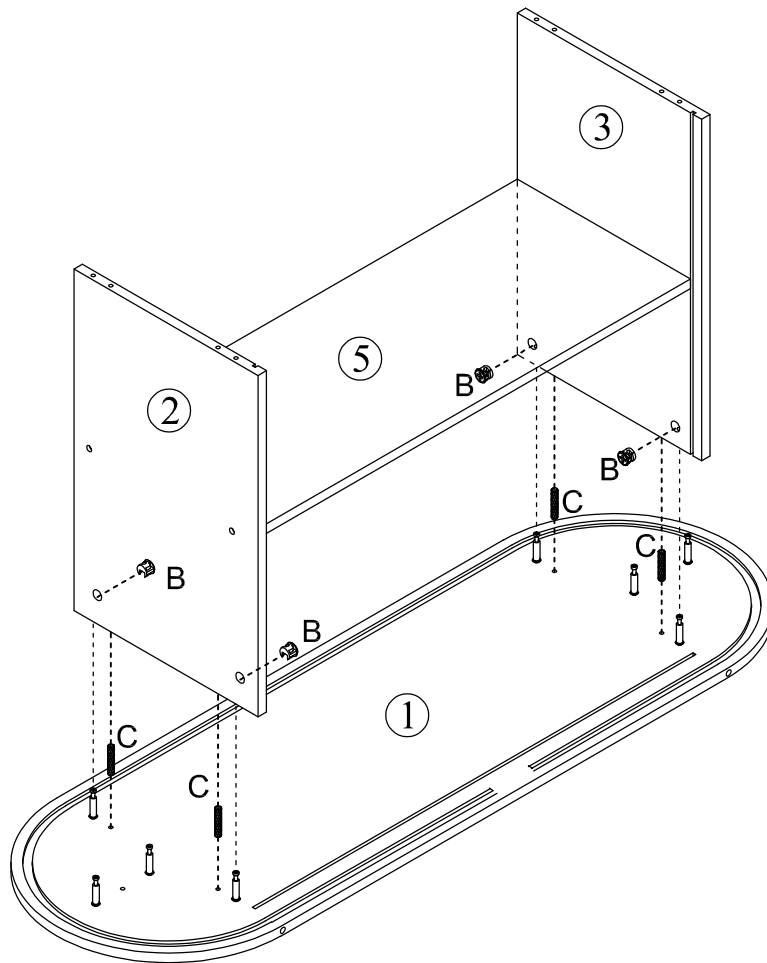
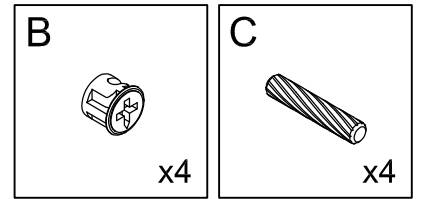

STEP 3

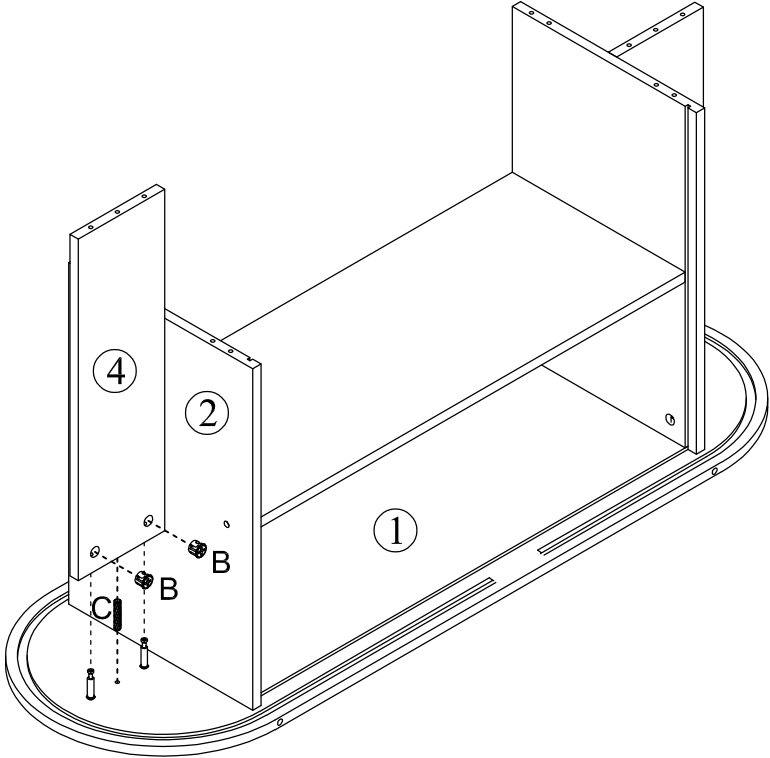
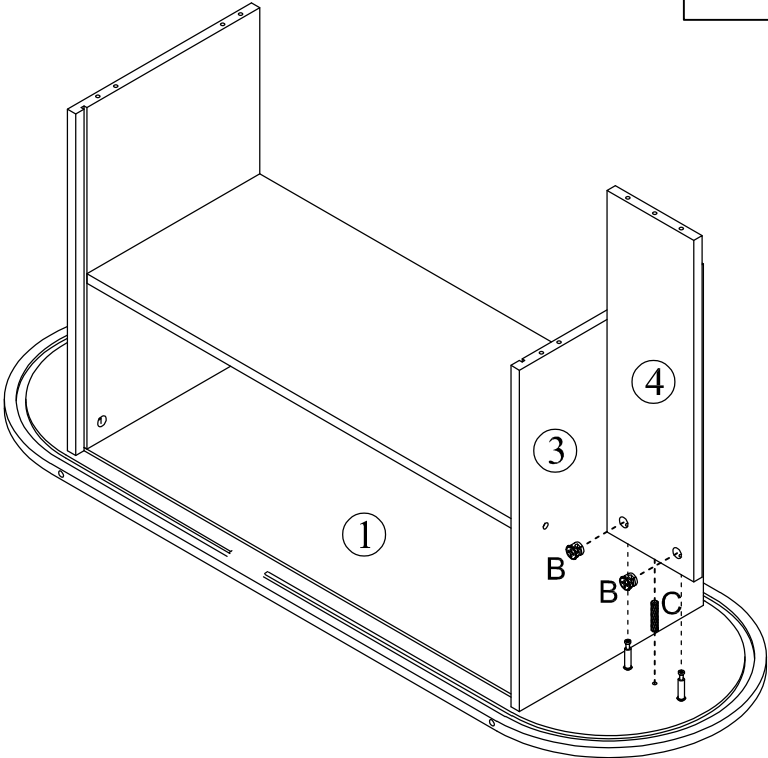
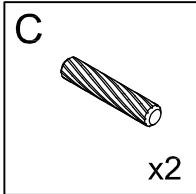
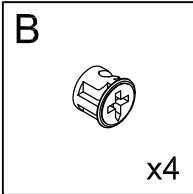

STEP 4

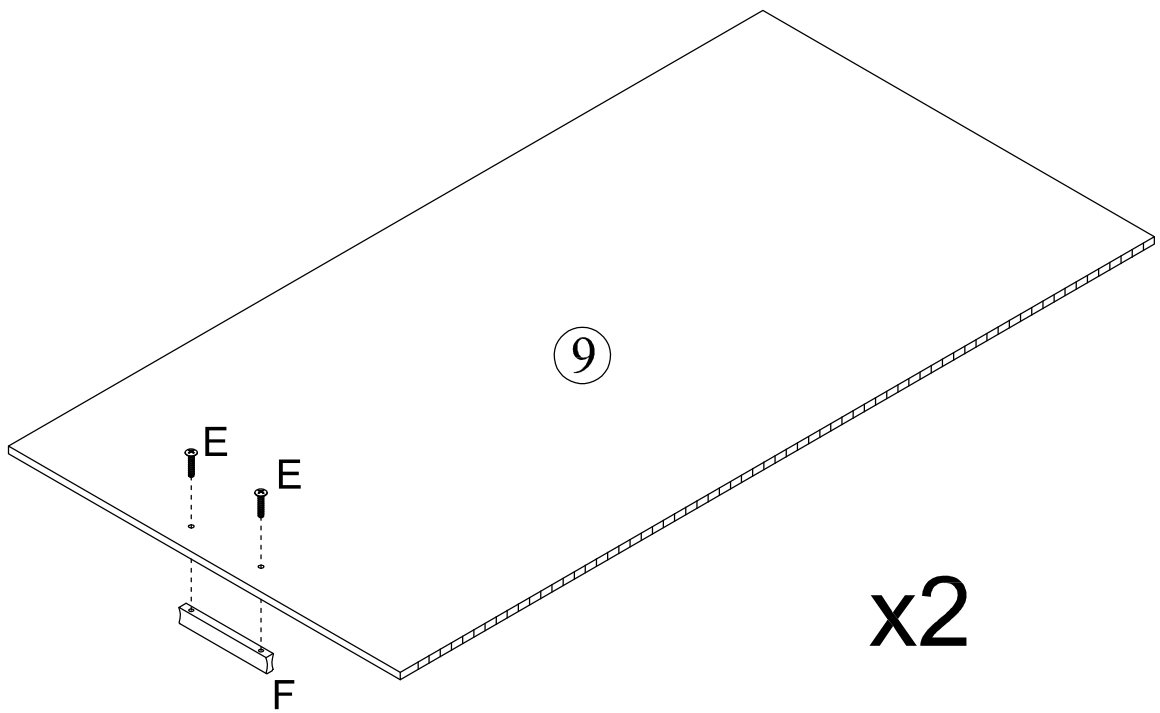
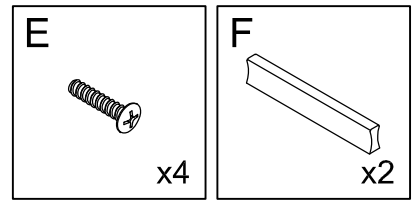

STEP 5

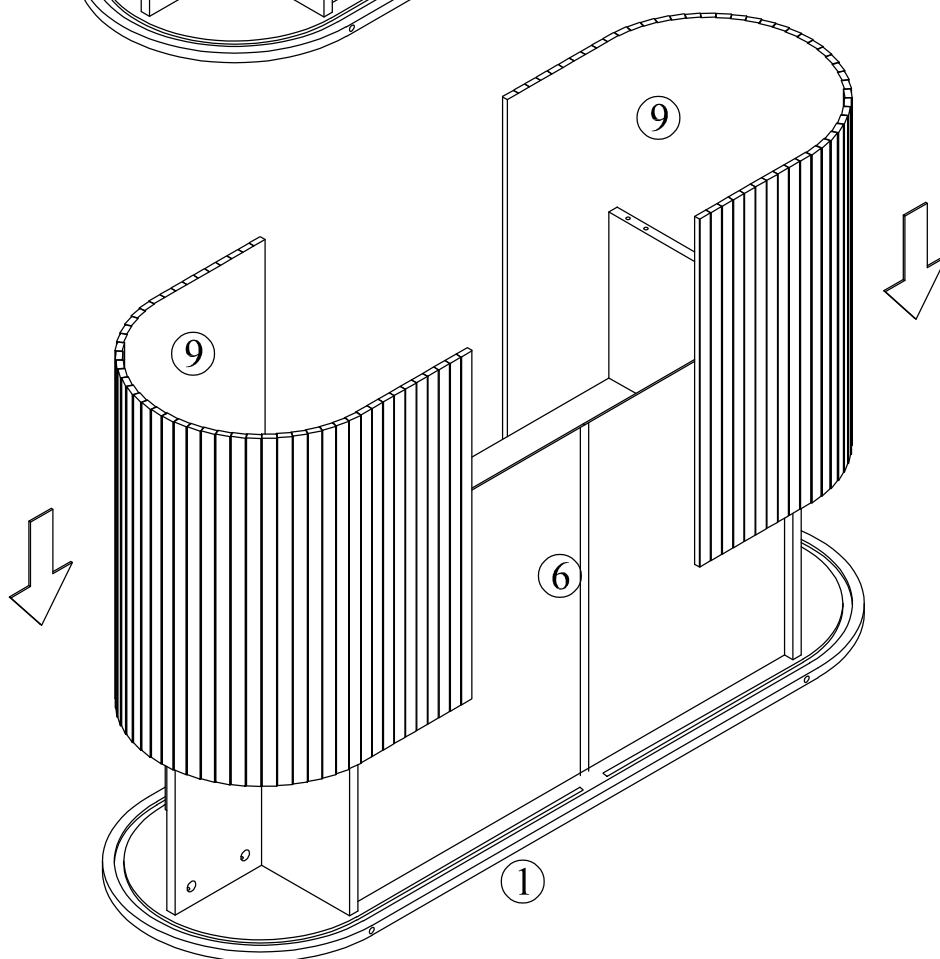
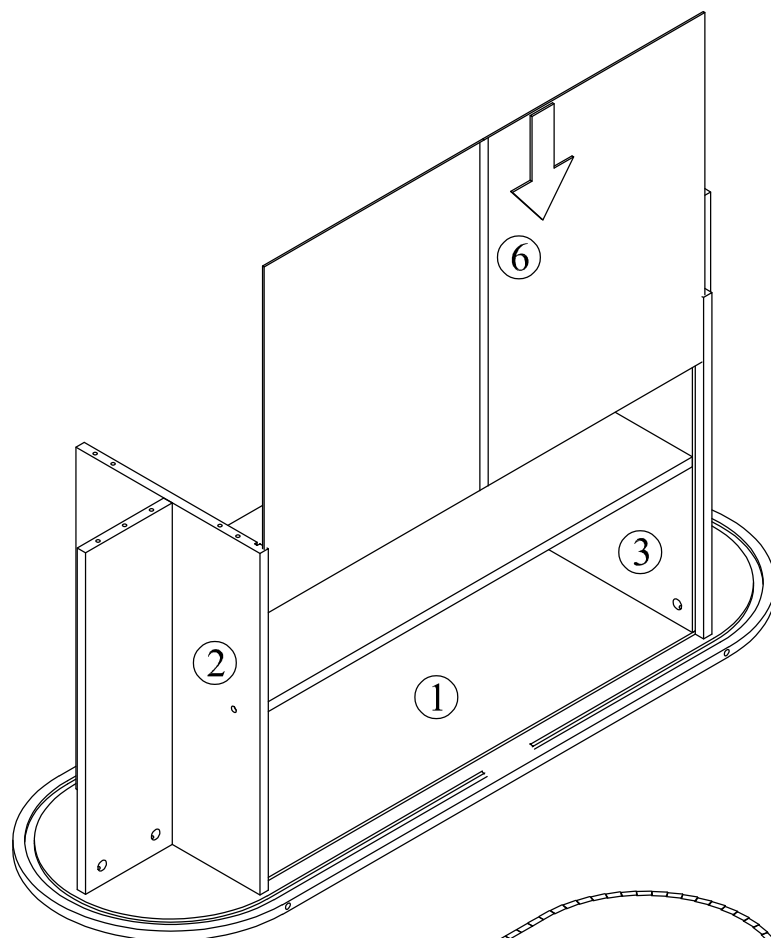

STEP 6

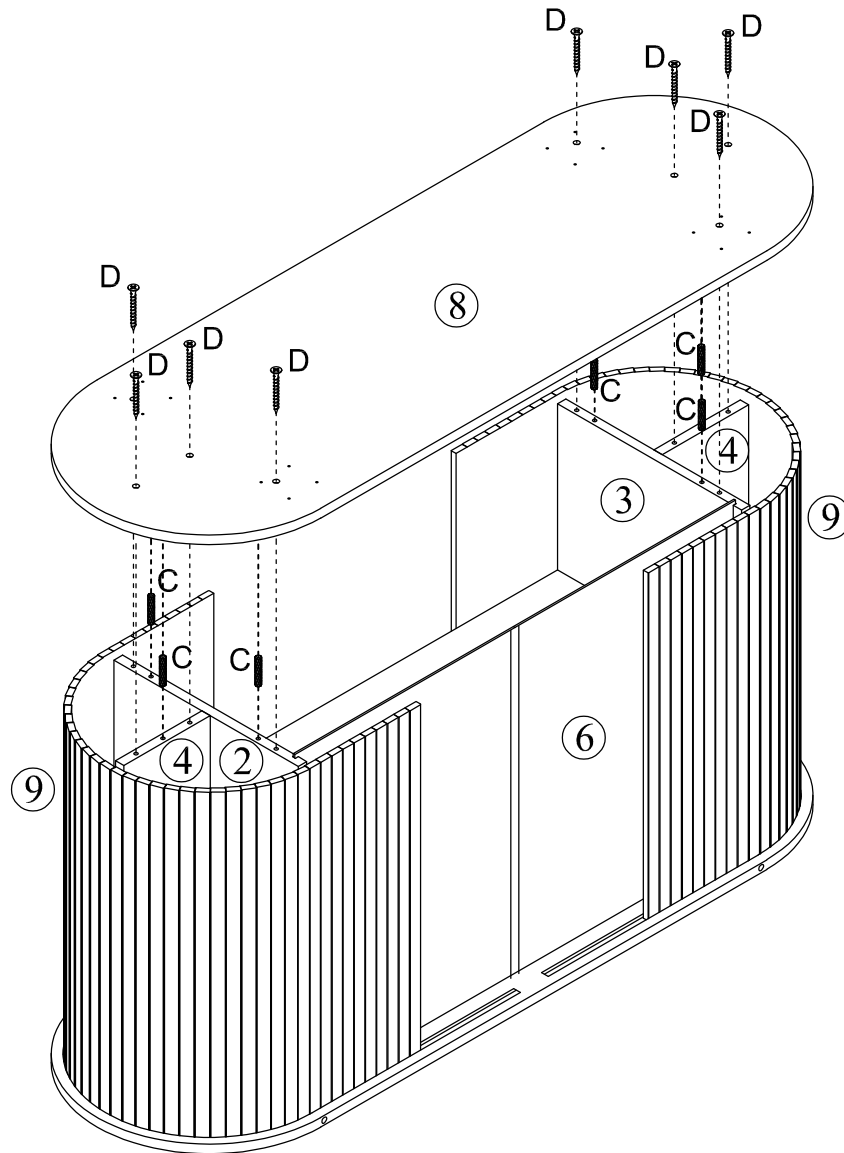
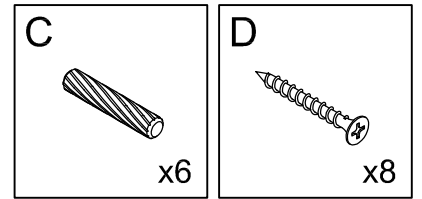

STEP 7

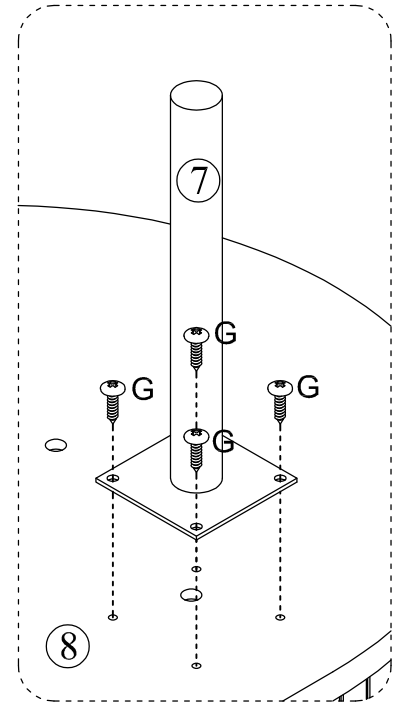
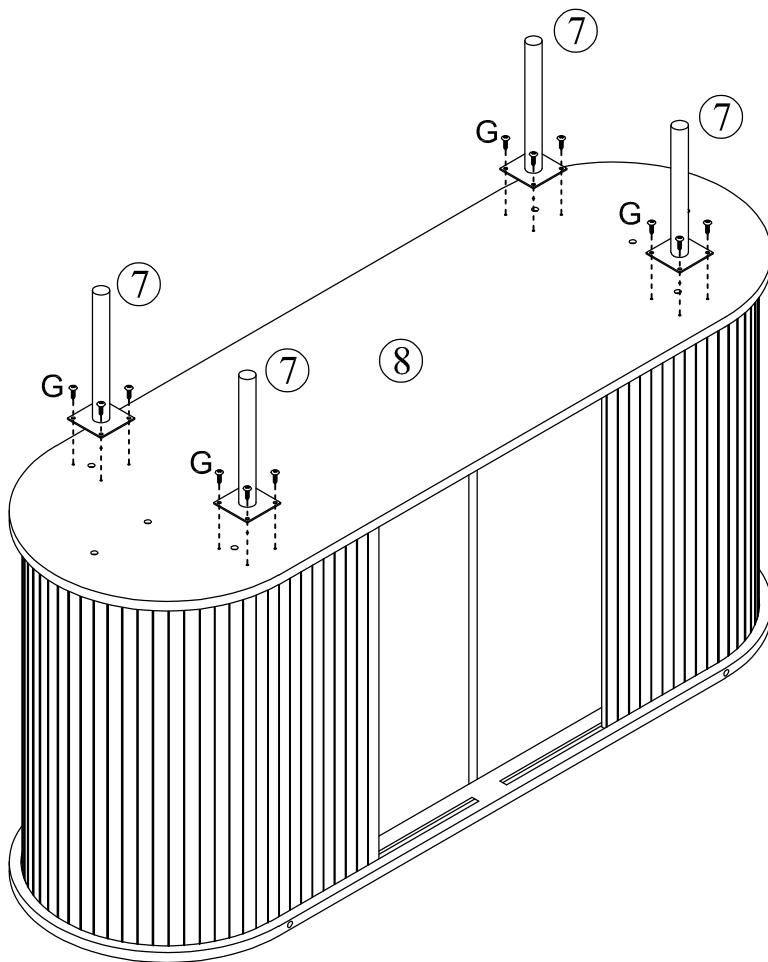
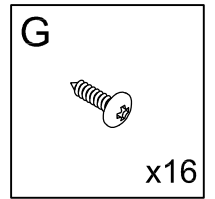

STEP 8

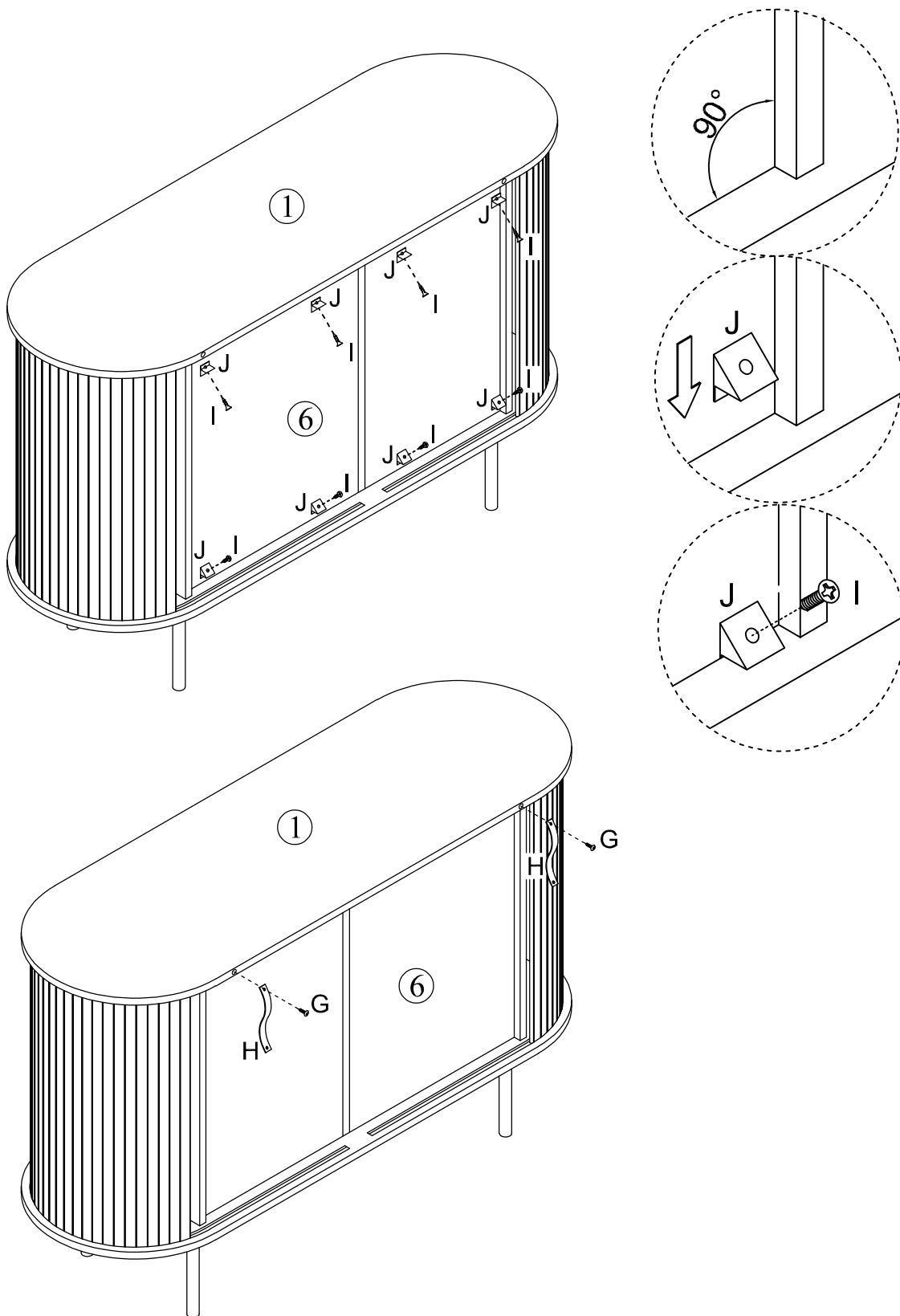
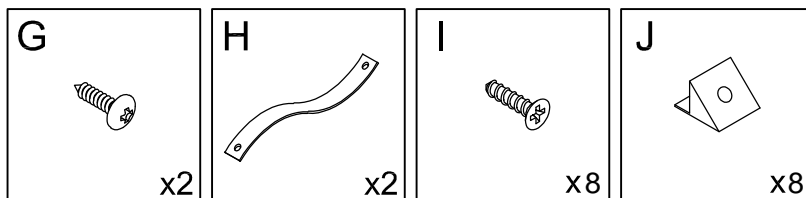

STEP 9

