

Ceiling Lights

[Instruction Manual]

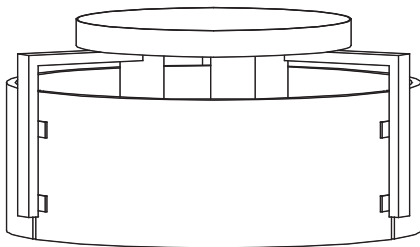

Please pay attention to the warning signs
Read the instructions with caution before operating
and keep it properly

Warning:

Risk of fire. Min 167°F/75°C supply conductors. Consult a qualified electrician to ensure correct installation. Before installation, please turn off the main power of the circuit breaker to prevent possible electric shock.

Installation Instructions

FIG.1. Turn the wall switch to the "OFF" position. Depending on which type of fuse box in your home:

FIG.2. Either turn the main (Master) switch to the "OFF" position to cut off the power supply of the entire home, or turn off the individual switch that supplies power to where the fixture will be installed.

OR

FIG.3. Either turn the main (Master) switch to the "OFF" position to cut off the power supply of the entire home, or unscrew the fuse that supplies power to where the fuse will be installed.

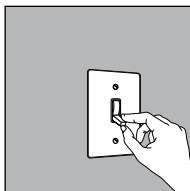

FIG.1 WALL SWITCH

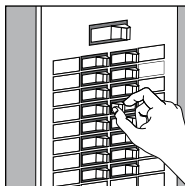

FIG.2 BREAKER PANEL

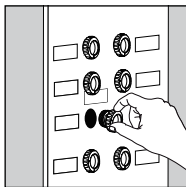
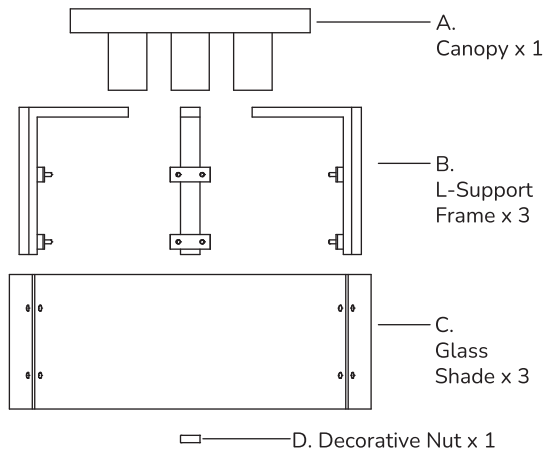









FIG.3 FUSE BOX

PACKING LIST



1. Decorative Nut (D) have been pre-installed on Canopy (A).

INSTALLATION KIT

AA	x1	BB	x2	CC	x1	DD	x3
							
Mounting Bracket		Outlet Box Screw		Ground Screw		Wire Nut	
EE	x6	FF	x24	GG	x12		x1
							
Pipe Frame Screw		Silicon Washer		Knurled Nut		Screwdriver	

1. Silicon Washer (FF) have some extra pieces for back-up.

2. Ground Screw (CC) have been pre-installed on Mounting Bracket (AA).

INSTALLATION

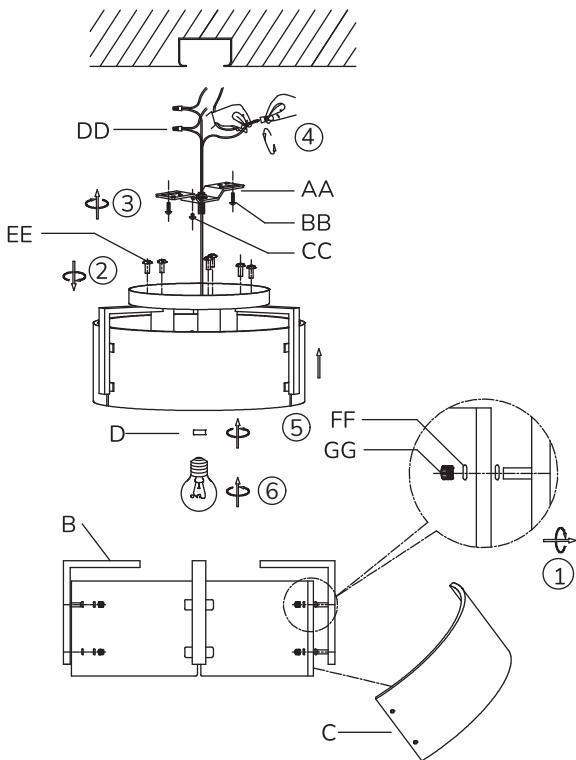

Step 1:

Add Silicon Washer (FF) on both sides of the glass hole as shown in the figure, then pass the Knurled Nut (GG) through and fix the Glass Shade (C) and the L-Support Frame (B) together. (Loosen the Knurled Nut (GG) appropriately)

Step 2:

1. Use Pipe Frame Screw (EE) to lock the Canopy (A) and the L-Support

Frame (B) together.

Step 3:

1. Loosen the Decorative Nut (D) from Canopy (A), take out the Mounting Bracket (AA).
2. Take off the screws from the outlet box, and secure the Mounting Bracket (AA) onto the box with the screws taken off or Outlet Box Screw (BB).

Step 4:

1. Wrap the ground wire from the outlet box around the Ground Screw (CC) on the Mounting Bracket (AA), and then connect the ground wire from the fixture to the ground wire from the outlet box.
2. Connect the wires from the fixture to the house supply wires, neutral wire (white) to neutral wire, and hot wire (black) to hot wire.
3. Spread apart the wires so that the hot wires are on one side of the outlet box and the neutral wires are on the other side.

Step 5:

Fix Canopy (A) to Mounting Bracket (AA) using Decorative Nut (D).

Step 6:

E26 Bulbs X 3

(Max 60W each, not included)

Specifications

- Input Voltage: 120VAC 60Hz
- Max. Load Power: incandescent Bulb 60W
- Socket Type: Standard Medium E26

One Year Limited Warranty

Supported by our professional team, we provide One Year Warranty for materials and workmanship from the purchase date. Please note that the warranty does not cover damage caused by personal misuse or improper installation.

Please attach your Order ID and Name so that our dedicated customer service team can help you better.



Made in China