

INSTRUCTION MANUAL



Cast Aluminum Dining Armchair

INTRODUCTION

Thanks for purchasing and trusting with your home decorating plans.

This product is a piece of furniture designed







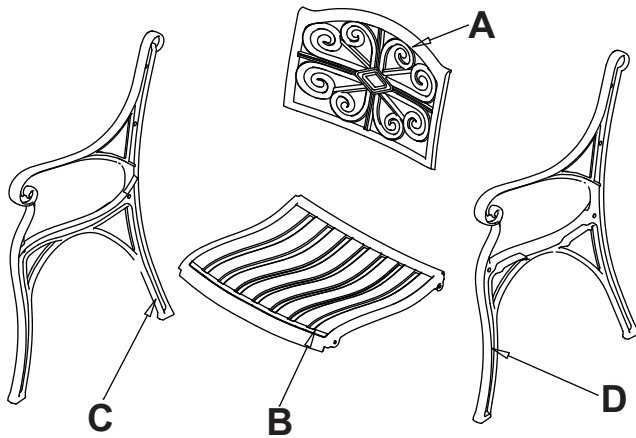
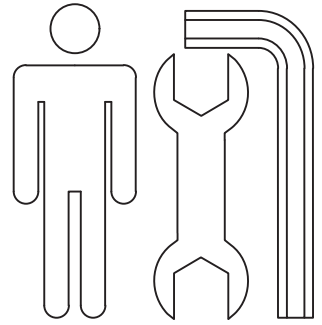



We are committed to R&D and innovation and creating the most exquisite and diverse outdoor series.

After unpacking and before every use, check whether the item shows any damage. In addition, check that you have all parts and hardware before assembly. If there is any damage, please do not use it and call customer service or email us. If you do not have all the parts lists, have your dealer contact us and we will send them to you immediately.

This item of furniture is intended for indoor and outdoor use. Please take time to read and follow the instructions below. Then, use this item as described in this operating manual. We accept no liability for damage caused by improper use.



Note: The 2 armrests (C&D) are universal.

| Part Number | Images and Sizes | Qty. |
|-------------|----------------------------------------------------------------------------------------------|------|
| A |  | 1 |
| B |  | 1 |
| C |  | 1 |
| D |  | 1 |
| E |  M8*25 | 4 |
| F |  M8*15 | 4 |
| I |  M8 | 4 |
| J |  M8 | 4 |
| G |  M8*16 | 4 |
| H |  M8*12 | 4 |

ASSEMBLY INSTRUCTIONS

CAVEAT

Note: Please only tighten any bolts once all bolts are placed correctly and the product is lying flat. If you tighten one bolt, it may cause other bolts to get out of position.

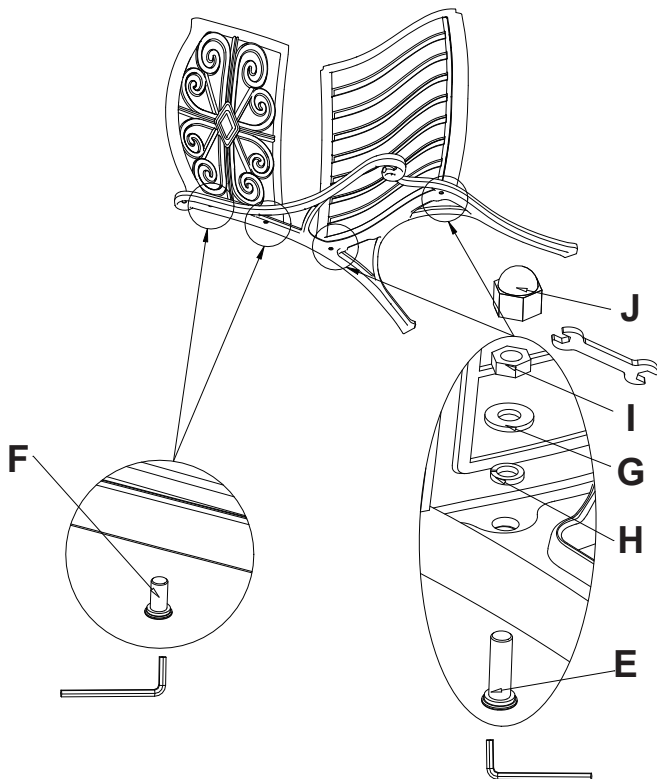

STEP 1

Attach the back frame (A) to the armrest (C/D) with 2 bolts (F).

Attach the back frame (A) to the seat frame (B) with 2 bolts (E), 2 spring washers (H), 2 washers (G) and 2 nuts (I). Do not over-tighten them.

ASSEMBLY INSTRUCTIONS

CAVEAT

Note: Please only tighten any bolts once all bolts place correctly and the product is lying flat. If you tighten one bolt, it may cause other bolts to get out of position.

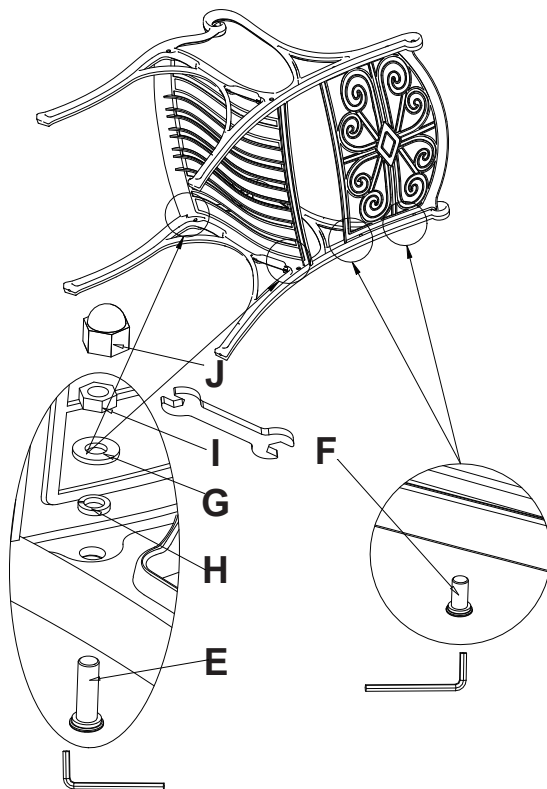

STEP 2

Attach the back frame (A) to the armrest (C/D) using 2 bolts (F).

Fasten the back frame (A) to the seat frame (B) with 2 bolts (E), 2 spring washers (H), 2 washers (G) and 2 nuts (I). Do not over-tighten them.

Upon completing the entire assembly and bolting up, you can tighten all the screws and put on the protective caps (J).

CARE AND MAINTENANCE

Follow the instructions for the product's material to ensure it stays in the best shape as long as possible. The information below is a general guideline.

Don't hesitate to get in touch with us to learn more.

- Only rinse it thoroughly with clean water to wash away dirt and grime. Never use abrasive cleansers on the furniture since they can attack the surface and leave behind scratch marks.
- For stubborn grime and stains, use a soft sponge and mild soapy water. Then dry it with a cloth or paper towel.
- Check the stability of the screws, nuts, and nut caps before each use. Then, tighten them up after one to two months' use whenever required.
- Avoid improper use, and be careful not to scratch or damage the surface with sharp objects.
- When you move your furniture, lift it rather than pulling or pushing it to avoid damaging the floor, legs, and mounting.