

Repair, replacement of parts and components of the goods during the warranty period are made at the following address:

Mebelix GmbH
Mörsenbroicher Weg 191, 40470 Düsseldorf, Germany

sales@mebelix.de

Distributor in the UK:

Shefa Trading Limited, 167-169 Great Portland Street, London, W1W 5PF, United Kingdom,

sales@shefa-trading.co.uk

Schreibtisch Shefa Line Nano Computer desk Shefa Line Nano

(DE) Montageanleitung:

(EN) Assembly instructions:

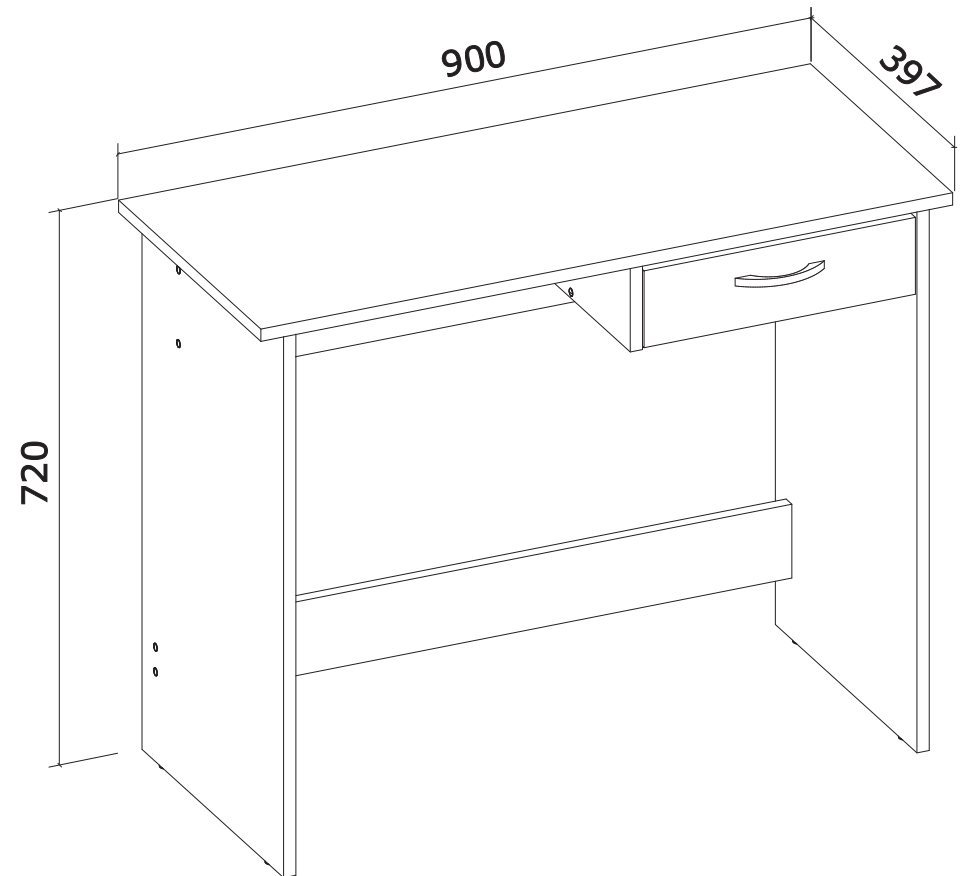

<p>IT ATTENZIONE</p> <p>Se il mobile si ribalta può causare lesioni di compressione serio e fatali. Per prevenire il rischio che il mobile si ribalti, questo ultimo deve essere fissato permanentemente alla parete.</p> <p>Si accessor per il fissaggio alla parete non sono inclusi perché parte di materiali diversi (cemento, gesso, mattoni, ecc.) richiedono l'uso di accessori adatti allo parete della sua casa. Per maggiori dettagli, rivolgersi a un rivenditore specializzato.</p>	<p>GB WARNING</p> <p>Important information Read carefully. Keep this information for further reference.</p> <p>DE ACHTUNG</p> <p>Wichtigste Information Doch lesen! Dieses Informations anbewahren</p> <p>FR ATTENTION</p> <p>Information importante Attention! Conservé ces informations pour un usage ultérieur.</p> <p>PL UWAGA</p> <p>Ważne informacje Przejdź uważnie Zachowaj informacje przyszłość.</p> <p>CZ VAROVÁNÍ</p> <p>Upozornění Učteně přečteť Uchovávejte si informace pro případ potřeby.</p> <p>SK UPOZORNENIE</p> <p>Upozornenie Informácie si uchovajte pre prípad potreby.</p>	<p>IT ATTENZIONE</p> <p>Se il mobile si ribalta può causare lesioni di compressione serio e fatali. Per prevenire il rischio che il mobile si ribalti, questo ultimo deve essere fissato permanentemente alla parete.</p> <p>Si accessor per il fissaggio alla parete non sono inclusi perché parte di materiali diversi (cemento, gesso, mattoni, ecc.) richiedono l'uso di accessori adatti allo parete della sua casa. Per maggiori dettagli, rivolgersi a un rivenditore specializzato.</p>	<p>FR ATTENTION</p> <p>Risque de blessure grave en cas de chute du meuble. Pour éviter que le meuble ne bascule, il faut le fixer au mur de façon permanente.</p> <p>Les fixations ne sont pas incluses car leur choix dépend du matériau du mur sur lequel est fixé le meuble. Utilisez les fixations adaptées au matériau du mur. Pour obtenir des conseils sur un revendeur spécialisé.</p>	<p>PT IMPORTANTE</p> <p>Importante! Le esta instrução cuidadosamente. Guarde como referência.</p> <p>UA УВАГА</p> <p>Важливі інформація Прочитайте уважно Збережіть як посилання</p>	<p>DK ADVARSEL</p> <p>Vigtige oplysninger! Læs omhyggeligt. Gem disse oplysninger til senere brug.</p>
<p>IT ATTENZIONE</p> <p>Se il mobile si ribalta può causare lesioni di compressione serio e fatali. Per prevenire il rischio che il mobile si ribalti, questo ultimo deve essere fissato permanentemente alla parete.</p> <p>Si accessor per il fissaggio alla parete non sono inclusi perché parte di materiali diversi (cemento, gesso, mattoni, ecc.) richiedono l'uso di accessori adatti allo parete della sua casa. Per maggiori dettagli, rivolgersi a un rivenditore specializzato.</p>	<p>GB WARNING</p> <p>Important information Read carefully. Keep this information for further reference.</p> <p>DE ACHTUNG</p> <p>Wichtigste Information Doch lesen! Dieses Informations anbewahren</p> <p>FR ATTENTION</p> <p>Information importante Attention! Conservé ces informations pour un usage ultérieur.</p> <p>PL UWAGA</p> <p>Ważne informacje Przejdź uważnie Zachowaj informacje przyszłość.</p> <p>CZ VAROVÁNÍ</p> <p>Upozornění Učteně přečteť Uchovávejte si informace pro případ potřeby.</p> <p>SK UPOZORNENIE</p> <p>Upozornenie Informácie si uchovajte pre prípad potreby.</p>	<p>FR ATTENTION</p> <p>Risque de blessure grave en cas de chute du meuble. Pour éviter que le meuble ne bascule, il faut le fixer au mur de façon permanente.</p> <p>Les fixations ne sont pas incluses car leur choix dépend du matériau du mur sur lequel est fixé le meuble. Utilisez les fixations adaptées au matériau du mur. Pour obtenir des conseils sur un revendeur spécialisé.</p>	<p>PT IMPORTANTE</p> <p>Importante! Le esta instrução cuidadosamente. Guarde como referência.</p> <p>UA УВАГА</p> <p>Важливі інформація Прочитайте уважно Збережіть як посилання</p>	<p>DK ADVARSEL</p> <p>Vigtige oplysninger! Læs omhyggeligt. Gem disse oplysninger til senere brug.</p>	<p>DK ADVARSEL</p> <p>Vigtige oplysninger! Læs omhyggeligt. Gem disse oplysninger til senere brug.</p>

<p>IT ATTENZIONE</p> <p>Se il mobile si ribalta può causare lesioni di compressione serio e fatali. Per prevenire il rischio che il mobile si ribalti, questo ultimo deve essere fissato permanentemente alla parete.</p> <p>Si accessor per il fissaggio alla parete non sono inclusi perché parte di materiali diversi (cemento, gesso, mattoni, ecc.) richiedono l'uso di accessori adatti allo parete della sua casa. Per maggiori dettagli, rivolgersi a un rivenditore specializzato.</p>	<p>GB WARNING</p> <p>Important information Read carefully. Keep this information for further reference.</p> <p>DE ACHTUNG</p> <p>Wichtigste Information Doch lesen! Dieses Informations anbewahren</p> <p>FR ATTENTION</p> <p>Information importante Attention! Conservé ces informations pour un usage ultérieur.</p> <p>PL UWAGA</p> <p>Ważne informacje Przejdź uważnie Zachowaj informacje przyszłość.</p> <p>CZ VAROVÁNÍ</p> <p>Upozornění Učteně přečteť Uchovávejte si informace pro případ potřeby.</p> <p>SK UPOZORNENIE</p> <p>Upozornenie Informácie si uchovajte pre prípad potreby.</p>	<p>FR ATTENTION</p> <p>Risque de blessure grave en cas de chute du meuble. Pour éviter que le meuble ne bascule, il faut le fixer au mur de façon permanente.</p> <p>Les fixations ne sont pas incluses car leur choix dépend du matériau du mur sur lequel est fixé le meuble. Utilisez les fixations adaptées au matériau du mur. Pour obtenir des conseils sur un revendeur spécialisé.</p>	<p>PT IMPORTANTE</p> <p>Importante! Le esta instrução cuidadosamente. Guarde como referência.</p> <p>UA УВАГА</p> <p>Важливі інформація Прочитайте уважно Збережіть як посилання</p>	<p>DK ADVARSEL</p> <p>Vigtige oplysninger! Læs omhyggeligt. Gem disse oplysninger til senere brug.</p>	<p>DK ADVARSEL</p> <p>Vigtige oplysninger! Læs omhyggeligt. Gem disse oplysninger til senere brug.</p>
<p>IT ATTENZIONE</p> <p>Se il mobile si ribalta può causare lesioni di compressione serio e fatali. Per prevenire il rischio che il mobile si ribalti, questo ultimo deve essere fissato permanentemente alla parete.</p> <p>Si accessor per il fissaggio alla parete non sono inclusi perché parte di materiali diversi (cemento, gesso, mattoni, ecc.) richiedono l'uso di accessori adatti allo parete della sua casa. Per maggiori dettagli, rivolgersi a un rivenditore specializzato.</p>	<p>GB WARNING</p> <p>Important information Read carefully. Keep this information for further reference.</p> <p>DE ACHTUNG</p> <p>Wichtigste Information Doch lesen! Dieses Informations anbewahren</p> <p>FR ATTENTION</p> <p>Information importante Attention! Conservé ces informations pour un usage ultérieur.</p> <p>PL UWAGA</p> <p>Ważne informacje Przejdź uważnie Zachowaj informacje przyszłość.</p> <p>CZ VAROVÁNÍ</p> <p>Upozornění Učteně přečteť Uchovávejte si informace pro případ potřeby.</p> <p>SK UPOZORNENIE</p> <p>Upozornenie Informácie si uchovajte pre prípad potreby.</p>	<p>FR ATTENTION</p> <p>Risque de blessure grave en cas de chute du meuble. Pour éviter que le meuble ne bascule, il faut le fixer au mur de façon permanente.</p> <p>Les fixations ne sont pas incluses car leur choix dépend du matériau du mur sur lequel est fixé le meuble. Utilisez les fixations adaptées au matériau du mur. Pour obtenir des conseils sur un revendeur spécialisé.</p>	<p>PT IMPORTANTE</p> <p>Importante! Le esta instrução cuidadosamente. Guarde como referência.</p> <p>UA УВАГА</p> <p>Важливі інформація Прочитайте уважно Збережіть як посилання</p>	<p>DK ADVARSEL</p> <p>Vigtige oplysninger! Læs omhyggeligt. Gem disse oplysninger til senere brug.</p>	<p>DK ADVARSEL</p> <p>Vigtige oplysninger! Læs omhyggeligt. Gem disse oplysninger til senere brug.</p>



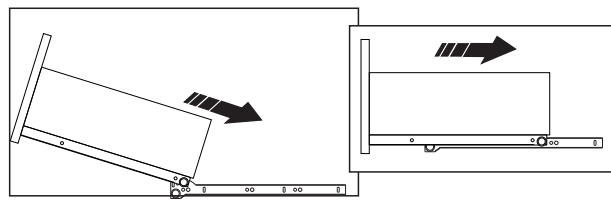
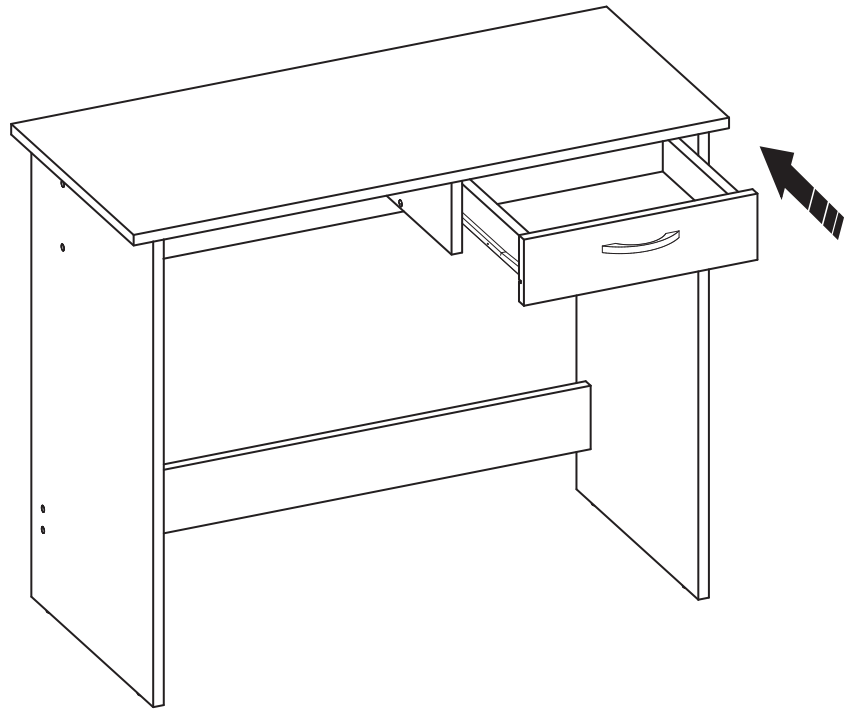













<p>IT ATTENZIONE</p> <p>Se il mobile si ribalta può causare lesioni di compressione serio e fatali. Per prevenire il rischio che il mobile si ribalti, questo ultimo deve essere fissato permanentemente alla parete.</p> <p>Si accessor per il fissaggio alla parete non sono inclusi perché parte di materiali diversi (cemento, gesso, mattoni, ecc.) richiedono l'uso di accessori adatti allo parete della sua casa. Per maggiori dettagli, rivolgersi a un rivenditore specializzato.</p>	<p>GB WARNING</p> <p>Important information Read carefully. Keep this information for further reference.</p> <p>DE ACHTUNG</p> <p>Wichtigste Information Doch lesen! Dieses Informations anbewahren</p> <p>FR ATTENTION</p> <p>Information importante Attention! Conservé ces informations pour un usage ultérieur.</p> <p>PL UWAGA</p> <p>Ważne informacje Przejdź uważnie Zachowaj informacje przyszłość.</p> <p>CZ VAROVÁNÍ</p> <p>Upozornění Učteně přečteť Uchovávejte si informace pro případ potřeby.</p> <p>SK UPOZORNENIE</p> <p>Upozornenie Informácie si uchovajte pre prípad potreby.</p>	<p>FR ATTENTION</p> <p>Risque de blessure grave en cas de chute du meuble. Pour éviter que le meuble ne bascule, il faut le fixer au mur de façon permanente.</p> <p>Les fixations ne sont pas incluses car leur choix dépend du matériau du mur sur lequel est fixé le meuble. Utilisez les fixations adaptées au matériau du mur. Pour obtenir des conseils sur un revendeur spécialisé.</p>	<p>PT IMPORTANTE</p> <p>Importante! Le esta instrução cuidadosamente. Guarde como referência.</p> <p>UA УВАГА</p> <p>Важливі інформація Прочитайте уважно Збережіть як посилання</p>	<p>DK ADVARSEL</p> <p>Vigtige oplysninger! Læs omhyggeligt. Gem disse oplysninger til senere brug.</p>	<p>DK ADVARSEL</p> <p>Vigtige oplysninger! Læs omhyggeligt. Gem disse oplysninger til senere brug.</p>
<p>IT ATTENZIONE</p> <p>Se il mobile si ribalta può causare lesioni di compressione serio e fatali. Per prevenire il rischio che il mobile si ribalti, questo ultimo deve essere fissato permanentemente alla parete.</p> <p>Si accessor per il fissaggio alla parete non sono inclusi perché parte di materiali diversi (cemento, gesso, mattoni, ecc.) richiedono l'uso di accessori adatti allo parete della sua casa. Per maggiori dettagli, rivolgersi a un rivenditore specializzato.</p>	<p>GB WARNING</p> <p>Important information Read carefully. Keep this information for further reference.</p> <p>DE ACHTUNG</p> <p>Wichtigste Information Doch lesen! Dieses Informations anbewahren</p> <p>FR ATTENTION</p> <p>Information importante Attention! Conservé ces informations pour un usage ultérieur.</p> <p>PL UWAGA</p> <p>Ważne informacje Przejdź uważnie Zachowaj informacje przyszłość.</p> <p>CZ VAROVÁNÍ</p> <p>Upozornění Učteně přečteť Uchovávejte si informace pro případ potřeby.</p> <p>SK UPOZORNENIE</p> <p>Upozornenie Informácie si uchovajte pre prípad potreby.</p>	<p>FR ATTENTION</p> <p>Risque de blessure grave en cas de chute du meuble. Pour éviter que le meuble ne bascule, il faut le fixer au mur de façon permanente.</p> <p>Les fixations ne sont pas incluses car leur choix dépend du matériau du mur sur lequel est fixé le meuble. Utilisez les fixations adaptées au matériau du mur. Pour obtenir des conseils sur un revendeur spécialisé.</p>	<p>PT IMPORTANTE</p> <p>Importante! Le esta instrução cuidadosamente. Guarde como referência.</p> <p>UA УВАГА</p> <p>Важливі інформація Прочитайте уважно Збережіть як посилання</p>	<p>DK ADVARSEL</p> <p>Vigtige oplysninger! Læs omhyggeligt. Gem disse oplysninger til senere brug.</p>	<p>DK ADVARSEL</p> <p>Vigtige oplysninger! Læs omhyggeligt. Gem disse oplysninger til senere brug.</p>



Schreibtisch Shefa Line Nano

Computer desk Shefa Line Nano

Nr	Paket / Package	x	a	b	c	
1	1/1	1	900	397	16	
2	1/1	1	704	395	16	
3	1/1	1	704	395	16	
4	1/1	1	808	176	16	
5	1/1	1	808	96	16	
6	1/1	1	353	100	16	
7	1/1	1	357	96	16	
8	1/1	1	109	285	16	
9	1/1	1	300	55	16	
10	1/1	1	250	55	16	
11	1/1	1	250	55	16	
12	1/1	1	330	255	3	
13	1/1	Zubehör / Furniture				

N0 x 1	 3.5x12	A1 x 13	 8x30	F1 x 4	
N1 x 18	 3.5x16	R x 1		E1 x 4	
Z x 9	 1.5x20	G1 x 13	 6.4x50	GM x 4	
W x 1		G0 x 11		O2 x 4	
W1 x 2		Sc x 2	 4x22	Y x 1	
		U1 x 5		T0 x 1	 250mm

