

## CARE AND MAINTENANCE:

- Clean regularly with normal detergent and warm water.
- Always make a habit of drying your sink after use and buffing with a soft cloth. This will ensure that no build up of lime scale or other mineral deposits can occur.
- Clean the sink once a week using a non-abrasive cleanser such as dish-soap and a clean soft sponge. Rinse off with water and wipe dry.
- Never let soap or other household cleaners to dry on the surface of the sink. Most products contain additives which will affect the finish of the sink.
- Never use bleach solutions on the sink, as it is harmful to stainless steel. If left on the sink too long it can cause surface pitting.
- Never use a steel wool pad to clean your sink. Doing so may damage the sink's surface and cause discoloration.
- The sink surface is hard and resistant to scratches, but some scratches may appear over time from normal use.
- For stubborn hard water stains, you can use a straight or 50% vinegar solution. Let the solution sit on the sink for one hour, then scrub thoroughly with a 3M scotch-brite pad and rinse well.

## RUVATI LIMITED LIFETIME WARRANTY

This product has been manufactured and inspected to the highest possible quality standards. Ruvati sinks carry a limited lifetime warranty for residential use.

Should you experience any defects in materials or workmanship within the warranty period, we will repair or replace the defective product, subject to the following conditions:

- Any claim made under this warranty must include a copy of a valid proof of purchase showing the date and place of purchase.
- Our obligation under this warranty is to the original purchaser only, and may not be transferred.
- Product replacement does not include shipping costs or labor installation costs.
- This warranty applies to residential installations only.
- Ruvati reserves the right to examine product in question and its installation prior to replacement.
- If an identical replacement product is not available, Ruvati reserves the right to replace the defective product with a similar product.

**NOTE: Accessories such as rinse grids, cutting boards, strainers are not covered by this warranty.**

This warranty relates to defects in manufacture, materials or workmanship in a Ruvati stainless steel

kitchen sink supplied for installation into domestic premises in the United States. It does not extend to :

- Damage resulting from failure to maintain the product in accordance with the Care and Maintenance instructions in this manual.
- Normal wear and tear, scratches or accidental damage.
- Faults arising from improper use and/or installation.
- Defects in accessories, strainers and rinse grids.

**All incidental or consequential damages are specifically excluded. No additional warranties, express or implied are given, including but not limited to, any implied warranty of merchantability or fitness for a particular purpose.**

Some states do not allow the exclusion or limitation of incidental or consequential damages or limitations on how long an implied warranty lasts, so the above limitations or exclusions may not apply to you. This warranty gives you specific legal rights, and you may also have other rights which vary from state to state.

# RUVATI®

## INSTALLATION GUIDE

# TOPMOUNT EPIROCK COMPOSITE SINK

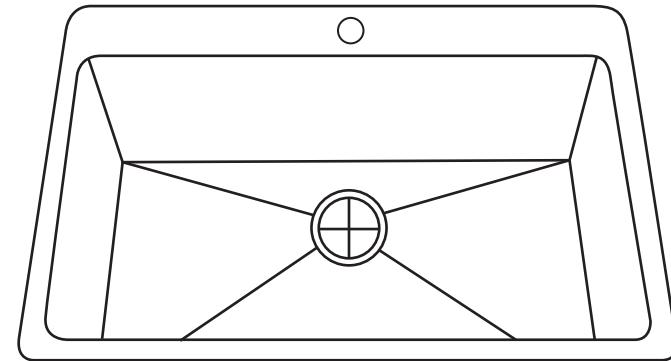

RVG1321, RVG1325, RVG1327

Register your product at: [www.ruvati.com/register](http://www.ruvati.com/register)

## RUVATI®

Address: 2705 Meister Pl, Round Rock, TX 78664

USA Phone: 1.855.478.8284

Email: [support@ruvati.com](mailto:support@ruvati.com)

## ATTENTION INSTALLER:

Please read all information below and keep this installation guide for future reference.

Keep the sink fully covered after installation to keep away dirt and construction dust, until all construction is complete and the site has been cleaned.

Ruvati recommends that this sink be installed only by a professional installer.

**Sink edges may be sharp and can cause accidental injury if not careful. Wear cut-resistant protective gloves during installation.**

Inspect the sink and box contents immediately upon delivery. If you see any shipping damages on the sink, or missing parts, contact Ruvati Support.

Templates are only provided as a guide. Place template on sink to ensure the template will give you the proper cutout for the sink. Ruvati is not responsible for improper sink or countertop installation. **Ruvati is not liable for any damages to sink or countertop or personal injury during installation.**

Follow all local plumbing and building codes.

## TOOLS REQUIRED

Caulk or Plumbers Putty  
Drill with Depth Stop  
Sink Mounting Clips  
Putty Knife

Phillips Head Screwdriver  
Jigsaw or Keyhole Saw  
Wrench  
Tape Measure

## TOPMOUNT INSTALLATION

1. Place the sink cut-out template on the countertop, where the sink is to be installed. Trace around the outside perimeter with a pencil (Figure 1). **Note: Make sure you are using the top-mount template.**

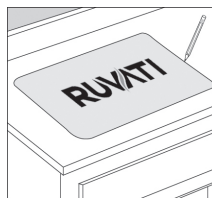

Figure 1

2. After tracing, remove the template. Use a straight edge if necessary to straighten out the traced outline. Use a drill with a 7/8" spade bit to drill four pilot holes, one in each corner inside the outline. These holes will be your starting points for sawing the hole, so they must be large enough to fit the blade of a jig saw or keyhole saw.
3. Disassemble mounting clips by removing these screws and metal clips from the anchor.
4. Attach mounting clips to the sink body by pushing them into the slots on the sink (Figure 3).
5. Before installing the sink, place a bead of plumbers putty along the edge of the drain opening inside the sink and press the strainer body in place. Turn the sink upside down and tighten the strainer locknut with a wrench. While tightening, hold the strainer steady with pliers to keep it from turning. Wipe away any excess plumber's putty.
6. Fit the gasket on the sink drain pipe (tailpiece) and attach it to the strainer bottom with a slip nut. Tighten this nut by hand. For most threaded connections, apply a sealant such as plumbers putty, silicone tape or "pipe dope" to the threads to ensure a watertight connection.
7. Attach the drain pipe assembly that comes with your sink.
8. Apply a "rope of plumbers putty or caulk around the perimeter of the underside of the sink. Flip the sink over and carefully place it into the countertop opening, with all of the drains and attachments secured. Press down firmly to seat the sink against the countertop (Figure 4).
9. Position the bottom of the mounting clip so that it is gripping the countertop. Use a screwdriver to tighten the screw until the mounting clip is snug against the countertop (Figure 5).
10. After the sink is positioned and securely in place, place the plumbers putty around the underside of the faucet body or its mounting plate and install it into the sink (Figure 6).
11. Attach all plumbing connections to the house drain line and water supply tubing. Apply a bead of silicone caulking around the perimeter of the sink where it meets the counter to seal any gaps. Fill the sink with water and leave it overnight to add weight and help it settle in place. Afterward, retighten the sink clips if necessary.

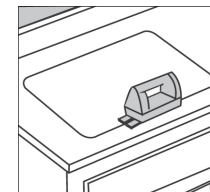

Figure 2

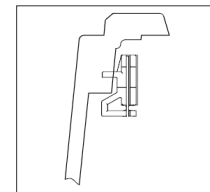

Figure 3

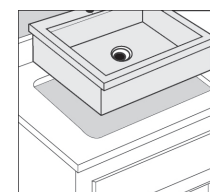

Figure 4

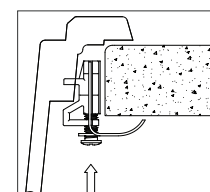

Figure 5

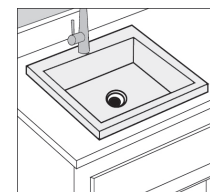

Figure 6