

ASSEMBLY INSTRUCTION

SKU CODE: N708P387817/N708P387818/N708P387819

INSTRUCTIONS DE MONTAGE

SKU NUMBER: N708P387817/N708P387818/N708P387819

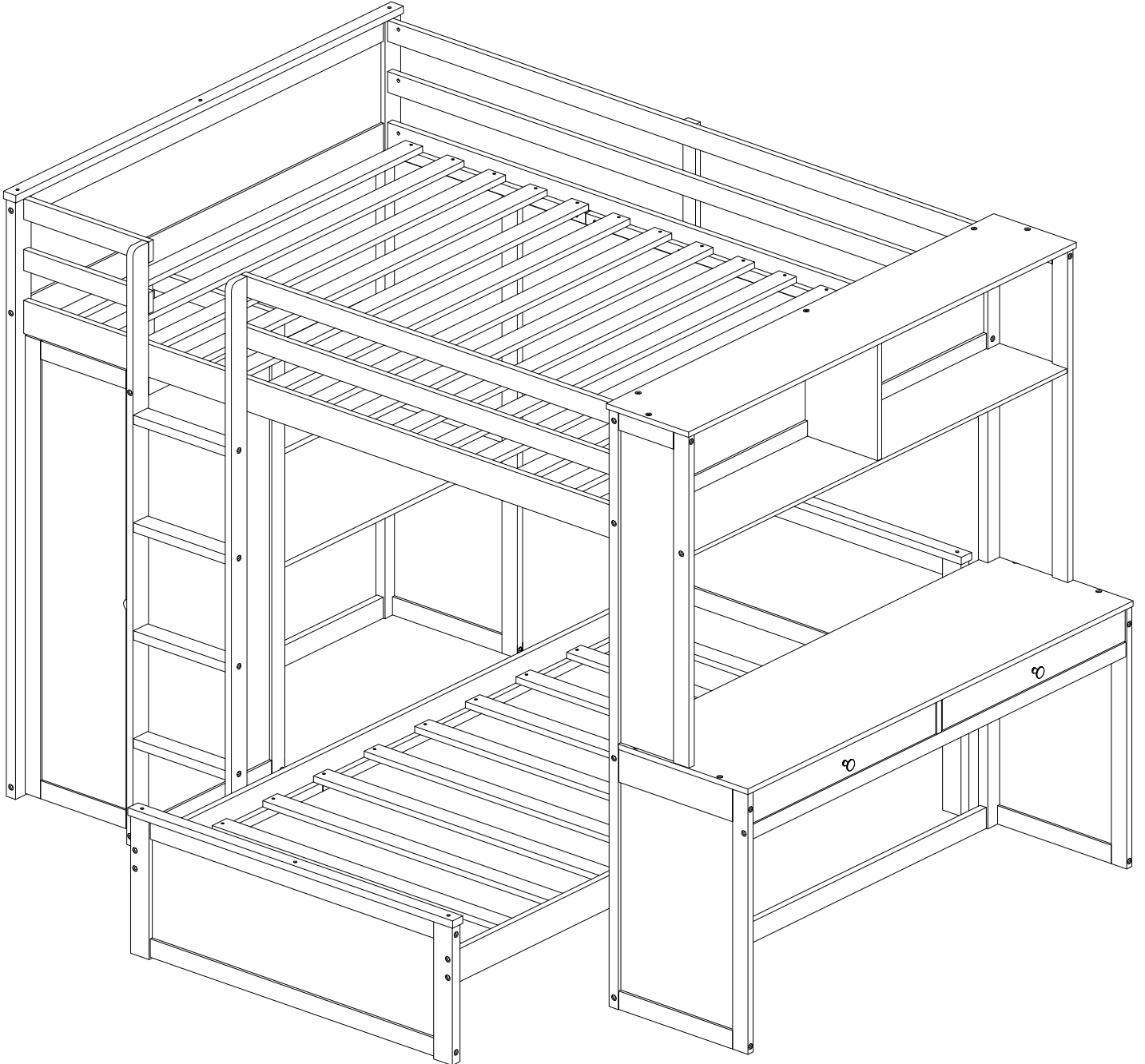

! SAFETY WARNINGS !

1. This bed is designed for use only mattress (es) meeting the following specifications on the upper bunk, and lower bunk

Upper bed

Bed Type	Length	Width	Thickness
<i>Twin Standard</i>	<i>74" - 75"</i>	<i>37 1/2" - 38 1/2"</i>	<i>6" max</i>

Lower bed

Bed Type	Length	Width	Thickness
<i>Twin Standard</i>	<i>74" - 75"</i>	<i>37 1/2" - 38 1/2"</i>	<i>6" max</i>

2. Replacement parts, including additional guardrails, maybe obtained from any of our (GIGACLOUD TECHNOLOGY (USA) INC. 4388 SHIRLEY AVE, EL MONTE, CA 91731) dealers
3. Follow the information on the warnings appearing on the upper bunk bed end structure and on the carton. Do not remove warning label from bed
4. Always use the recommended size mattresses or mattress supports, or both, to help prevent the likelihood of entrapment or falls.
5. Surface of mattress must be at least 5" (127mm) below the upper edge of guardrails
6. Do not allow children under 6 years of age to use the upper bunk.
7. Periodically check and ensure that the guardrail, ladder, and other components are in their proper position, free from damage, and that all connectors are tight.
8. Do not allow horseplay on or under the bed and prohibit jumping on the bed.
9. Always use the ladder for entering and leaving the upper bunk.
10. Do not use substitute part. Contact the manufacture or dealer for replacement part
11. Use of a night light may provide added safety precaution for a child using the upper bunk..
12. Always use guardrails on both long sides of the upper bunk. If the bunk bed will be placed next to the wall, the guardrail that runs the full length of the bed should be placed against the wall to prevent entrapment between the bed and wall.
13. The use of water or sleep flotation mattresses is prohibited
14. STRANGULATION HAZARD - Never attach or hang items to any part of the bunk bed that are not designed for use with the bed; for example, but not limited to, hook, belts and jump ropes
15. Keep these instruction for future reference
16. Prohibit more than one person on upper bunk
17. We recommend assembling your bunk bed on the shipping carton to protect your floor or carpet
18. Be certain all staples are out of the box before beginning assembly on the shipping carton.

! AVERTISSEMENTS DE SÉCURITÉ !

1. Ce lit est conçu pour utiliser uniquement des matelas répondant aux spécifications suivantes sur le lit supérieur, et couchette inférieure

Lit supérieur

Type de lit	Longueur	Largeur	Épaisseur
Twin Standard	74" - 75"	37 ¹ / ₂ " - 38 ¹ / ₂ "	6" max

Lit inférieur

Type de lit	Longueur	Largeur	Épaisseur
Twin Standard	74" - 75"	37 ¹ / ₂ " - 38 ¹ / ₂ "	6" max

2. Les pièces de rechange, y compris les garde-corps supplémentaires, peuvent être obtenues auprès de l'un de nos revendeurs (GIGACLOUD TECHNOLOGY (USA) INC. 4388 SHIRLEY AVE, EL MONTE, CA 91731).
3. Suivez les informations sur les avertissements apparaissant sur la structure d'extrémité supérieure du lit superposé et sur le carton. Ne retirez pas l'étiquette d'avertissement du lit
4. Utilisez toujours des matelas ou des supports de matelas de taille recommandée, ou les deux, pour éviter tout risque de coincement ou de chute.
5. La surface du matelas doit être à au moins 5" (127 mm) sous le bord supérieur des garde-corps.
6. Ne laissez pas les enfants de moins de 6 ans utiliser le lit supérieur.
7. Vérifiez et assurez-vous périodiquement que le garde-corps, l'échelle et les autres composants sont dans leur position correcte, exempts de dommages et que tous les connecteurs sont bien serrés.
8. Ne permettez pas les chahuts sur ou sous le lit et interdisez de sauter sur le lit.
9. Utilisez toujours l'échelle pour entrer et sortir du lit supérieur.
10. N'utilisez pas de pièce de rechange. Contactez le fabricant ou le revendeur pour une pièce de rechange
11. L'utilisation d'une veilleuse peut fournir une mesure de sécurité supplémentaire pour un enfant utilisant le lit supérieur.
12. Utilisez toujours des garde-corps sur les deux côtés longs du lit supérieur. Si le lit superposé doit être placé à côté du mur, le garde-corps qui s'étend sur toute la longueur du lit doit être placé contre le mur pour éviter tout coincement entre le lit et le mur.
13. L'utilisation de matelas flottants à eau ou de sommeil est interdite
14. **RISQUE D'ÉTRANGULATION** - N'attachez ou ne suspendez jamais d'objets à une partie du lit superposé qui ne sont pas conçus pour être utilisés avec le lit ; par exemple, mais sans s'y limiter, des crochets, des ceintures et des cordes à sauter
15. Conservez ces instructions pour référence future
16. Interdire plus d'une personne sur la couchette supérieure
17. Nous vous recommandons d'assembler votre lit superposé sur le carton d'expédition pour protéger votre sol ou votre tapis.
18. Assurez-vous que toutes les agrafes sont sorties de la boîte avant de commencer l'assemblage sur le carton d'expédition.



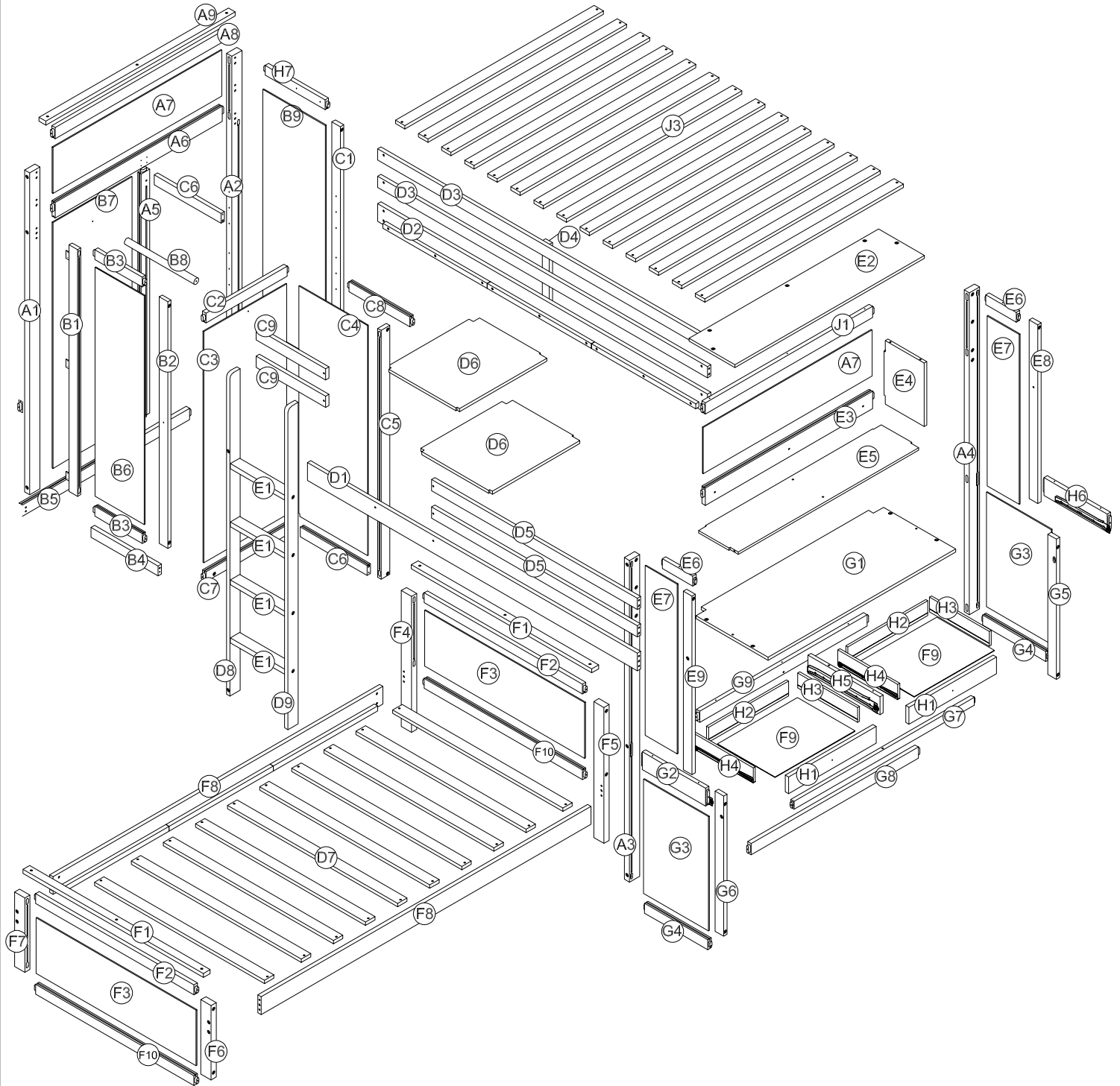

ASSEMBLY INSTRUCTION

INSTRUCTIONS DEMONTAGE



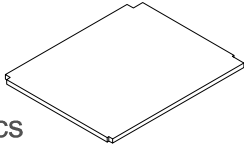
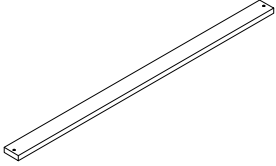
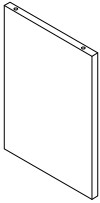
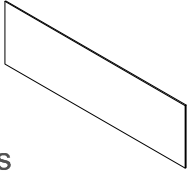

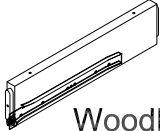
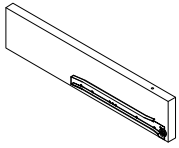
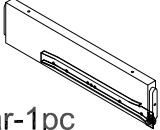
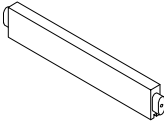
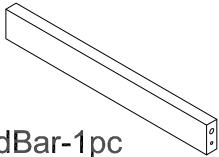
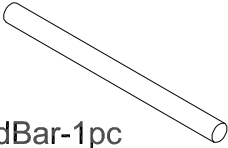
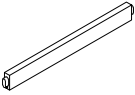
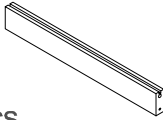
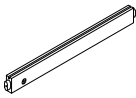
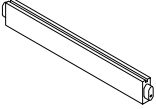
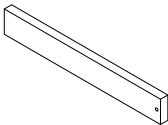
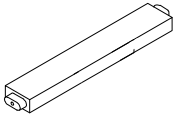
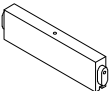

Part List (Box 1 - N708P387817)

Liste des pièces et liste du matériel

D6  Panel-2pcs Planche	D7  Slats-10pcs Lattes	E4  Panel-1pc Planche
F3  Panel-2pcs Planche	F4  Leg-1pc Jambe	F5  Leg-1pc Jambe
F6  Leg-1pc Jambe	F7  Leg-1pc Jambe	G2  WoodBar-1pc Barres de bois
H5  WoodBar-1pc Barres de bois	H6  WoodBar-1pc Barres de bois	B3  WoodBar-2pcs Barres de bois
B4  WoodBar-1pc Barres de bois	B8  WoodBar-1pc Barres de bois	C2  WoodBar-1pc Barres de bois
C6  WoodBar-2pcs Barres de bois	C7  WoodBar-1pc Barres de bois	C8  WoodBar-1pc Barres de bois
C9  WoodBar-2pcs Barres de bois	E1  WoodBar-4pcs Barres de bois	E6  WoodBar-2pcs Barres de bois

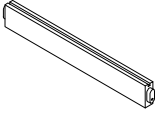
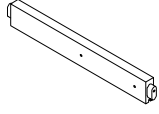
Part List (Box 1 - N708P387817)

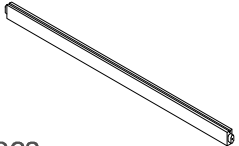
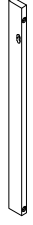
Liste des pièces

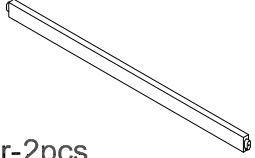
G4  WoodBar-2pcs Barres de bois	H7  WoodBar-1pc Barres de bois	E8  WoodBar-1pc Barres de bois
E9  WoodBar-1pc Barres de bois	F10  WoodBar-2pcs Barres de bois	G5  WoodBar-1pc Barres de bois
G6  WoodBar-1pc Barres de bois	F2  WoodBar-2pcs Barres de bois	

Part List (Box 2 - N708P387818)

Liste des pièces

H2

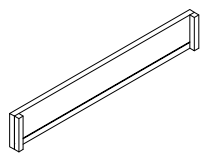

Panel-2pcs
Planche

H3

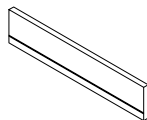

Panel-2pcs
Planche

H4

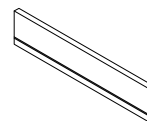

Panel-2pcs
Planche

A1



Leg-1pc
Jambe

A2



Leg-1pc
Jambe

A3



Leg-1pc
Jambe

A4



Leg-1pc
Jambe

A9

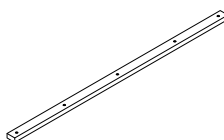

WoodBar-1pc
Barres de bois

D4



WoodBar-1pc
Barres de bois

D1

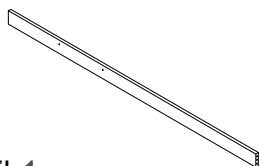

Side Rail-1pc
Rail latéral

D2

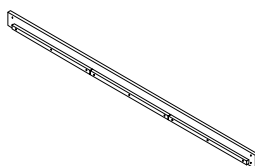

Side Rail-1pc
Rail latéral

D3

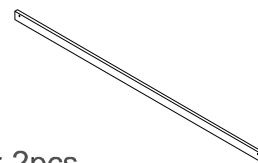

WoodBar-2pcs
Barres de bois

D5

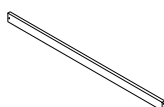

WoodBar-2pcs
Barres de bois

D8



WoodBar-1pc
Barres de bois

D9

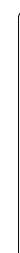

WoodBar-1pc
Barres de bois

F8

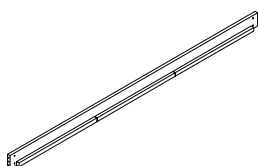

Side Rail-2pcs
Rail latéral

H1

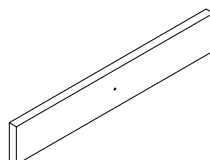

Panel-2pcs
Planche



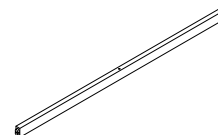







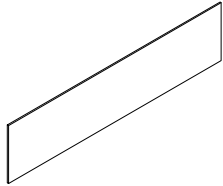
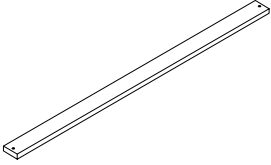

G7

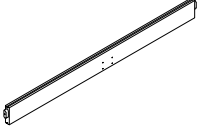
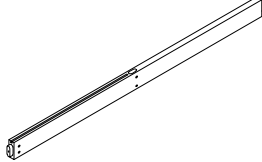

WoodBar-1pc
Barres de bois

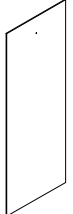
Part List (Box 3 - N708P387819)

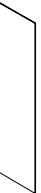
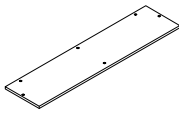
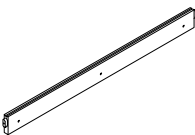
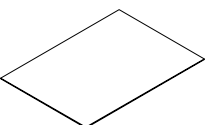
Liste des pièces

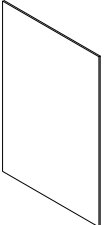
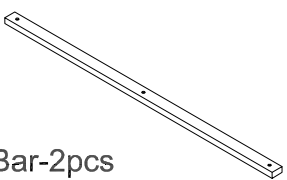
<p>A7</p>  <p>Panel-2pcs Planche</p>	<p>J3</p>  <p>Slats-14pcs Lattes</p>	<p>C1</p>  <p>WoodBar-1pc Barres de bois</p>
<p>A8</p>  <p>WoodBar-1pc Barres de bois</p>	<p>A5</p>  <p>WoodBar-1pc Barres de bois</p>	<p>A6</p>  <p>WoodBar-1pc Barres de bois</p>
<p>B5</p>  <p>WoodBar-1pc Barres de bois</p>	<p>B1</p>  <p>WoodBar-1pc Barres de bois</p>	<p>B2</p>  <p>WoodBar-1pc Barres de bois</p>
<p>B9</p>  <p>Panel-1pc Planche</p>	<p>B6</p>  <p>Panel-1pc Planche</p>	<p>B7</p>  <p>Panel-1pc Planche</p>
<p>C5</p>  <p>WoodBar-1pc Barres de bois</p>	<p>C3</p>  <p>Panel-1pc Planche</p>	<p>C4</p>  <p>Panel-1pc Planche</p>
<p>E2</p>  <p>Panel-1pc Planche</p>	<p>E3</p>  <p>WoodBar-1pc Barres de bois</p>	<p>F9</p>  <p>Panel-2pcs Planche</p>
<p>E7</p>  <p>Panel-2pcs Planche</p>	<p>G3</p>  <p>Panel-2pcs Planche</p>	<p>F1</p>  <p>WoodBar-2pcs Barres de bois</p>

Part List (Box 3 - N708P387819)

Liste des pièces

E5

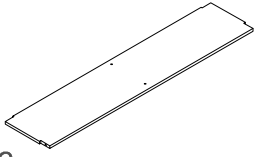

Panel-1pc
Planche

G1

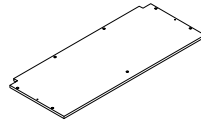

Panel-1pc
Planche

G8

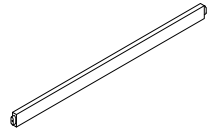

WoodBar-1pc
Barres de bois

G9

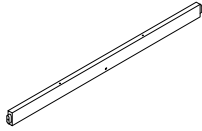

WoodBar-1pc
Barres de bois



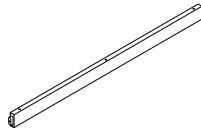





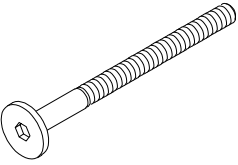
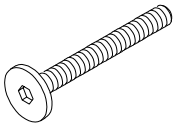
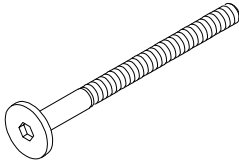
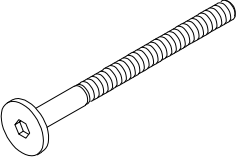

J1

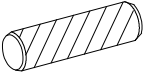

WoodBar-1pc
Barres de bois

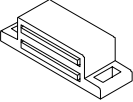
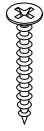
Hardware List (Box 2 - N708P387818)

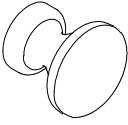
Liste des pièces

<p>1</p>  <p>Bolts Ø1/4" x 80 mm - 30pcs Boulon</p>	<p>2</p>  <p>Bolts Ø1/4" x 60mm - 20pcs Boulon</p>	<p>3</p>  <p>Bolts Ø1/4" x 90mm - 4pcs Boulon</p>
<p>4</p>  <p>Bolts Ø1/4" x 100mm - 32pcs Boulon</p>	<p>5</p>  <p>Screws 1/4" x 60mm - 9pcs Vis</p>	<p>6</p>  <p>Screws 1/4" x 70mm - 3pcs Vis</p>
<p>8</p>  <p>Ø1/4" x 13 mm Horizontal-Hole bolts - 86pcs Boulons à trou horizontal</p>	<p>10</p>  <p>Wood dowel Ø8 x 30 mm - 17 pcs Cheville en bois</p>	<p>11</p>  <p>Allen Key - 1pc Clé Allen</p>
<p>12</p>  <p>Door Catches 45x17x13 - 1pc Loquets de porte</p>	<p>13</p>  <p>Wood Screws M4 x 30mm - 91pcs Les vis à bois</p>	<p>15</p>  <p>Wood Screws M3.5 x 12mm-16pcs Les vis à bois</p>
<p>16</p>  <p>Handle Wood - 3pcs Manche en bois</p>	<p>17</p>  <p>Bolts M4 x 25 mm - 3pcs Boulon</p>	<p>18</p>  <p>Dowel Remove Shelves - 8pcs Goujon Retirer les étagères</p>

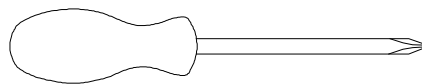

Assembly Tools Required (Not Included)
Outils d'assemblage requis (Non Inclus)

Step 2:
Étape 2:

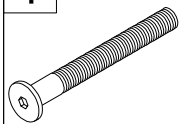
8		1	
8(pcs)		8(pcs)	

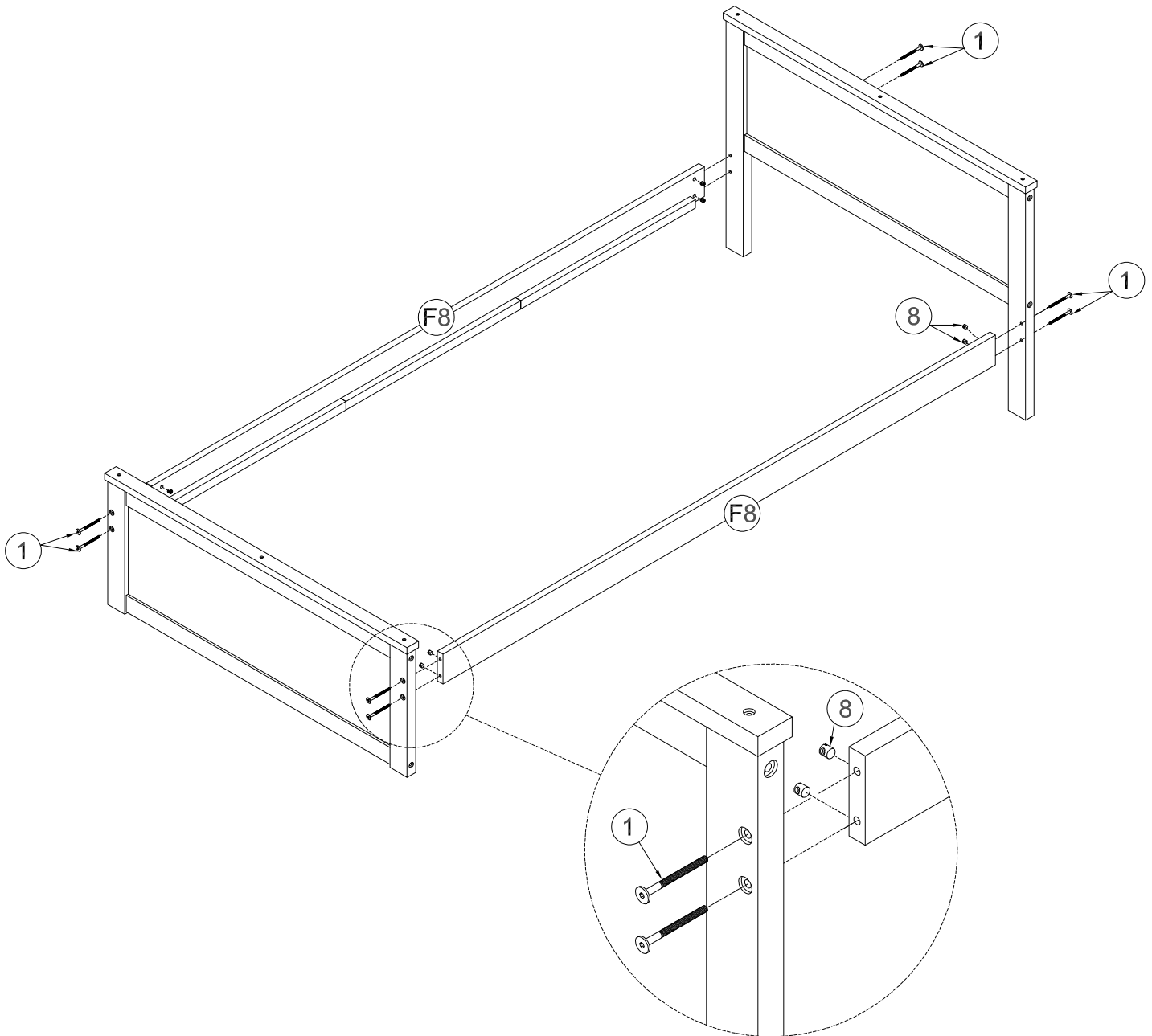

Step 3:
Étape 3:

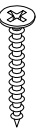

13

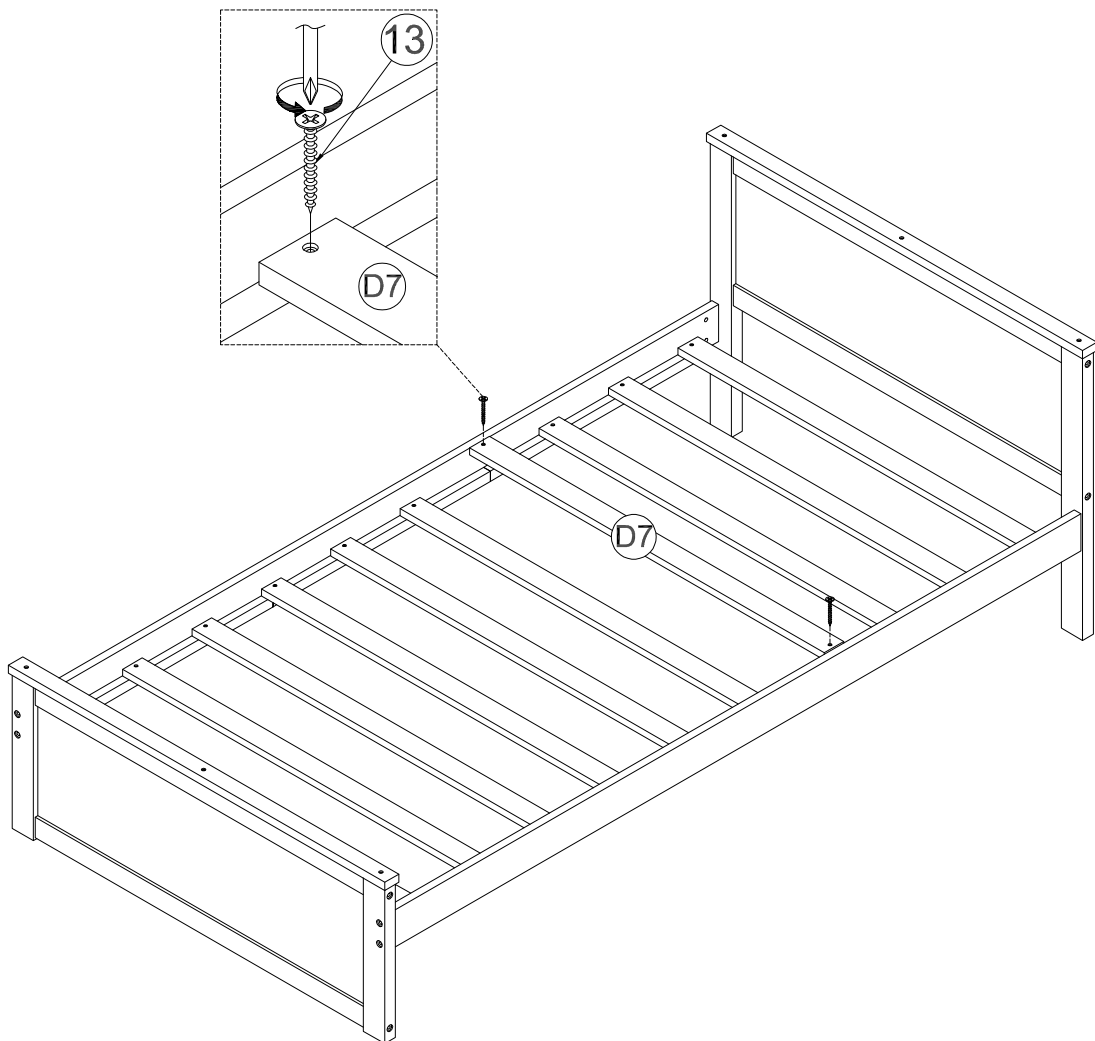

20(pcs)

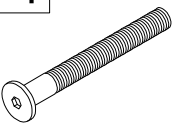
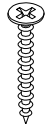

Step 4:
Étape 4:

10		8		4		13	
2(pcs)		6(pcs)		6(pcs)		3(pcs)	

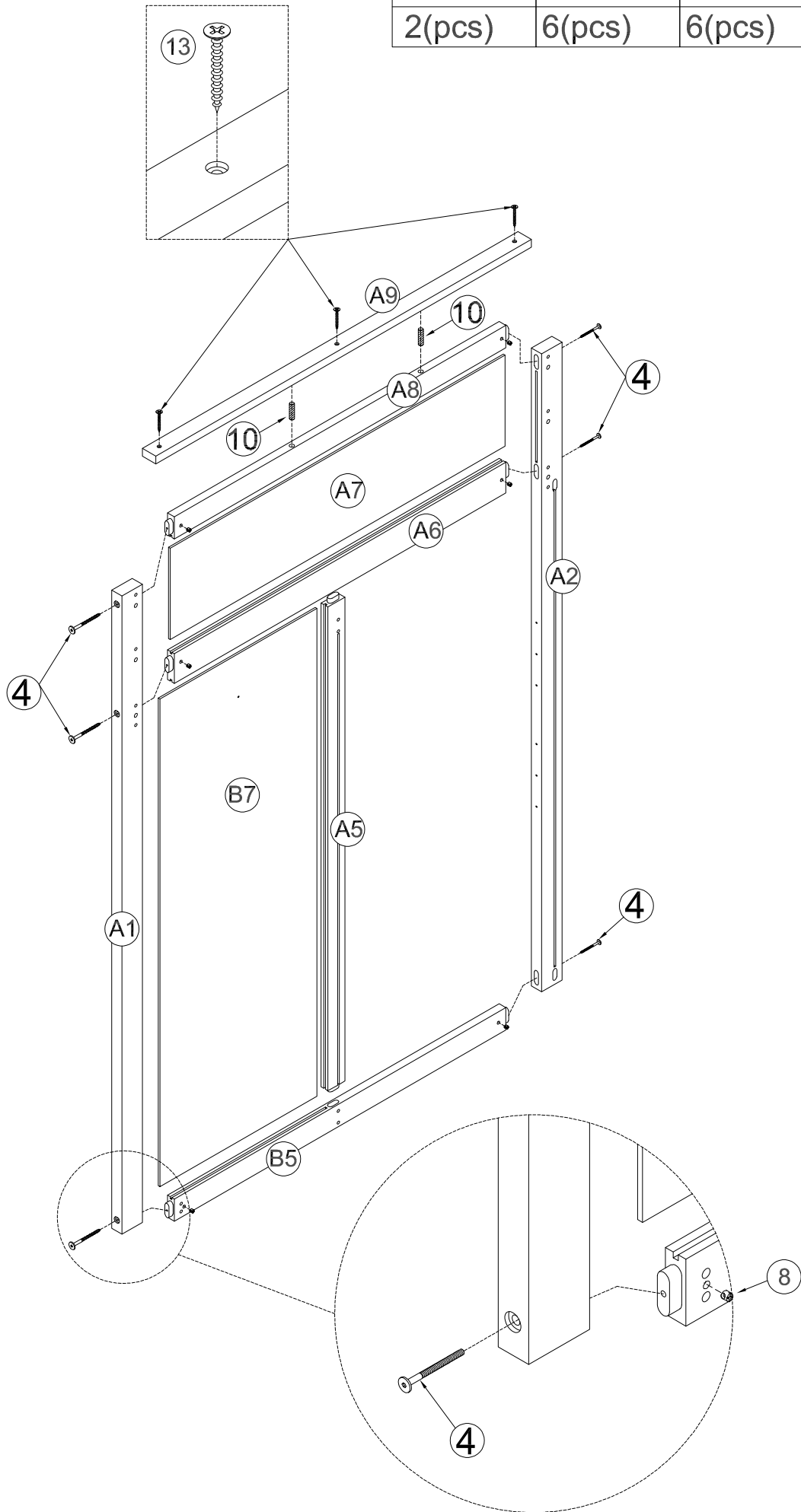

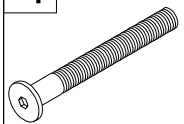

Step 5:
Étape 5:

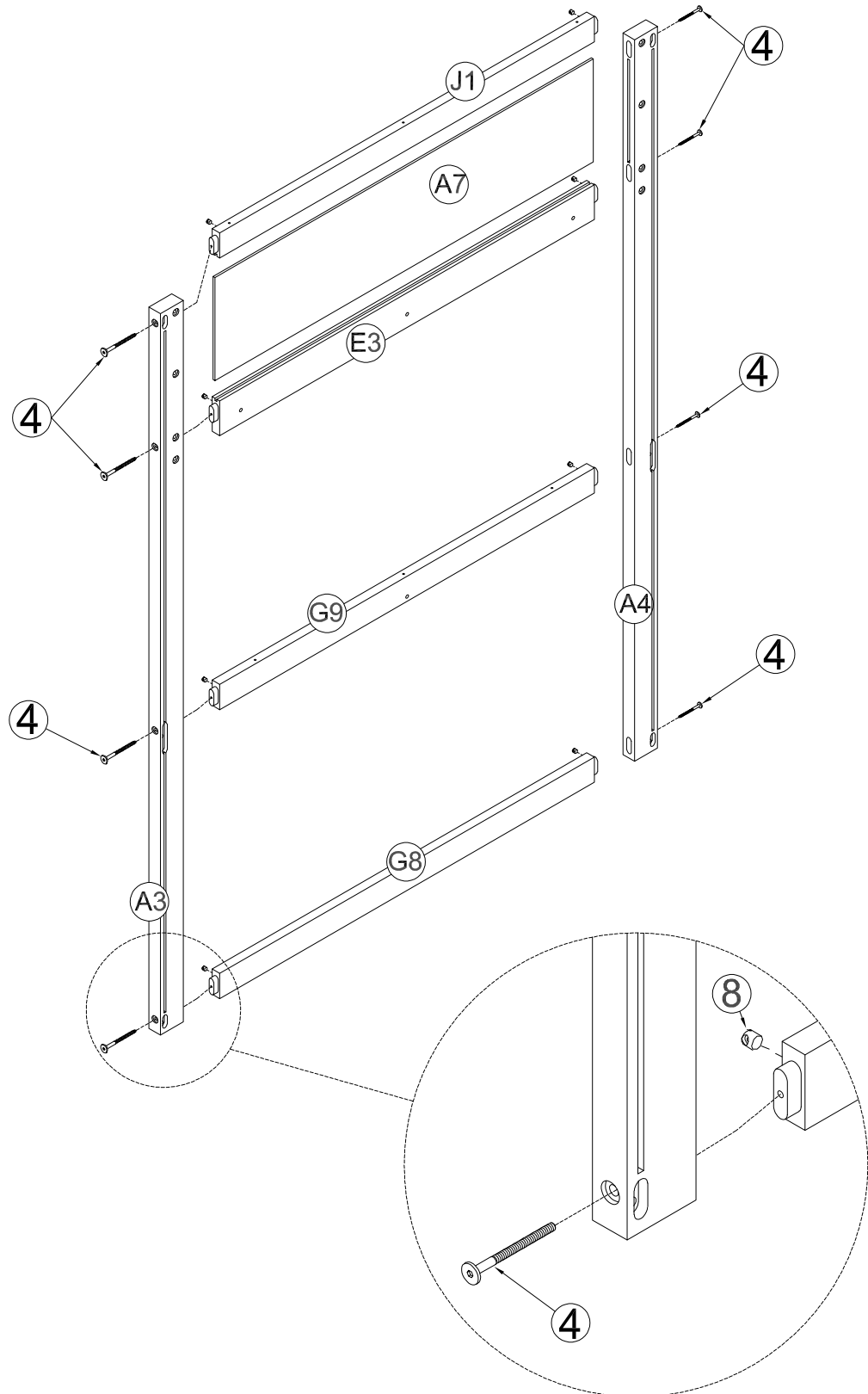
8		4	
8(pcs)		8(pcs)	



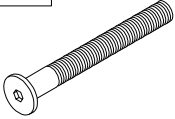

Step 6:
Étape 6:

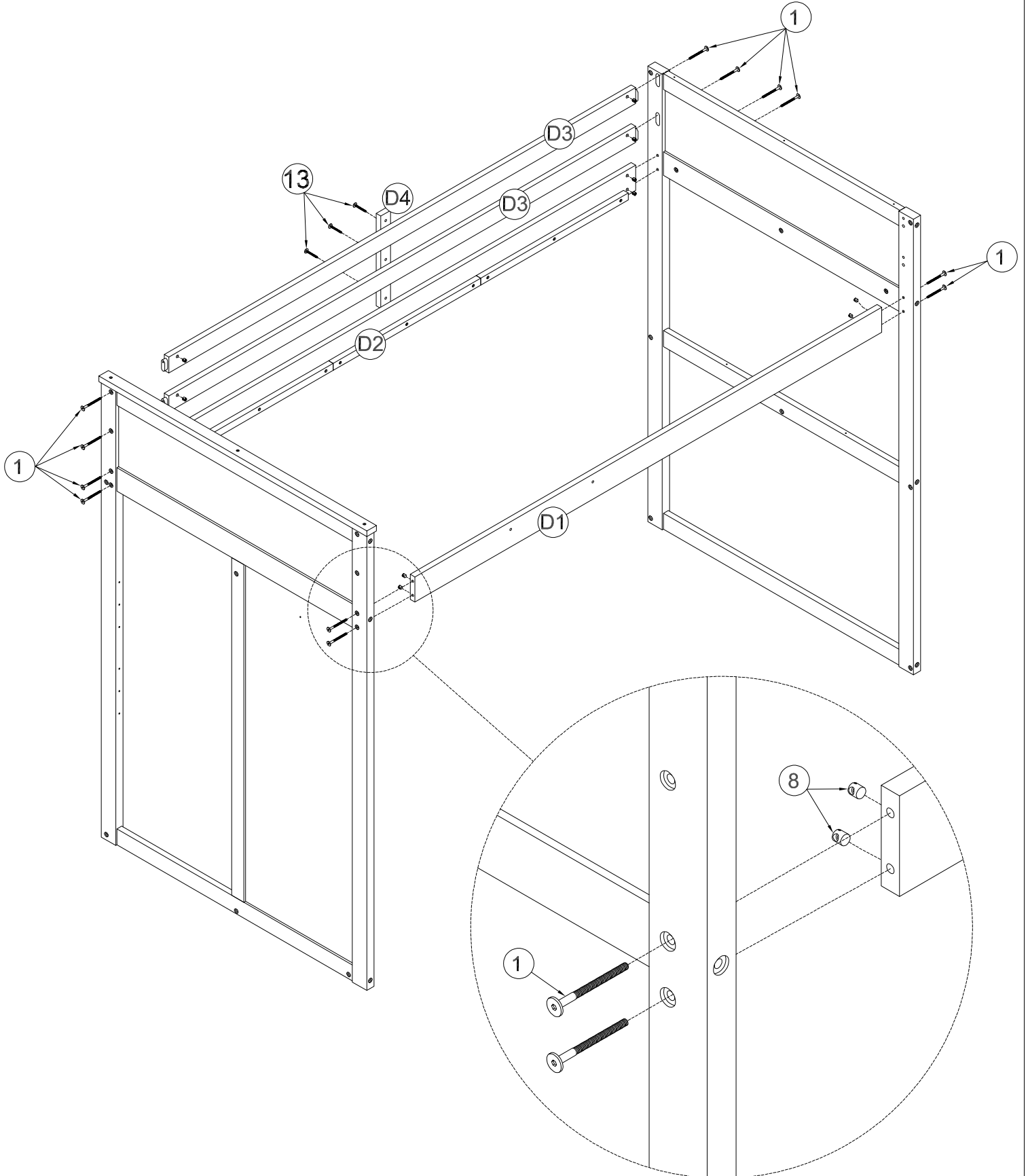
13		8		1	
3(pcs)		12(pcs)		12(pcs)	



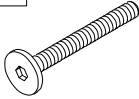

Step 7:
Étape 7:

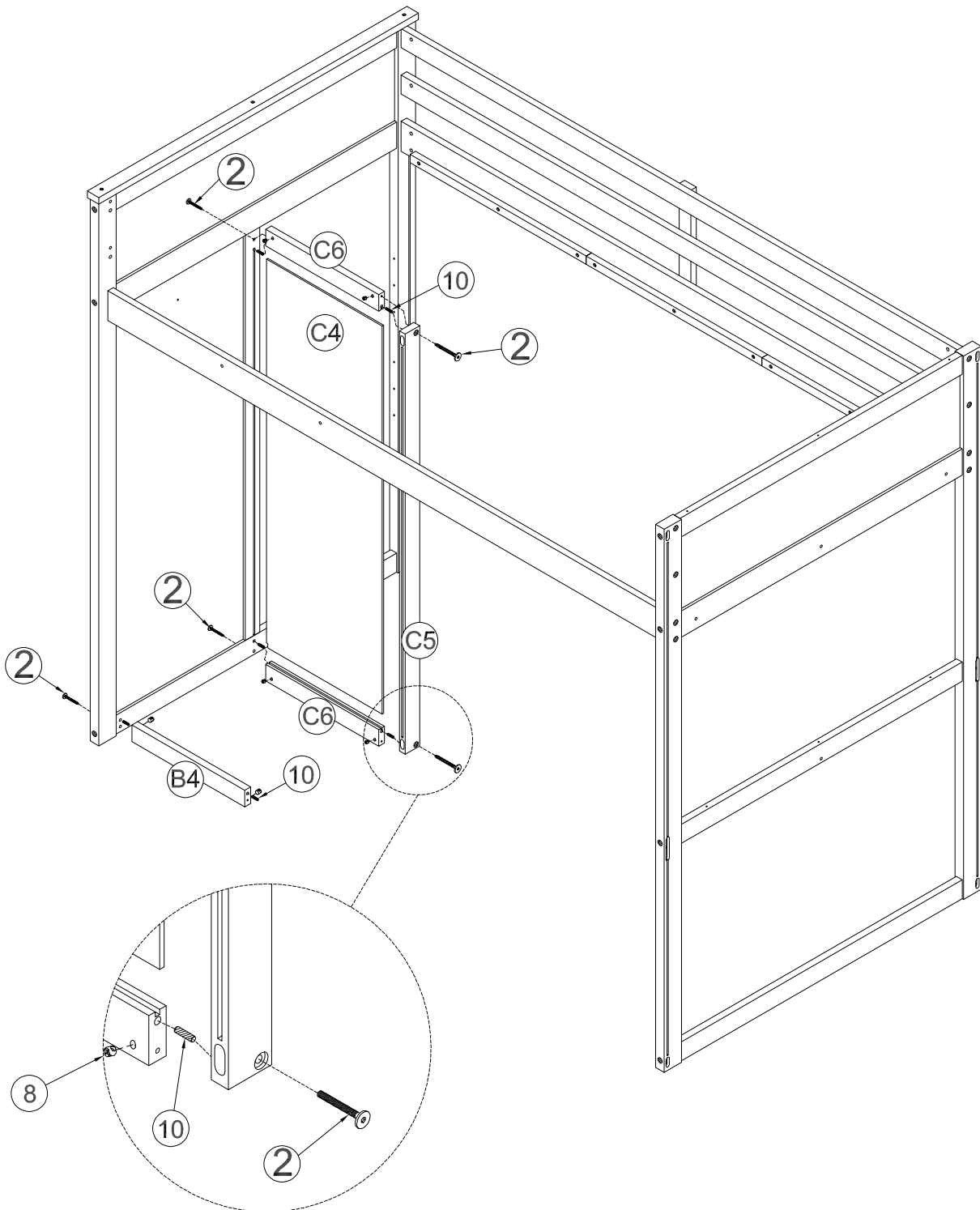
8		2		10	
5(pcs)		5(pcs)		6(pcs)	

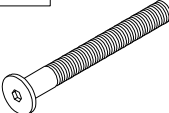
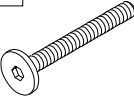

Step 8:
Étape 8:

8		3		2		16		17	
12(pcs)		4(pcs)		8(pcs)		1(pc)		1(pc)	

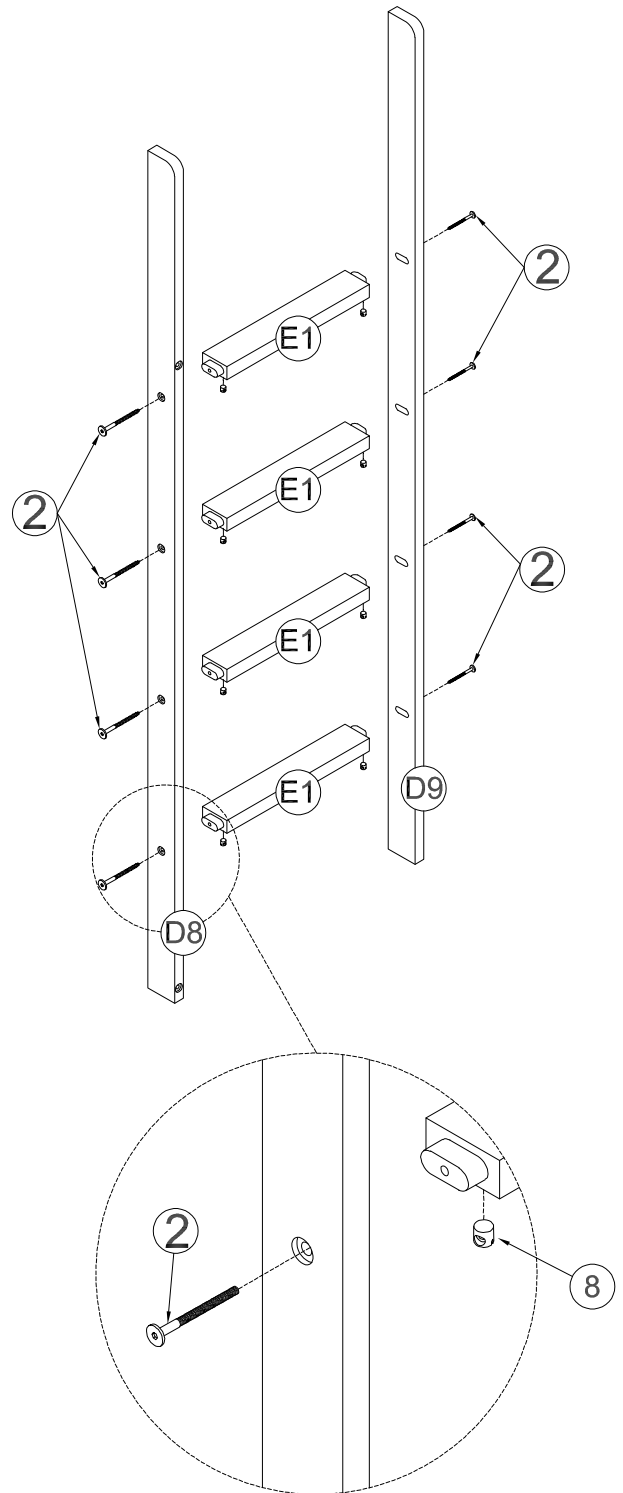
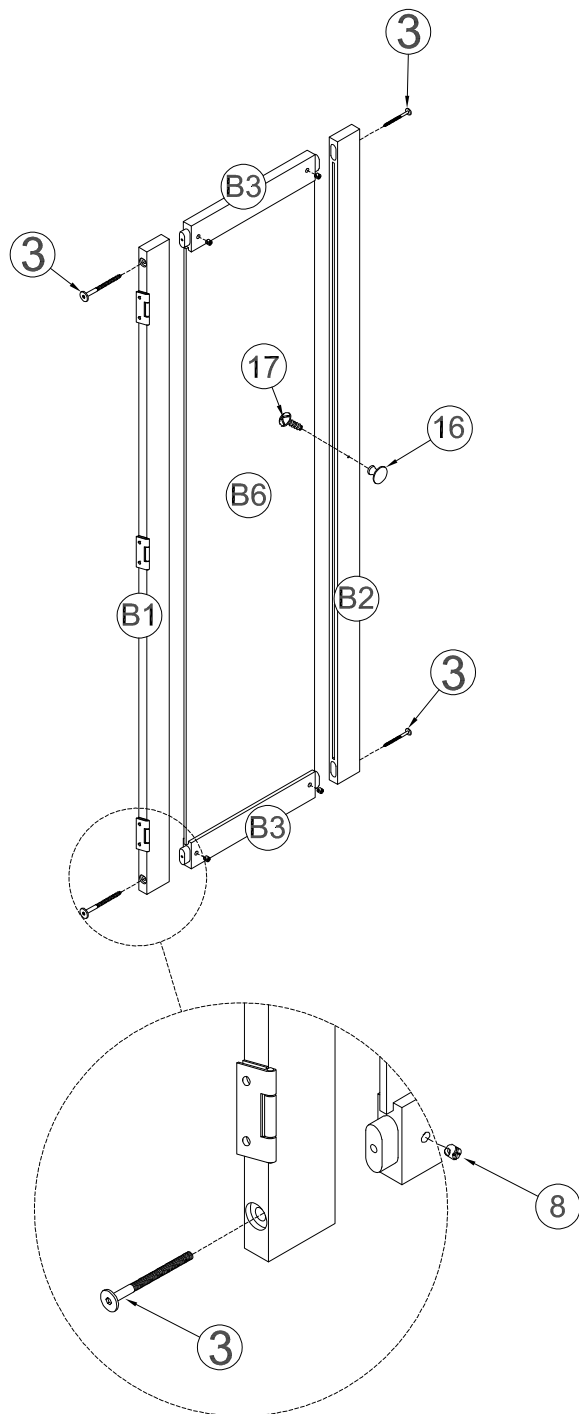

Step 9:
Étape 9:

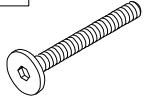
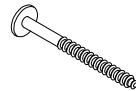
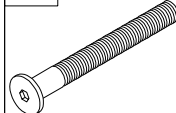
8		2		5		4	
5(pcs)		1(pc)		2(pcs)		4(pcs)	

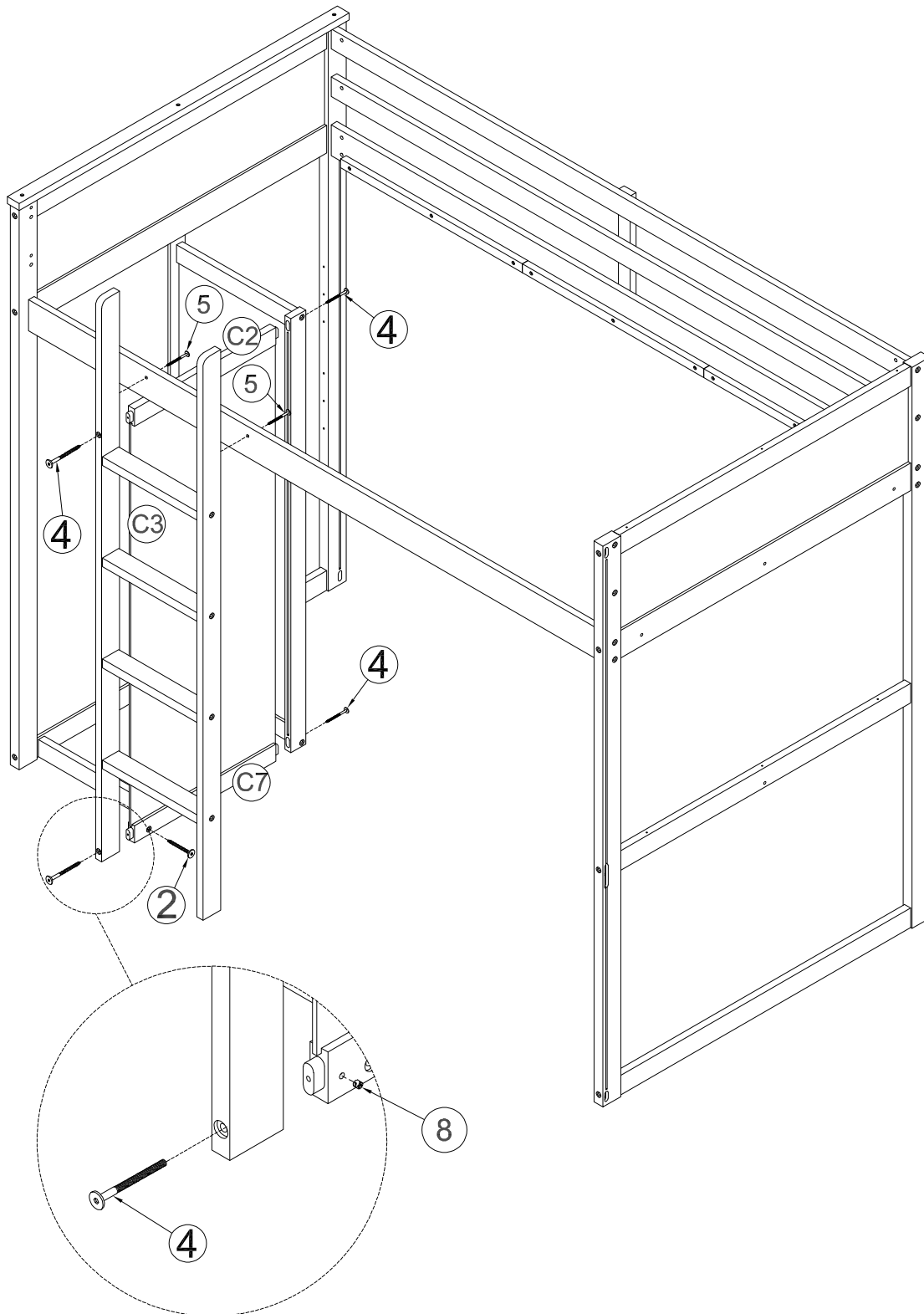



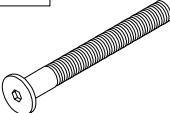
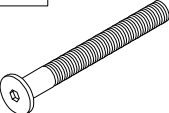
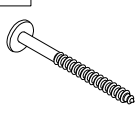
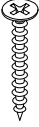

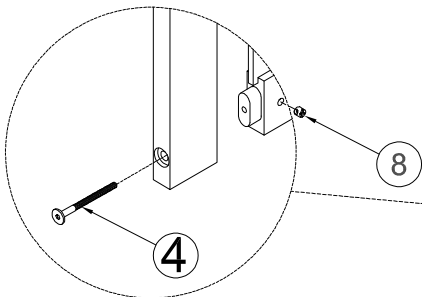
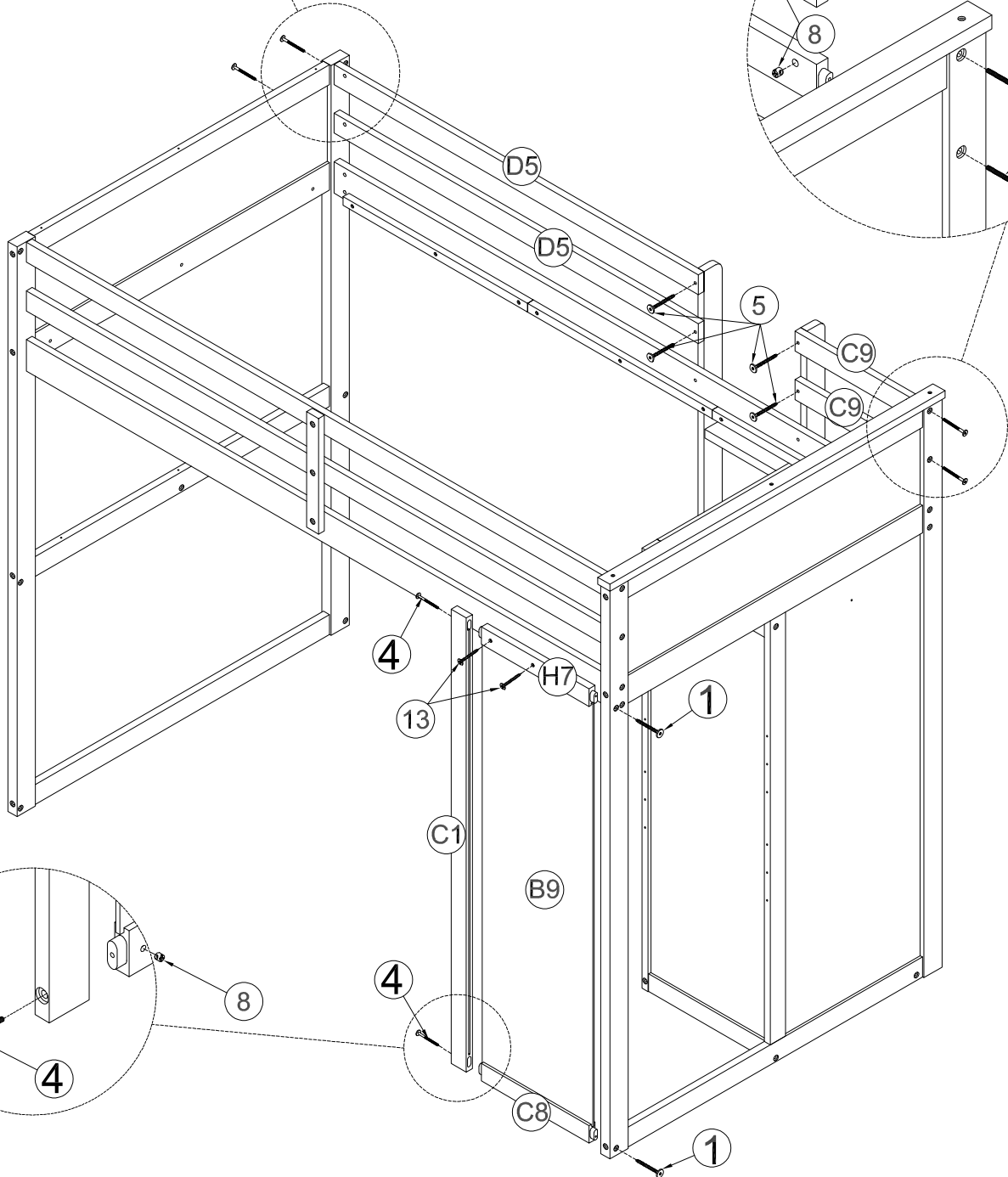
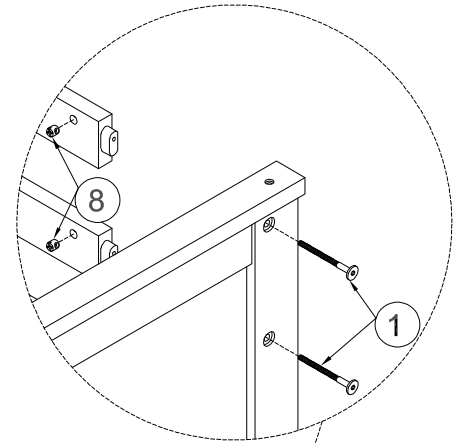
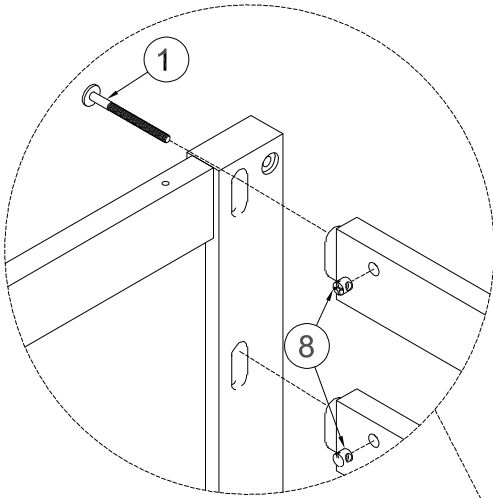
Step 10:
Étape 10:

8	4	1	5	13
				
8(pcs)	2(pcs)	6(pcs)	4(pcs)	2(pcs)

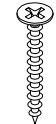

Step 11:
Étape 11:

12	18	13	15
			
1(pc)	8(pcs)	2(pcs)	10(pcs)

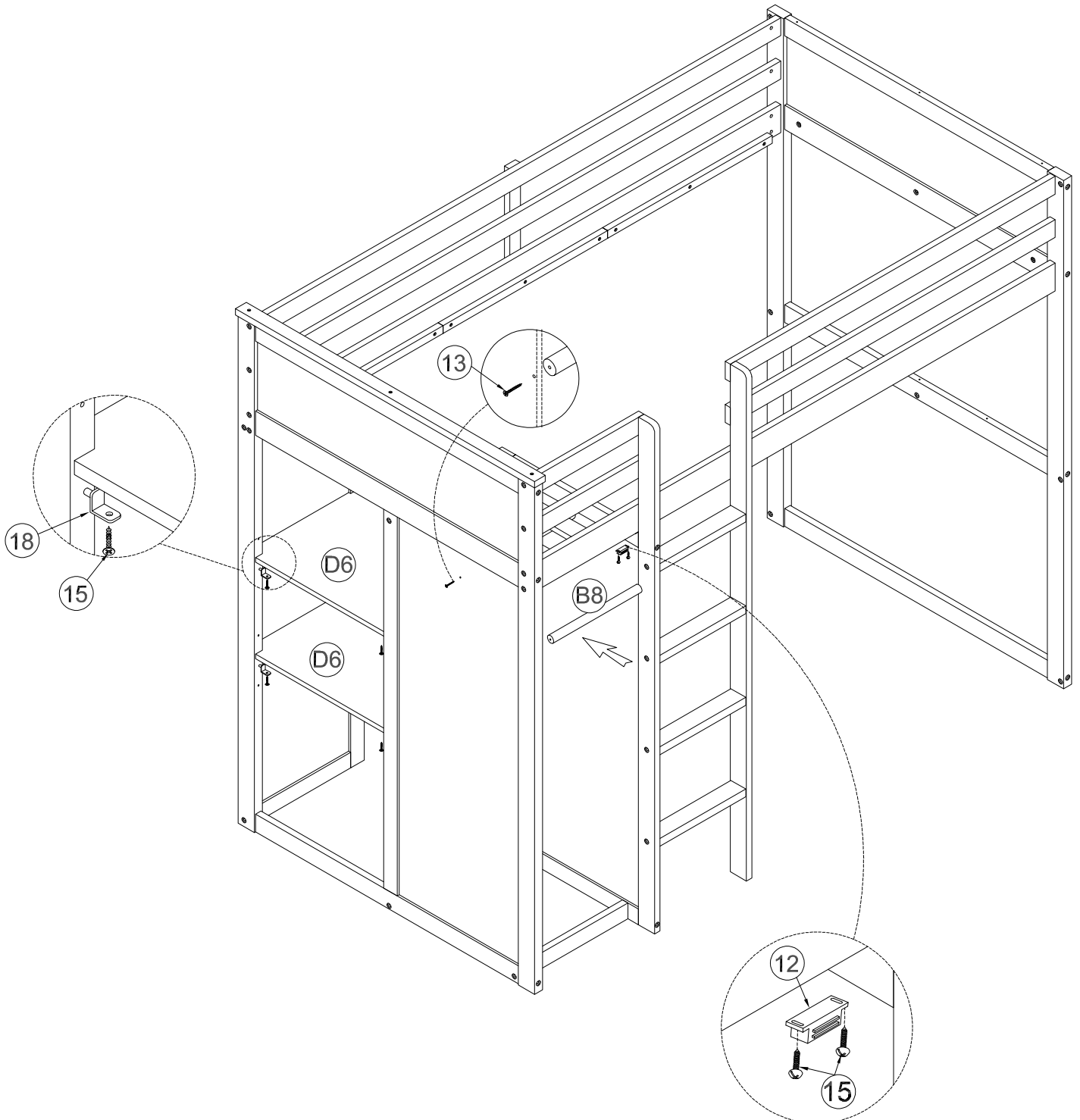

Step 12:
Étape 12:

15



6(pcs)

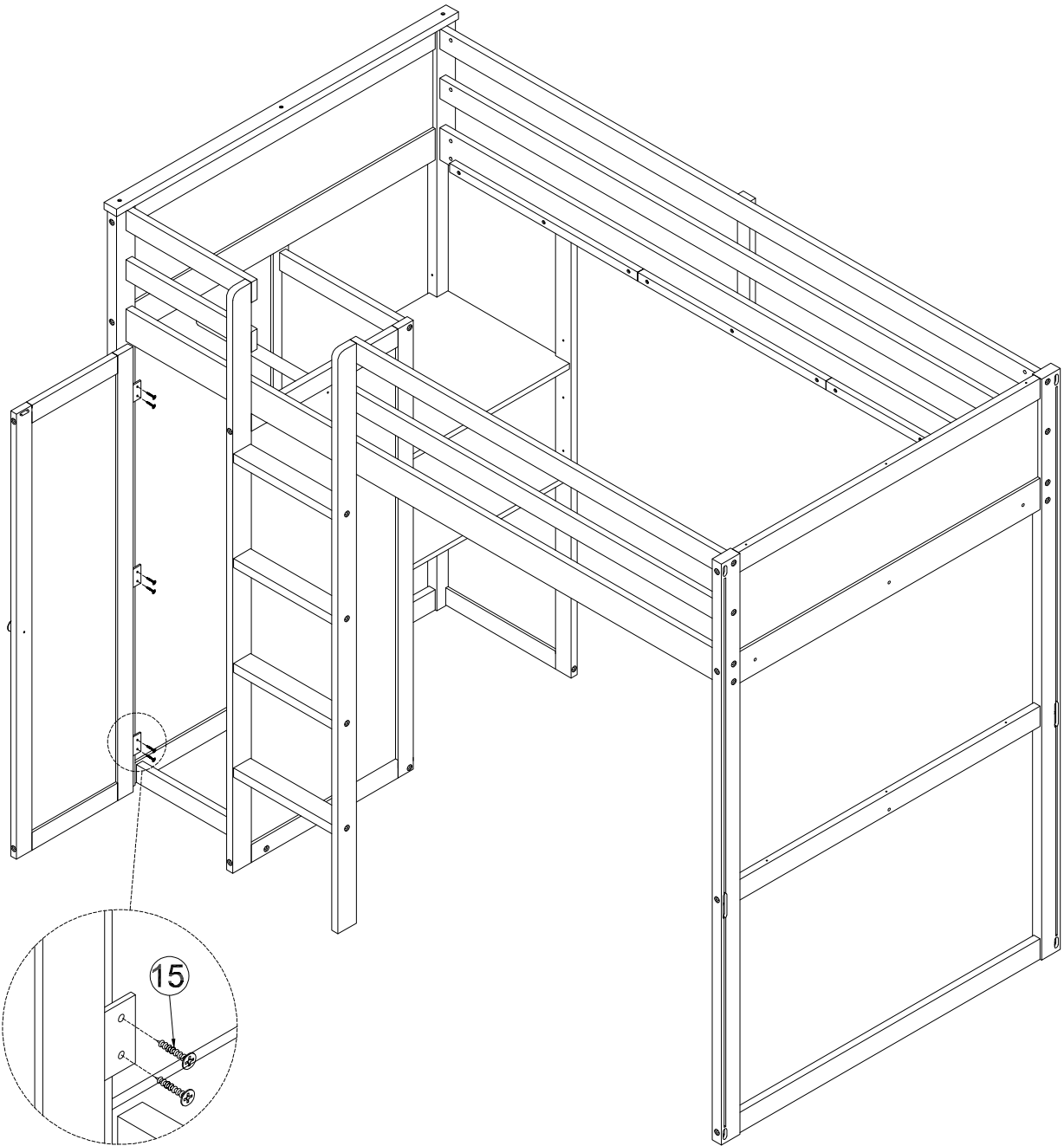

Step 13:
Étape 13:

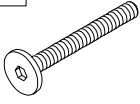
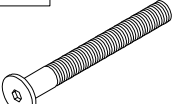
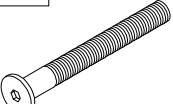
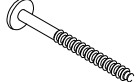
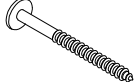
8		2		4		1		6		5	
10(pcs)		2(pcs)		4(pcs)		4(pcs)		1(pc)		1(pc)	

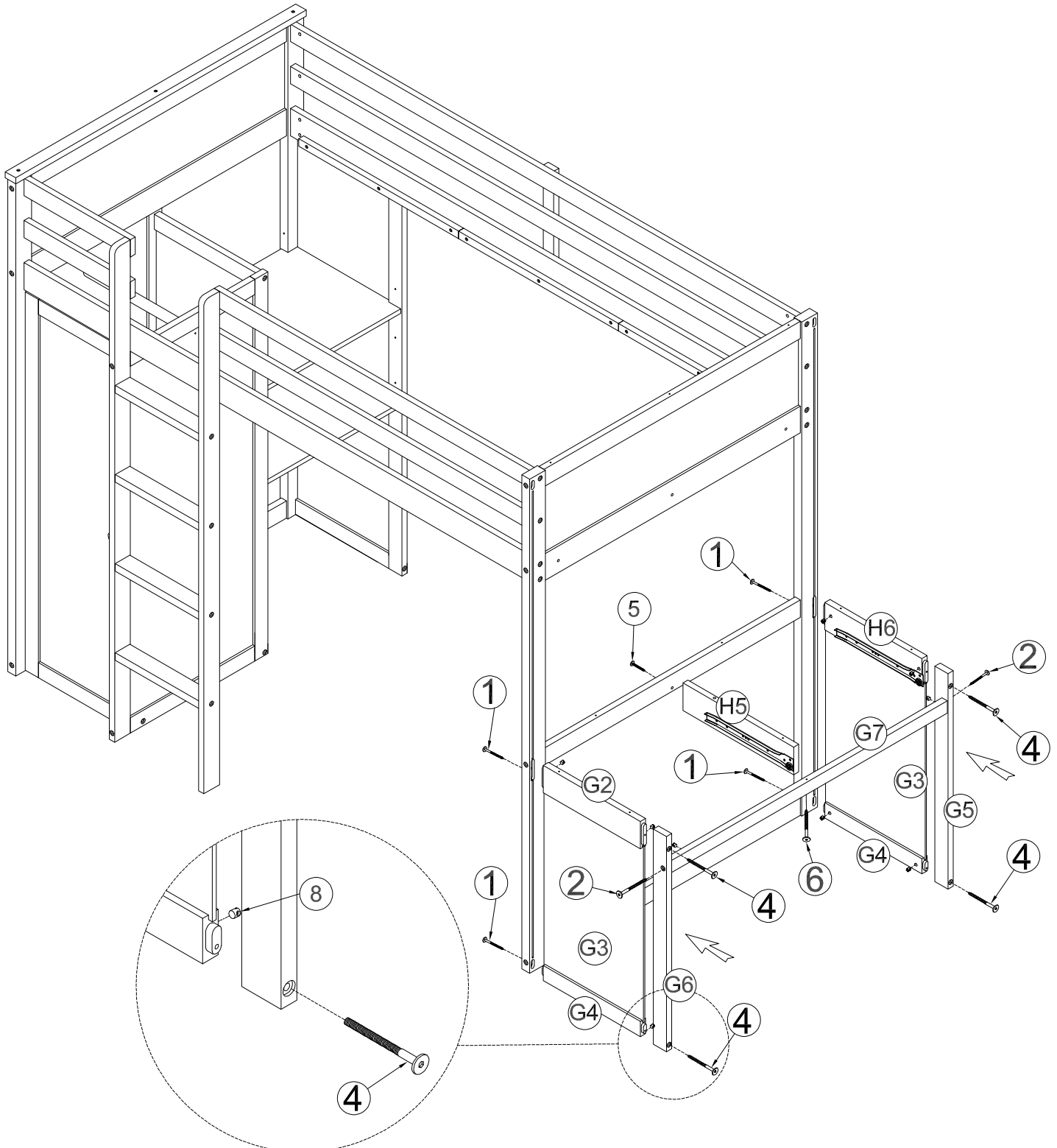

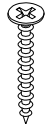

Step 14:
Étape 14:

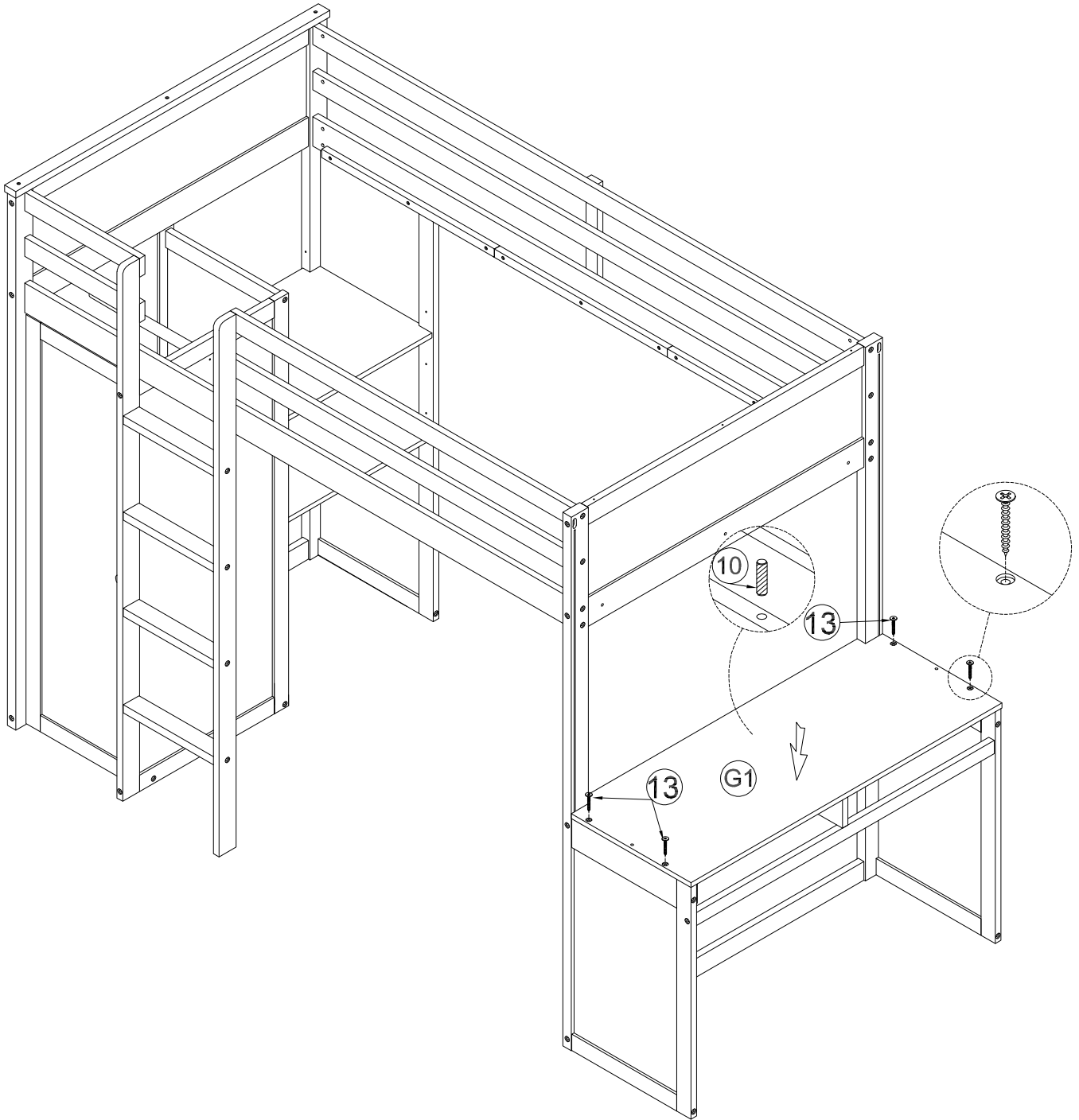
10		13	
1(pc)		4(pcs)	





Note: Put wooden peg first

Step 15:
Étape 15:

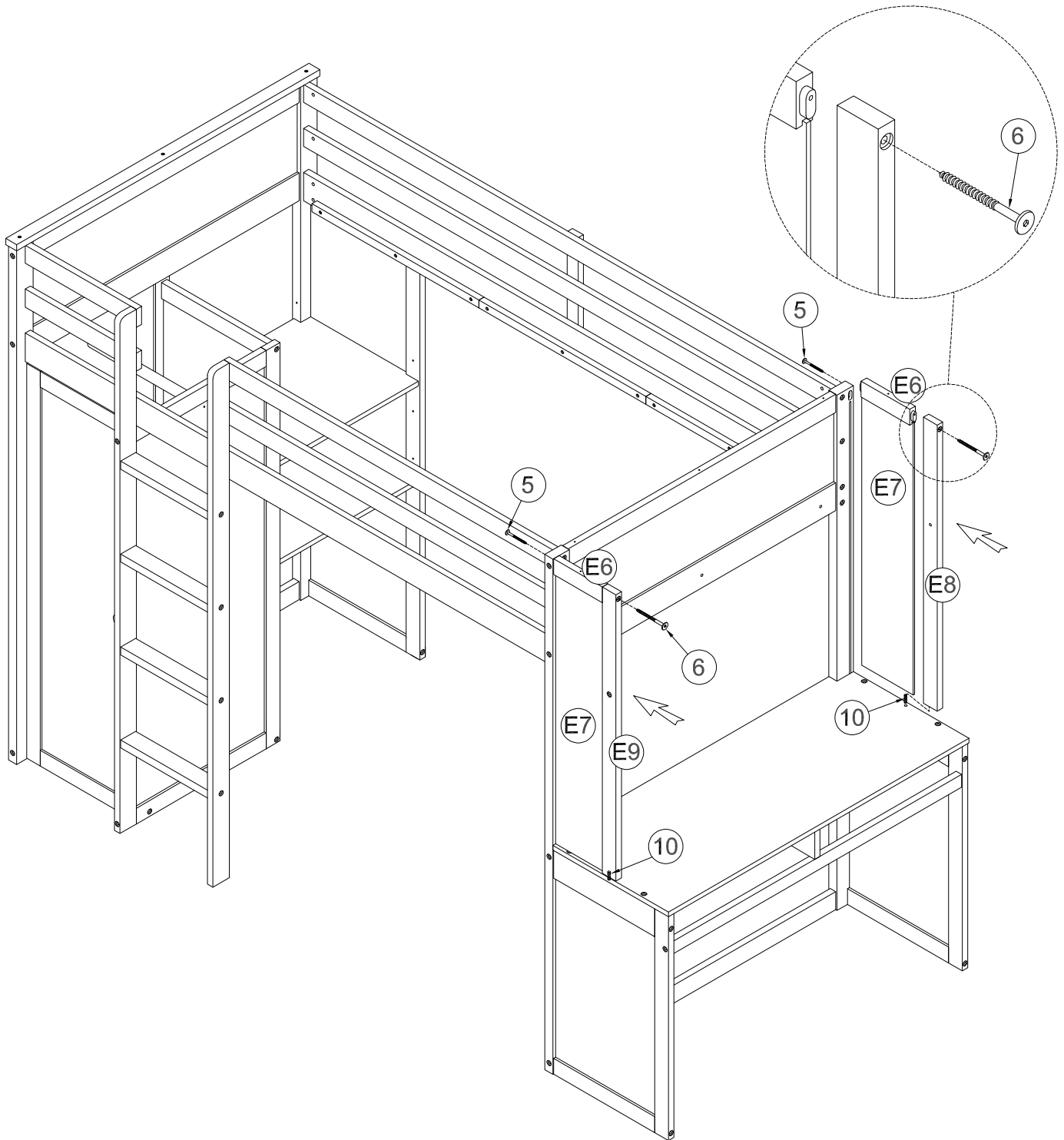
10		5		6	
2(pcs)		2(pcs)		2(pcs)	

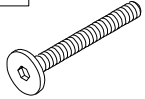
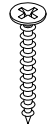

Step 16:
Étape 16:

8		2		13		10	
4(pcs)		4(pcs)		1(pc)		1(pc)	

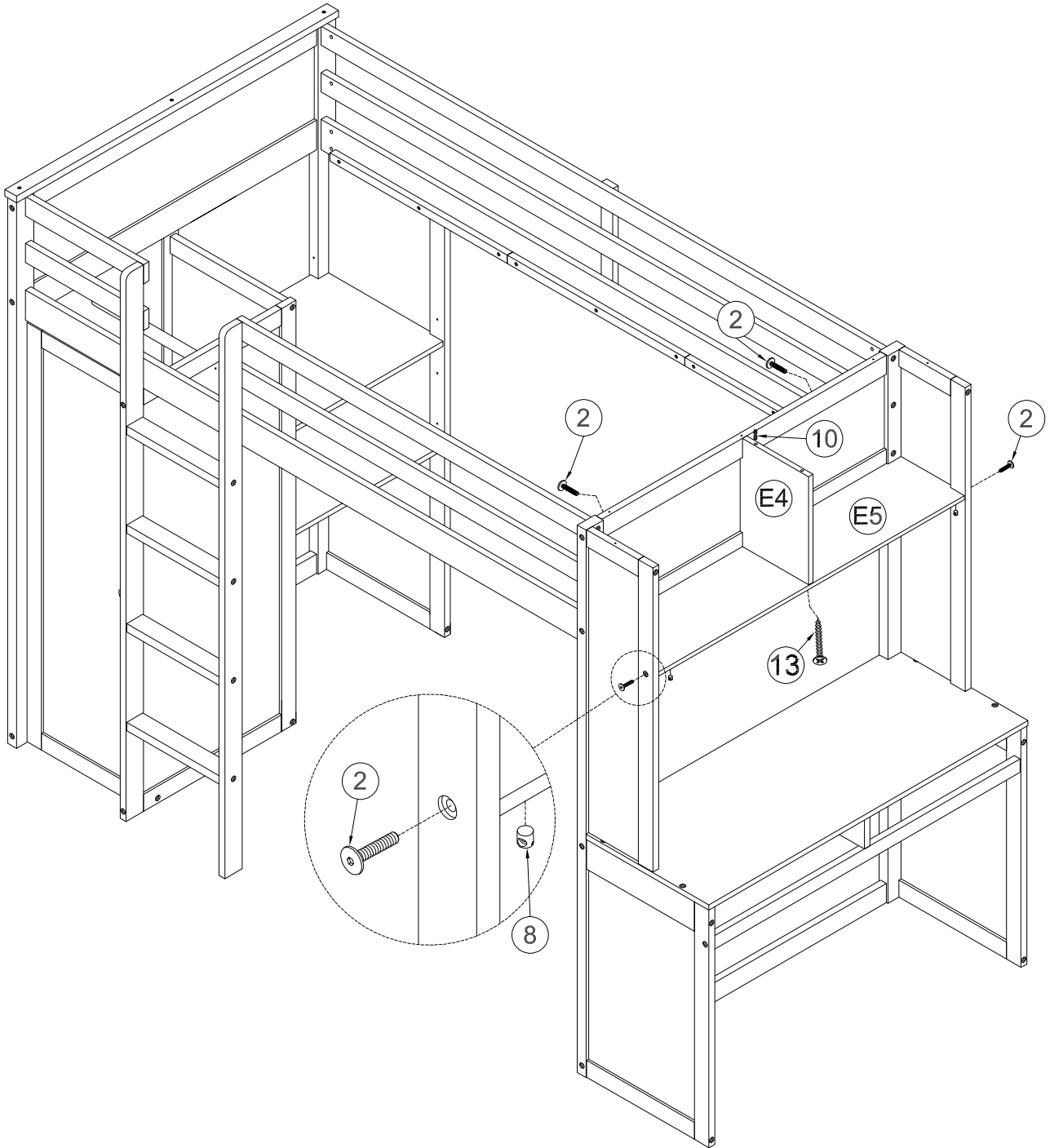

Step 17-1:

Étape 17-1:

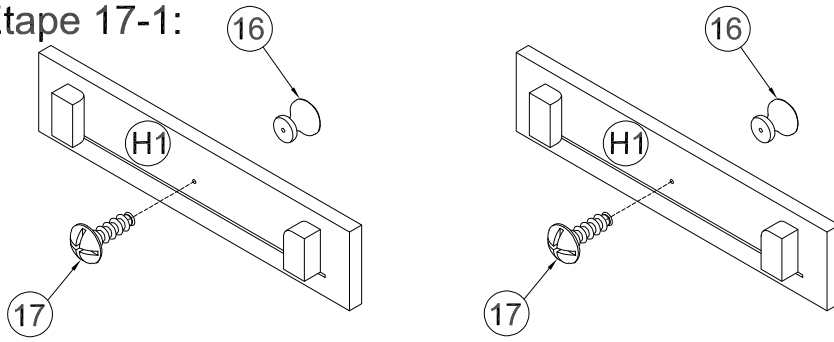

16

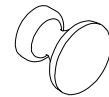

2pcs

17



2pcs

Step 17-2:

Étape 17-2:

X2

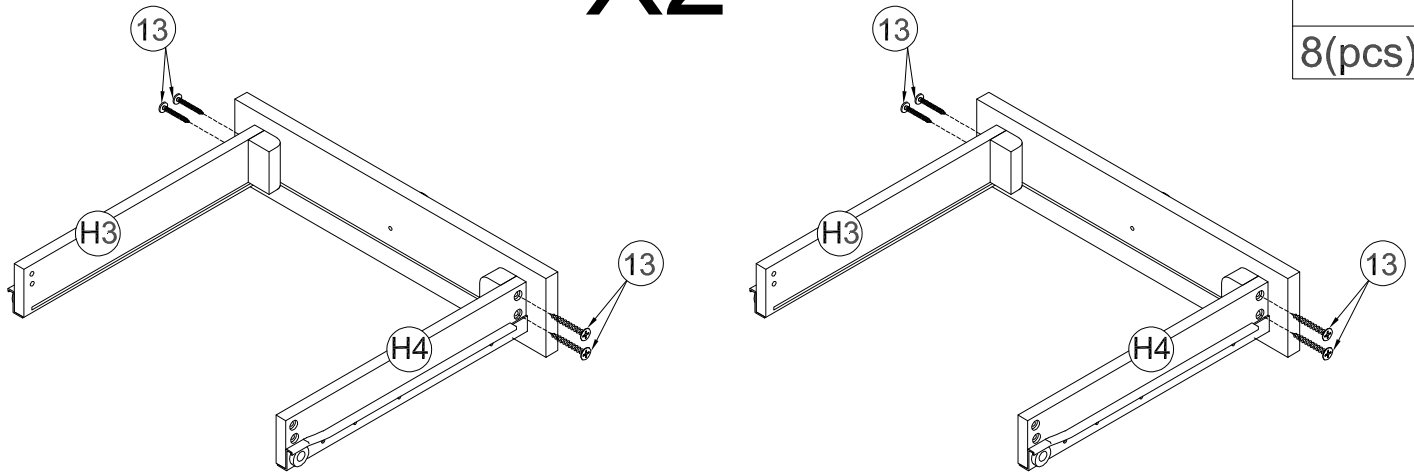

13

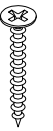

8(pcs)

Step 17-3:

Étape 17-3:

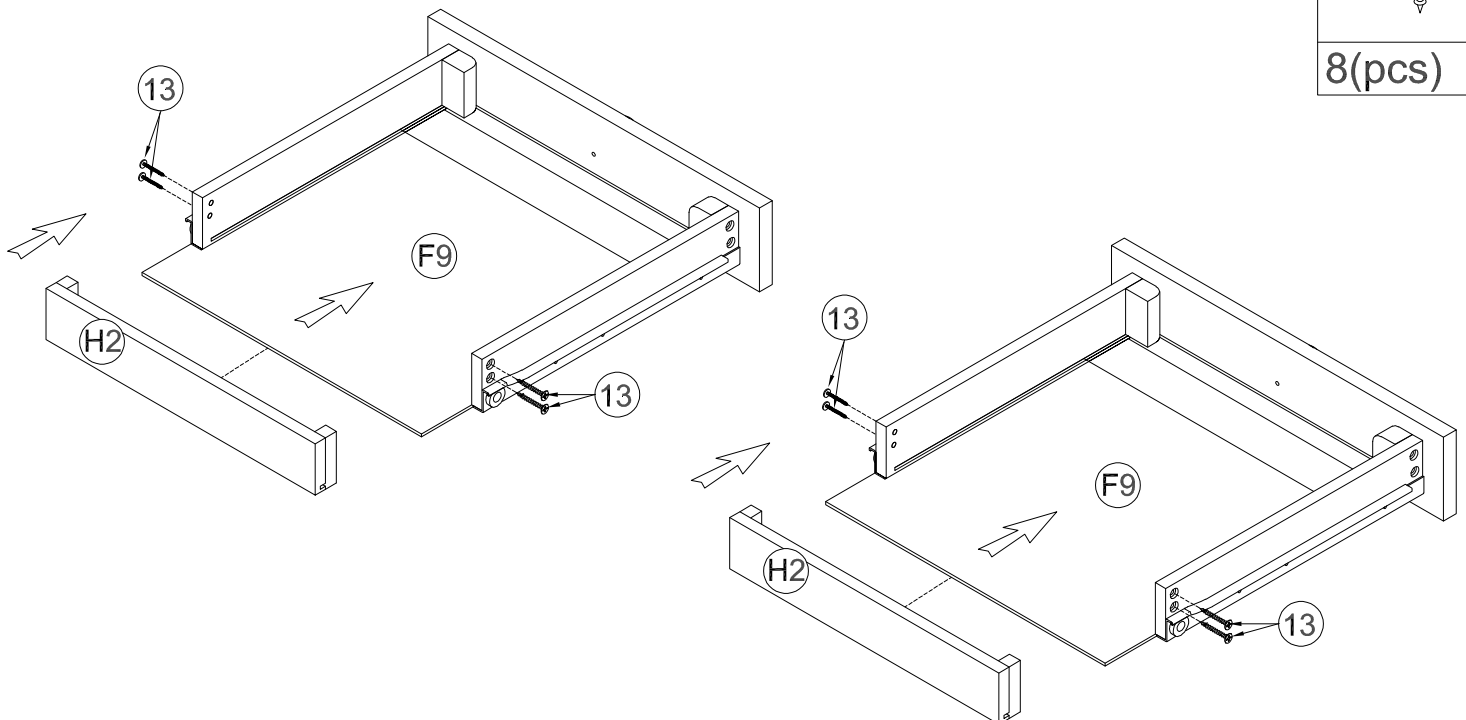

13



8(pcs)

Step 18:
Étape 18:

13

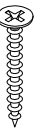

34(pcs)

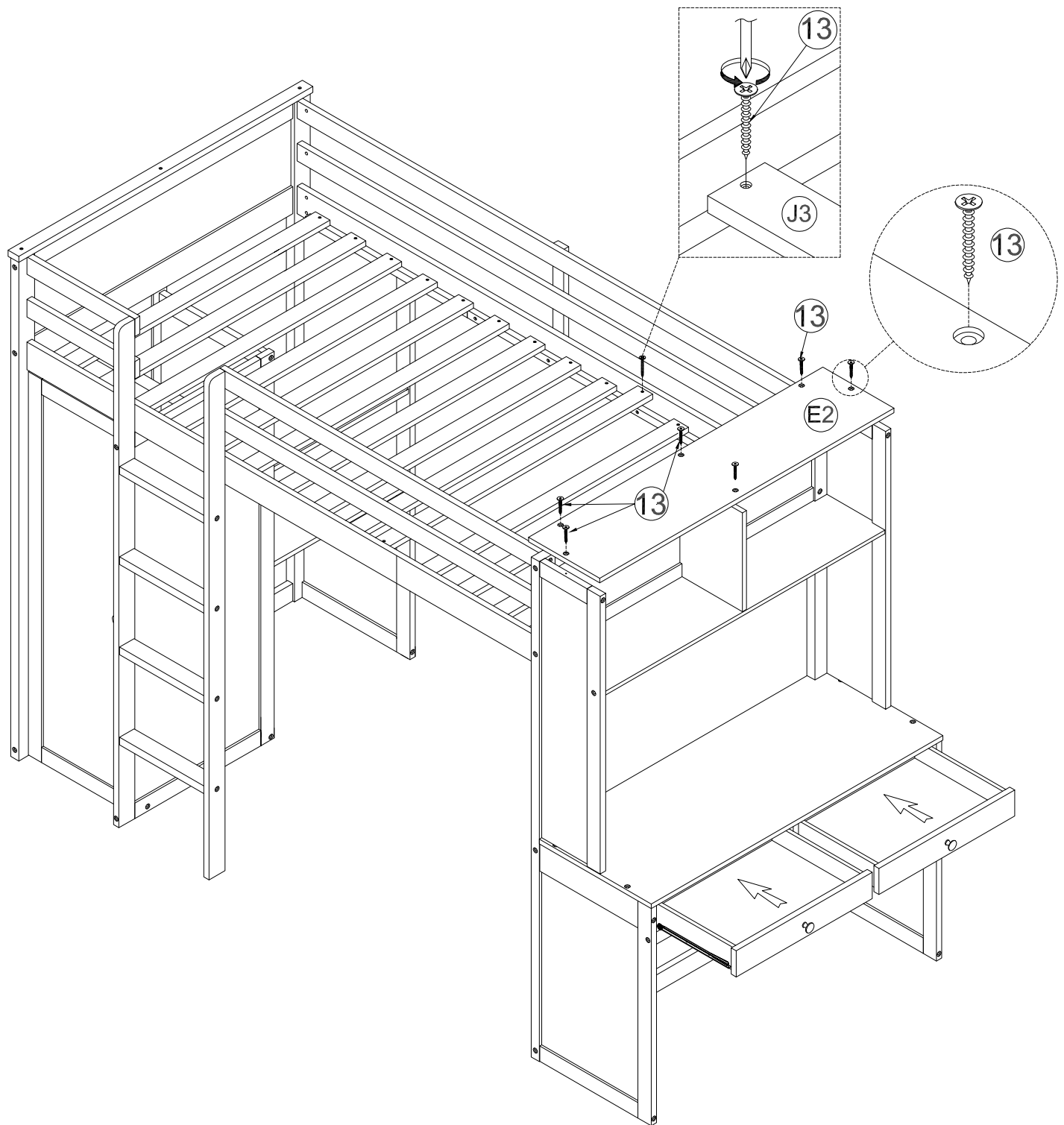

Step 19:
Étape 19:

