

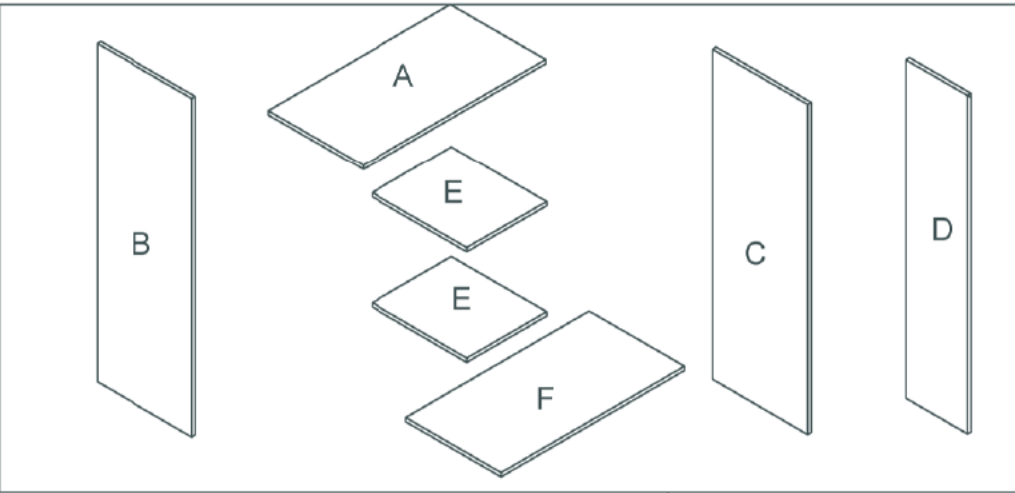





# ASSEMBLY INSTRUCTION

## PART LIST



## HARDWARE LIST

NO.	Diagram	Q' TY
a	M7*38mm 	20
b		2
c		1
d		20
e		4

Step 1

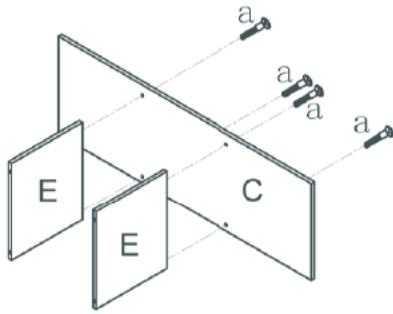

Step 2

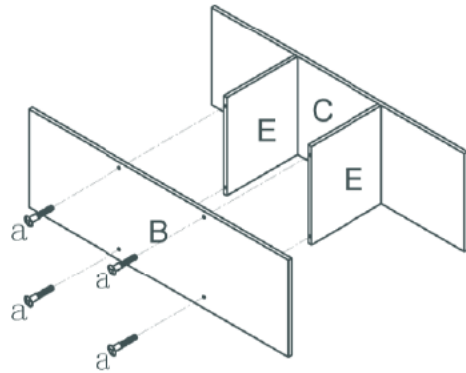

ax4 

ax4 

Step 3

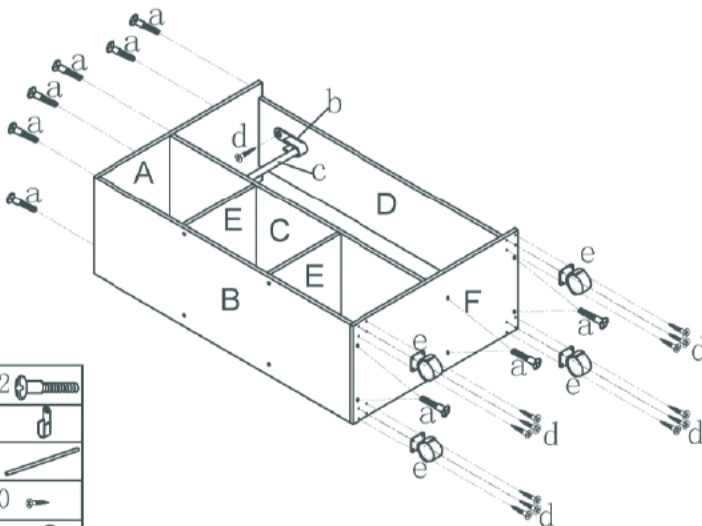

ax12 

bx2 

cx1 

dx20 

ex4 

Step 4

