

Owner Manual

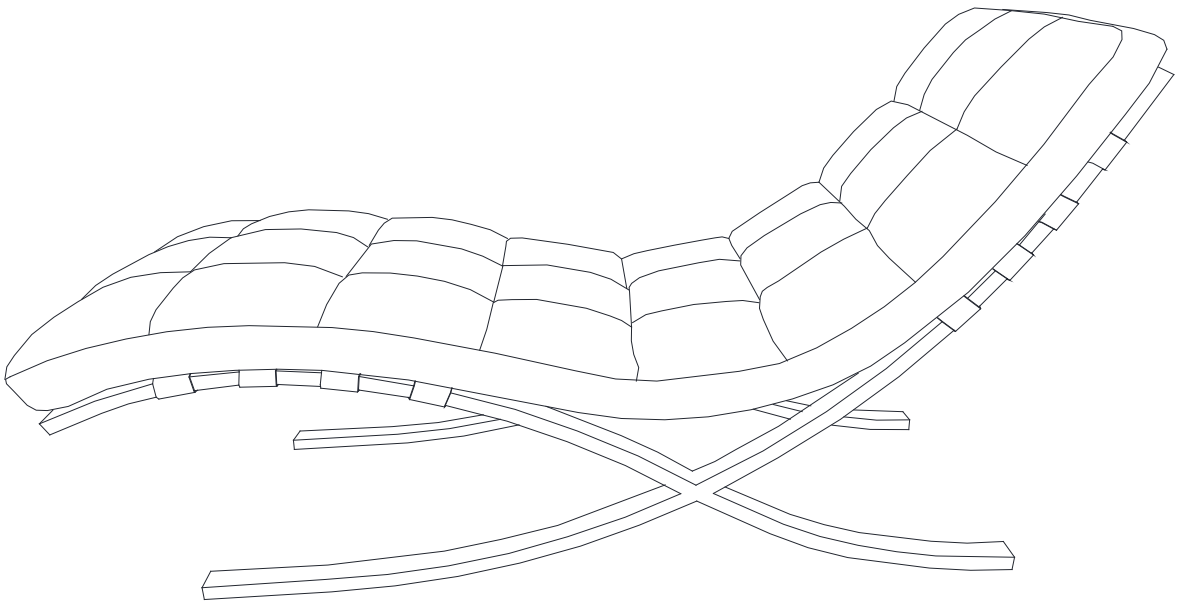

Per Seat Weight Limitation







350 LBS

MAINTAINANCE AND WARNINGS



Before You Start

Please follow the steps below:



-  Un box the package and check if all parts and accessories are complete.
-  Place the parts of the chair on a flat surface.
-  Ensure the chair is placed on a stable, flat surface to prevent it from tilting.
-  Avoid placing sharp or heavy objects directly on the chair to prevent tears or deformation.
-  Clean the installation area in advance and ensure the ground is level and there is enough space to avoid damaging the furniture or making installation difficult.
-  Lay a protective mat on the ground to prevent scratching the floor during installation.

After-Sales Service

- If you encounter any issues or need technical support during use, please contact our after-sales team. We offer long-term maintenance and warranty services.





Precautions

-  This chair is for indoor use only. Do not expose it to outdoor elements or high-humidity environments.
-  Keep the product away from high heat or open flames to prevent fire hazards.
-  Do not allow children or pets to play on the chair unsupervised to avoid accidents.



Safety Warnings

-  If you notice any loose or damaged parts, stop using the sofa immediately and contact customer service.
-  Do not attempt to disassemble or replace any components yourself, as this may affect the stability and safety of the product.

Daily Maintenance

- Regularly clean the surface of the sofa with a chair cloth to prevent dust accumulation.
- For fabric chairs, it is recommended to vacuum weekly and clean the fabric as needed.
- For leather chairs, use a leather cleaner regularly to clean and maintain the material. Avoid direct sunlight to prevent leather aging.
- In case of spills, immediately blot the area with a clean, dry cloth

Parts List

A

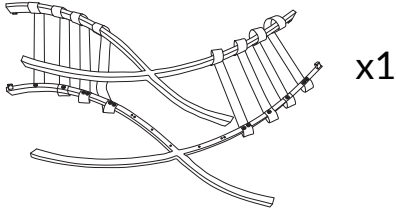

Railing

B

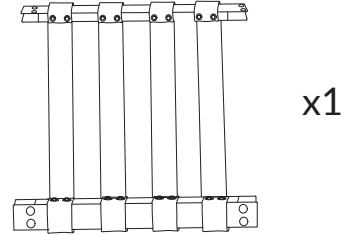

Middle support pole

C

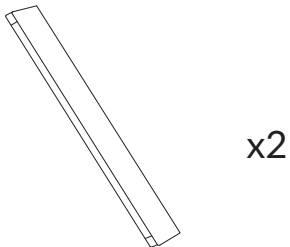

Crossbar

D

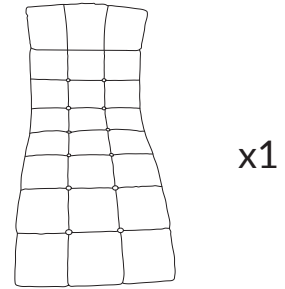

Bearn bag





Installation:
15minutes.

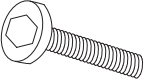

Two Person

Hardware List

<p>1</p>  <p>x17+1</p> <p>1/4x15MM</p>	<p>2</p>  <p>x1</p>	

Step 1

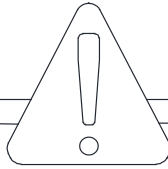

The belt in "B" needs to be rotated around the square tube, if it has been turned, please ignore this step.

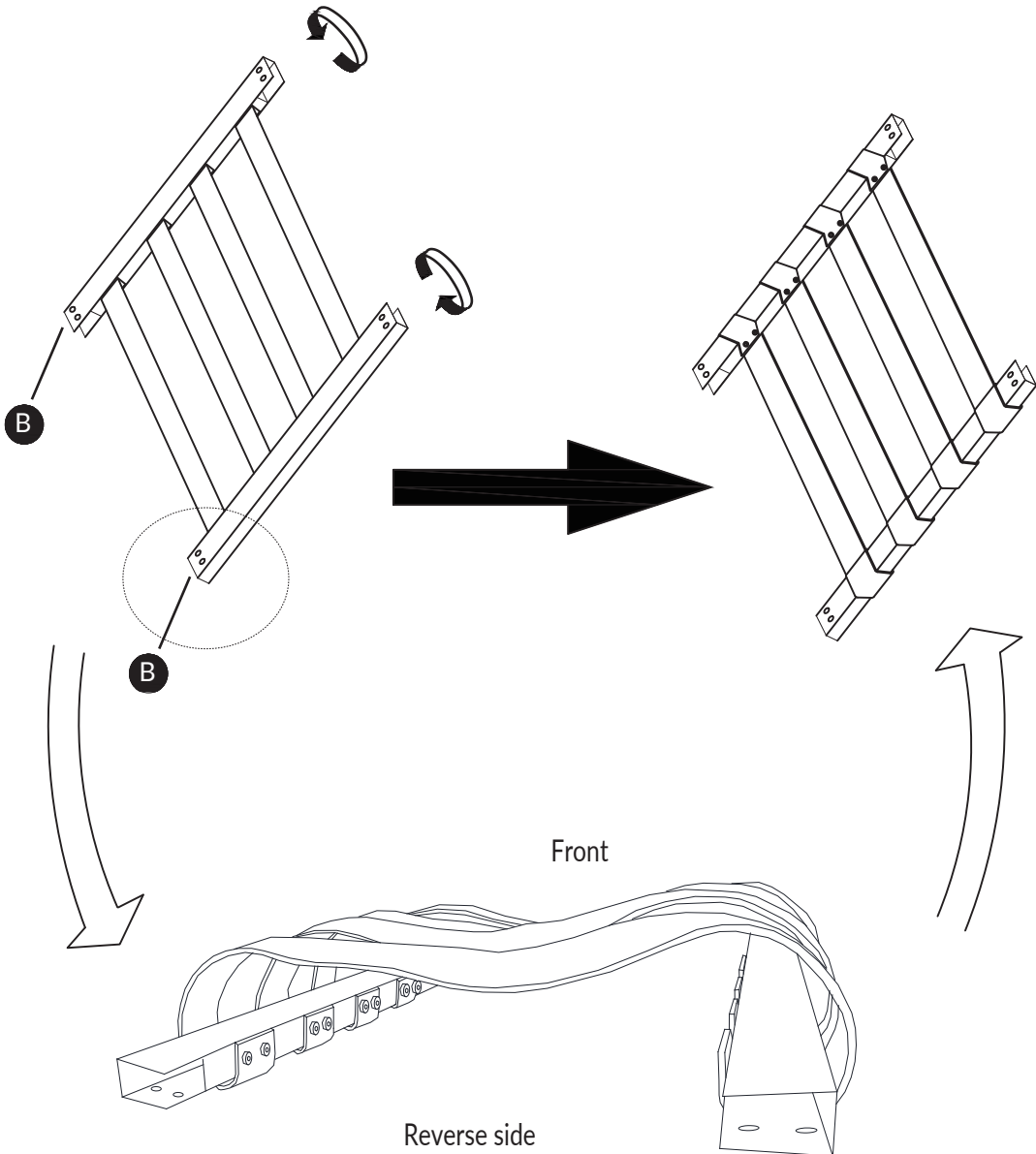

Step 2



The belt should come out from above the rod.

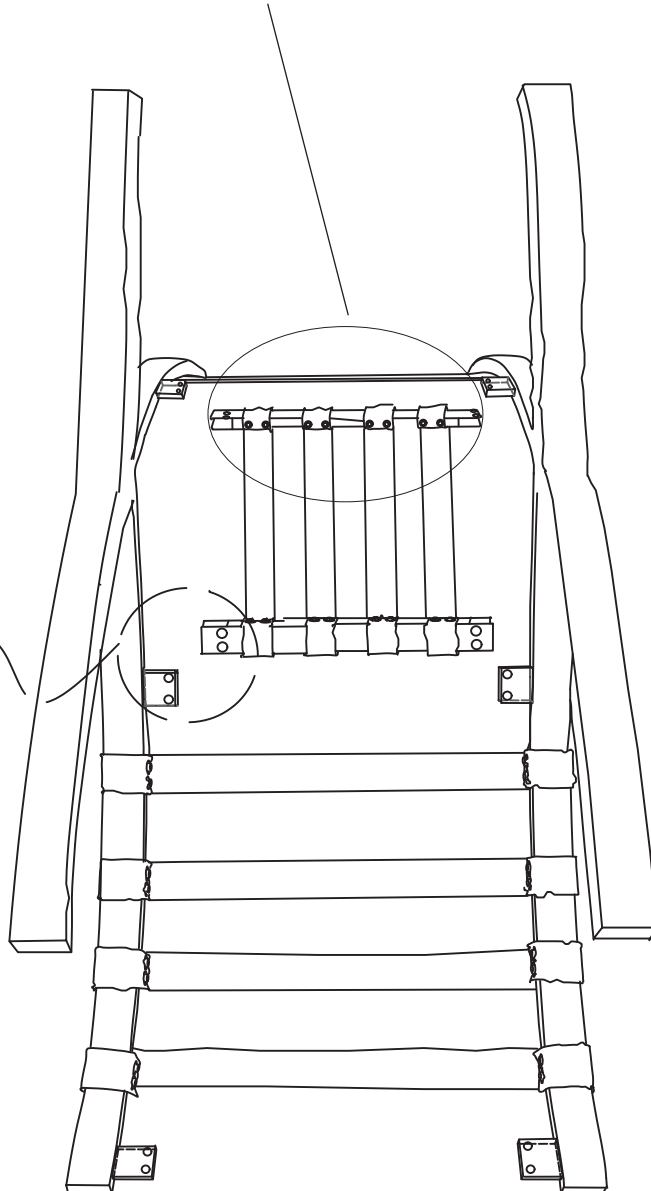
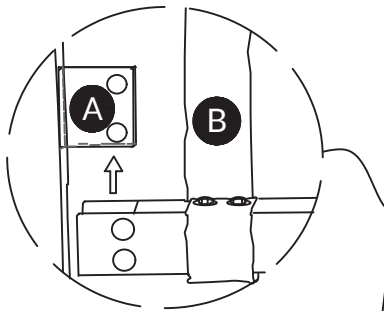

Do not fully tighten the bolts until the installation is completed.

Step 3

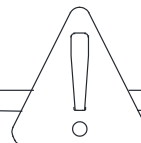
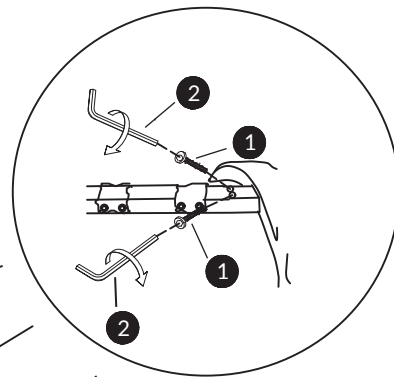
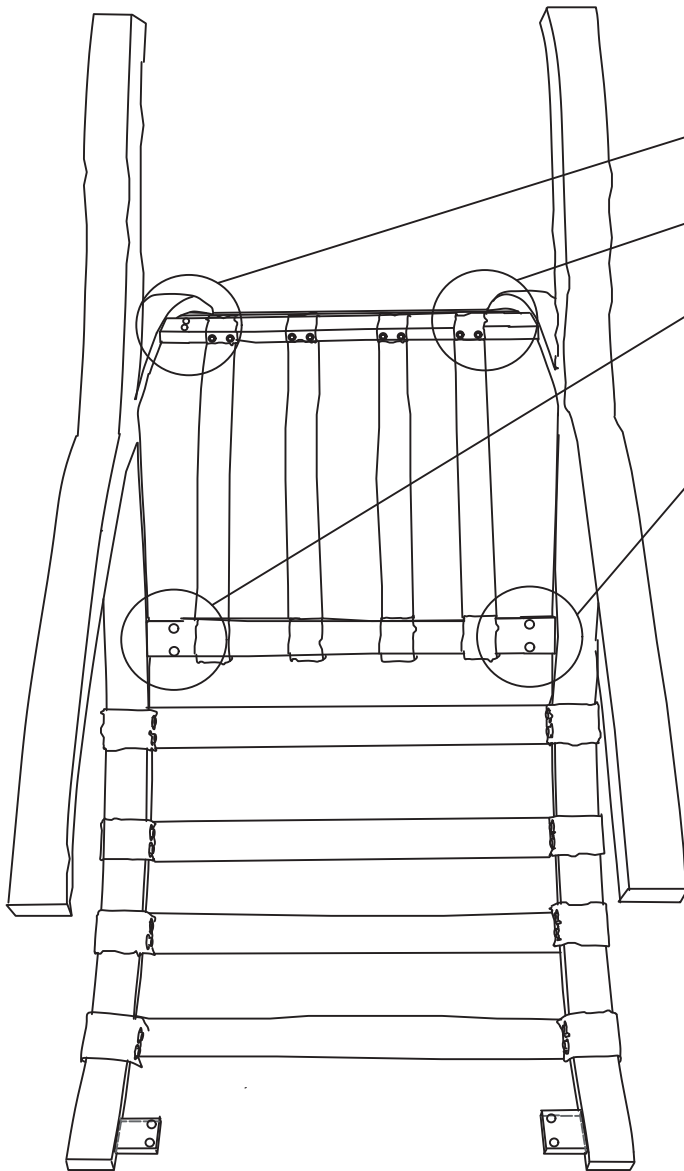

Do not fully tighten the bolts until the installation is completed.

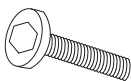
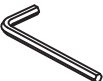
1	x16	2	x1
			
M6x16MM			

Step 4

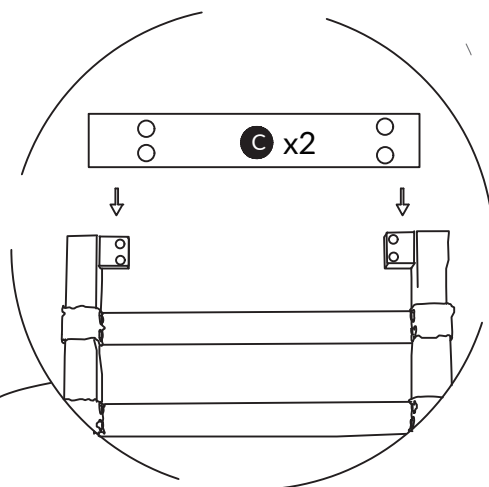
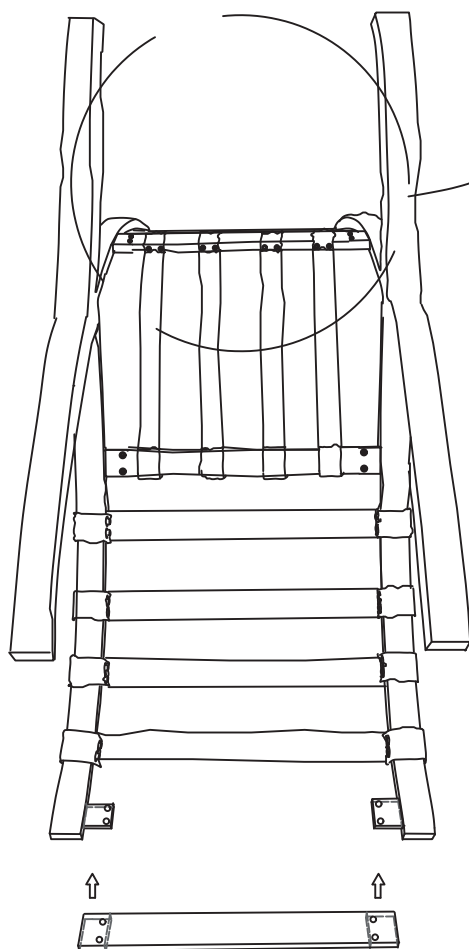

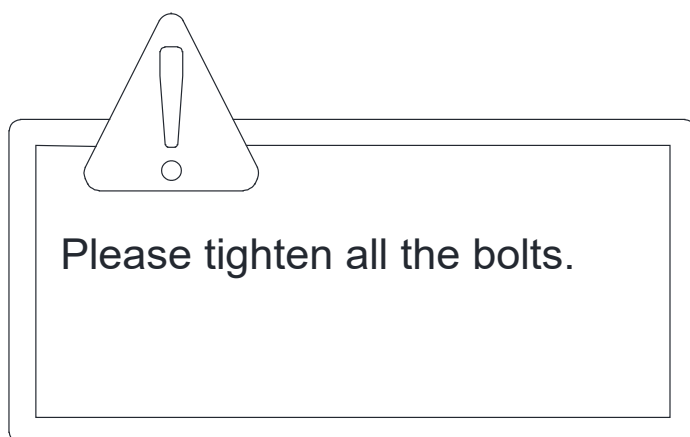
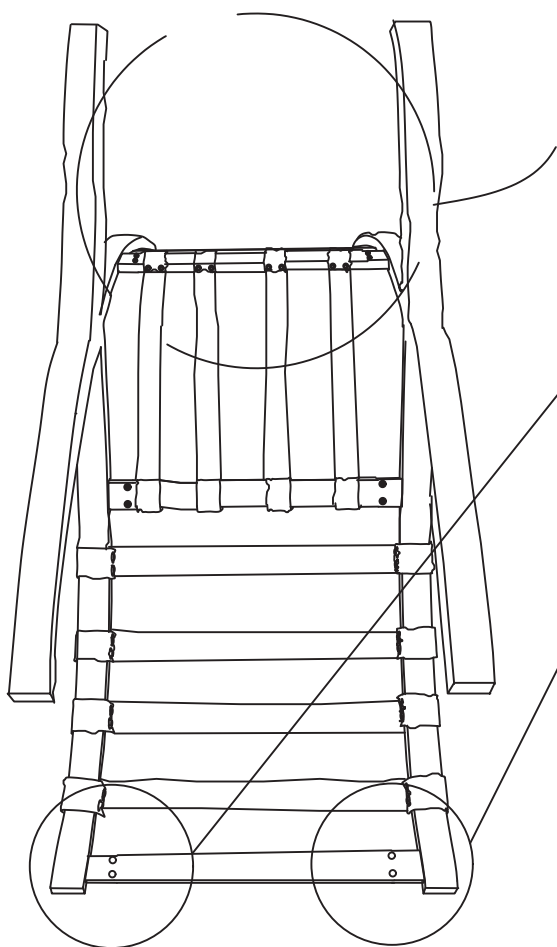
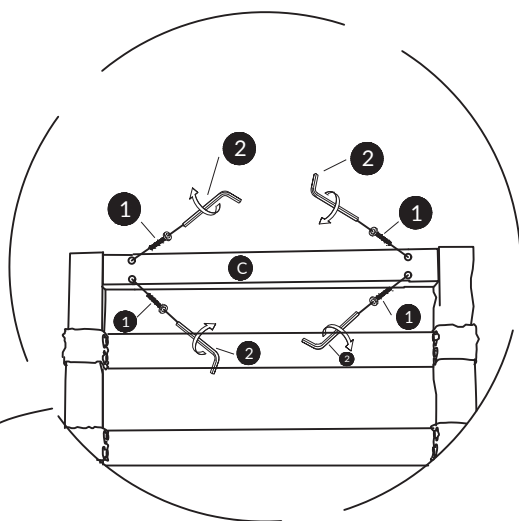

Do not fully tighten the bolts until the installation is completed.

Step 5

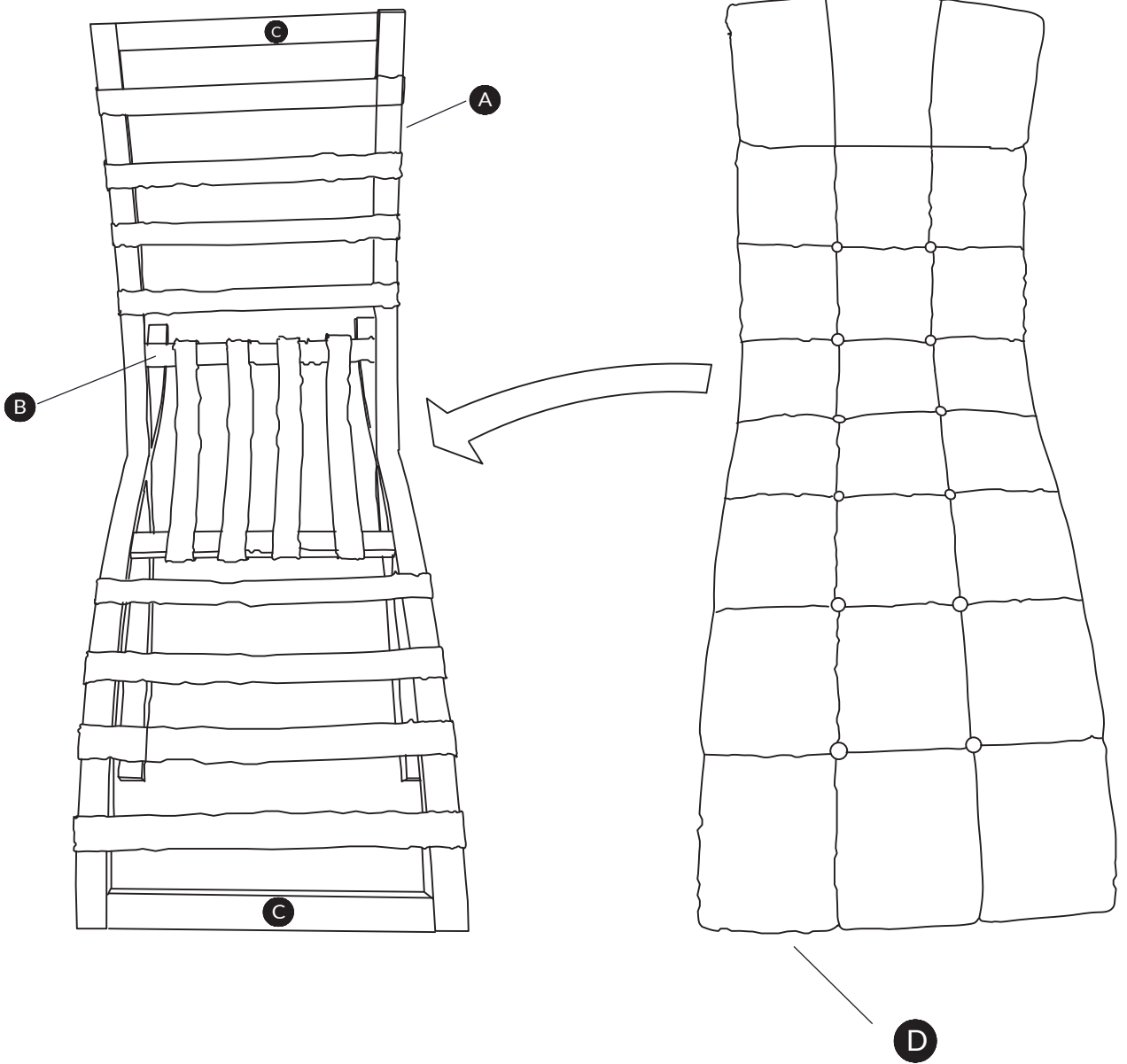

Step 6



Step 7

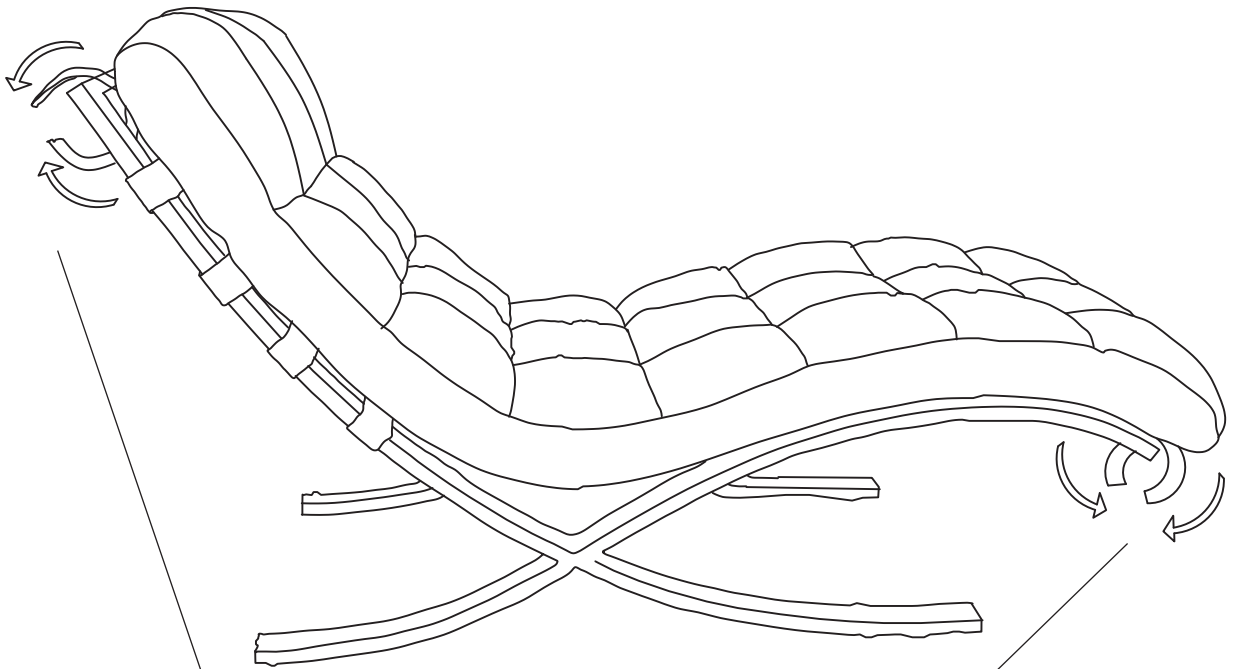

The straps under the seat cushion are tied to the frame.

Step 8

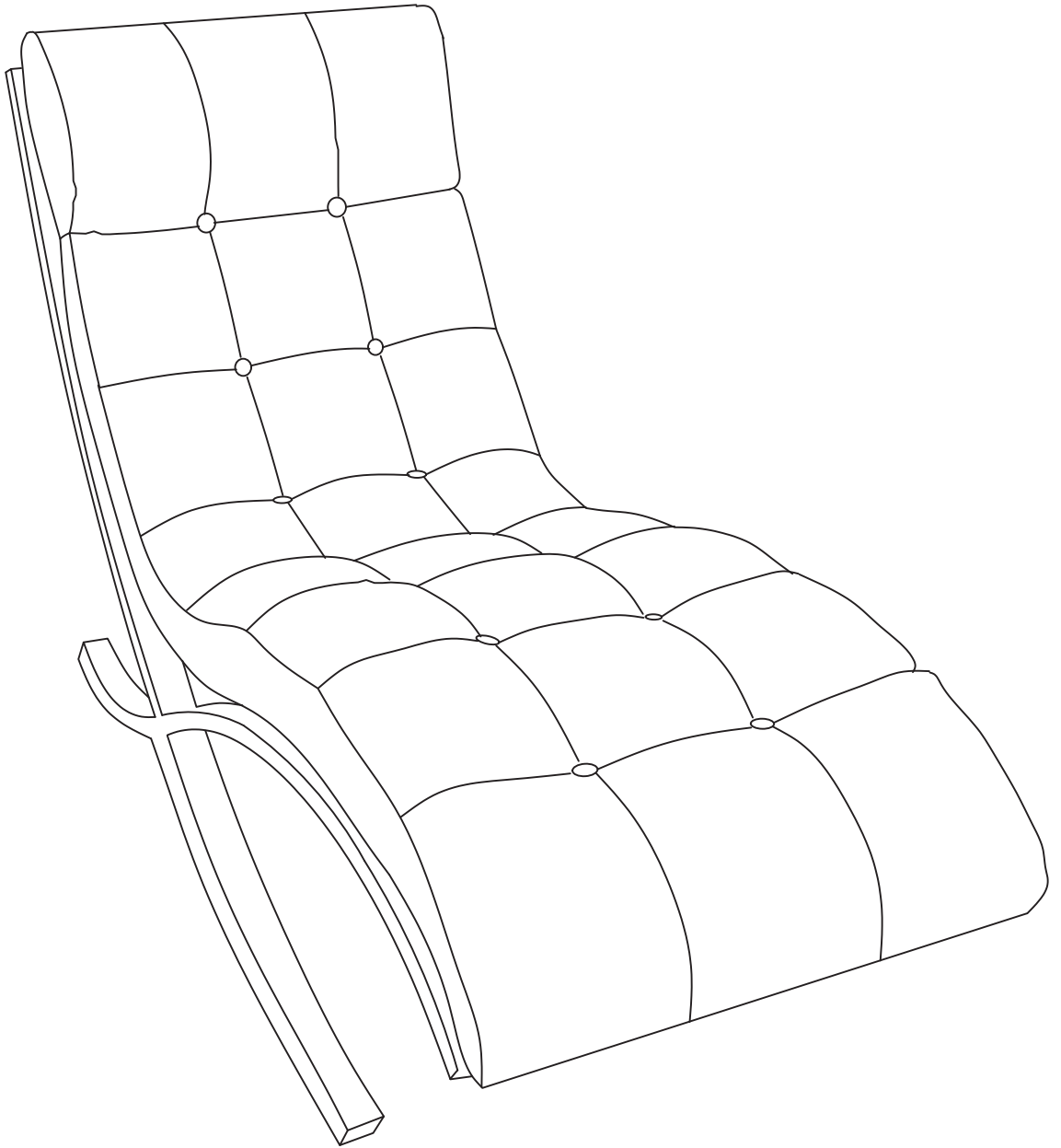

WARRANTY

- We strive to offer quality products, and we also try our best to satisfy every customer who orders from us with products or services as needed.
- We provide 30 days warranty starting from the time you receive the item. Each customer must provide a record of their orders such as the order number, or item receipt for any items that are out of the warranty period you may also still receive.
- Replacement parts by purchasing them from our company if they are available.
- For return, please check the return policy with the retailer or market place you bought