

TWIN / TWIN METAL BUNK BED

ITEM # 7540

ASSEMBLY INSTRUCTION



ITEM # 7540

IMPORTANT

For service purpose, please do not remove the customer service code label on the merchandise. It is on the underside of the bed.











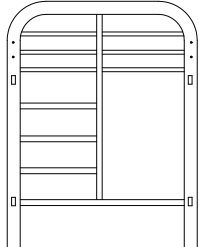

SAFETY PRECAUTION AND WARNING FOR BUNK BEDS

- A. Follow the information on the warnings appearing on the upper bunk end structure and on the carton, **“DO NOT REMOVE THIS LABEL”**
- B. Always use the recommended size mattress or mattress support, or both, to help prevent the likelihood of entrapment or falls. Use only mattress.
 - **TWIN—74"—75" × 37 ½"—38 ½"**
 - **FULL—74"—75" × 53"—54"**When centered mattress, must be no more than 1" at any point from the interior bed structure.
- C. Ensure thickness of mattress does not exceed 6", and surface of mattress must be at least 5" (127mm) below the upper edge of guardrails.
- D. **DO NOT** allow children under 6 years of age to use the upper bunk.
- E. Periodically check and ensure that the guardrails, ladder and other components are in their proper position, free from damage and make sure all connections are tighten properly.
- F. **DO NOT** allow horseplay on or under the bed and prohibit jumping on the bed.
- G. Always use the ladder for entering and leaving the upper bunk.
- H. **DO NOT** use substituted parts, Contact SELLER for replacement parts.
- I. Prohibit more than one person on upper bunk.
- J. Use a night light as an added safety precaution for a child using the upper bunk.
- K. Always use guardrails on both long sides of the upper bunk.
- L. The use of water or sleep floatation mattress is prohibited.
- M. **KEEP THESE INSTRUCTIONS FOR FUTURE REFERENCES.**

NOTE:



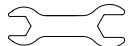
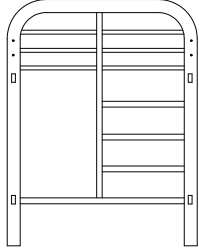
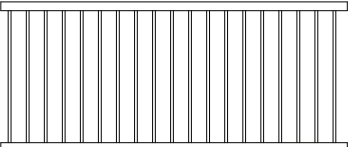
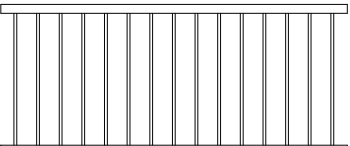
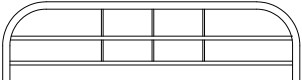

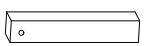
- This item not recommended for commercial use
- Keep this document for reference in case parts are needed
- Do not tighten all bolts until the bed is assembled completely
- Hardware pack attached in the package in red plastic bag.

ITEM # 7540

COMPONENTS IDENTIFICATION			
PART LIST		HARDWARE LIST	
(1)		1PC	(A)  5/16" × 80mm 8PCS (B)  5/16" × 35mm 5PCS (C)  1/4" × 12mm 8PCS (D)  NUT 5/16" 13PCS (E)  SPECIAL WASHER 8PCS (F)  WASHER 6PCS (G)  5MM WRENCH 1PC (H)  4MM WRENCH 1PC (I)  WRENCH 1PC
(2)		1PC	
(3)		1PC	
(4)		1PC	
(5)		2PCS	
(6)		4PCS	
(7)		1PC	
(8)		1PC	

ITEM # 7540

STEP 1.

-  (B) x 4
-  (C) x 4
-  (D) x 4
-  (F) x 4

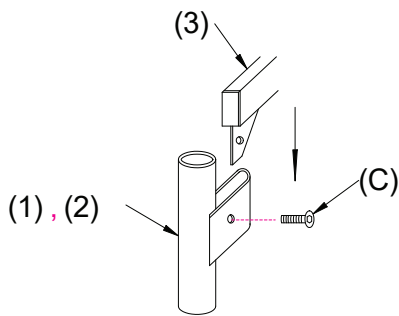
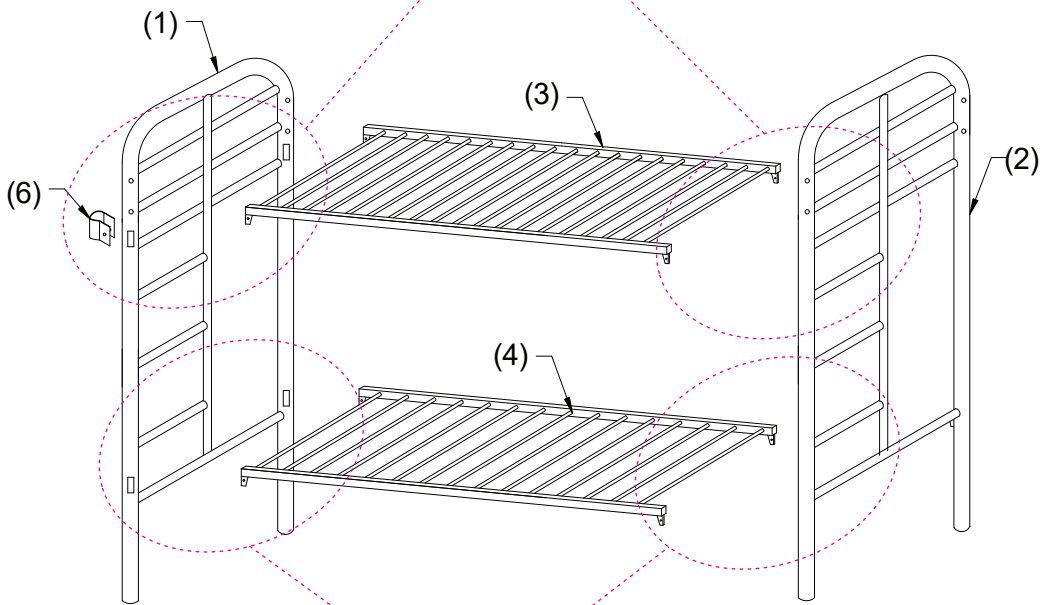
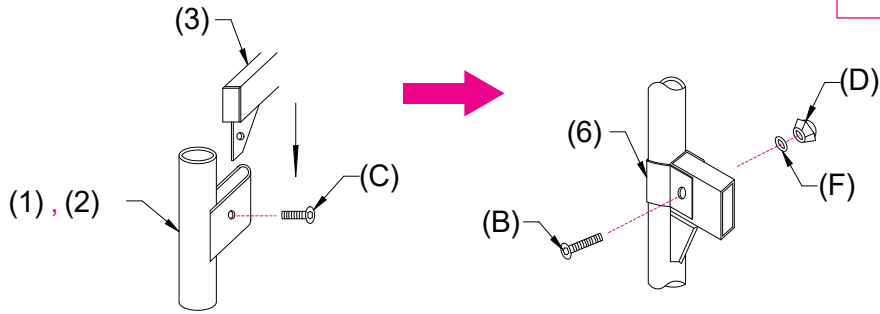

-  (C) x 4

ITEM # 7540

STEP 2.

- (A) x 8
- (D) x 8
- (E) x 8

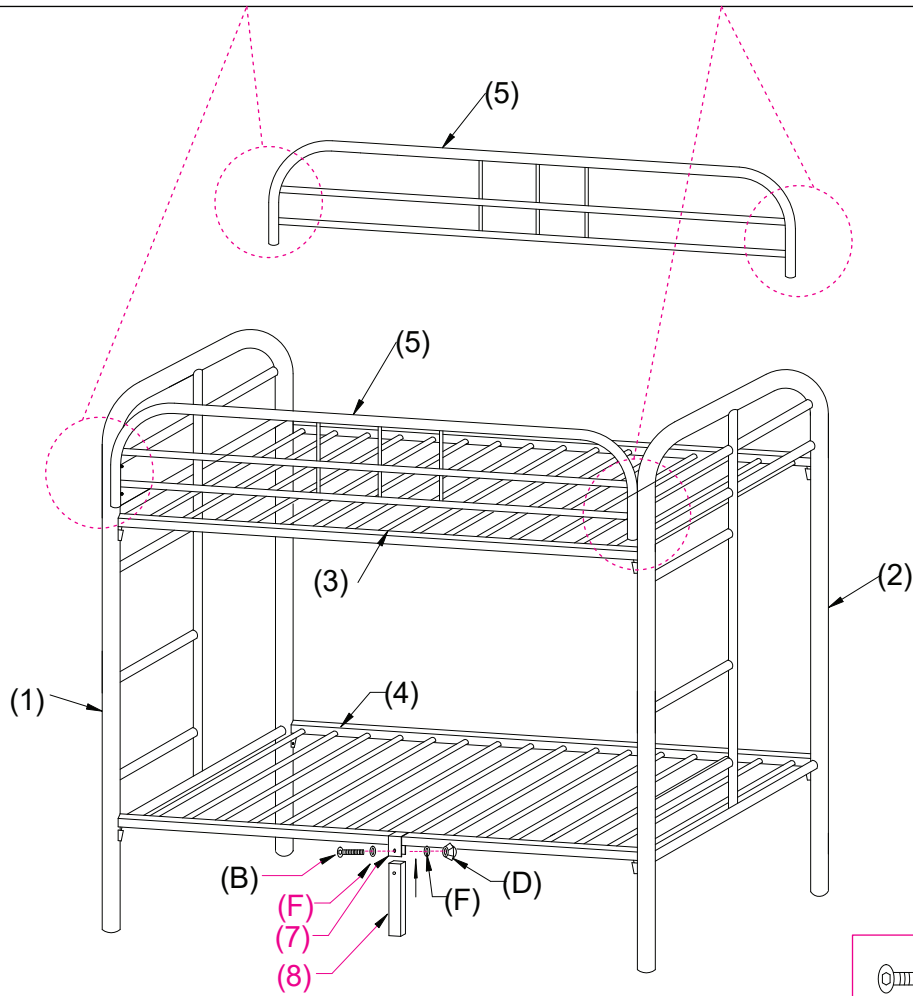
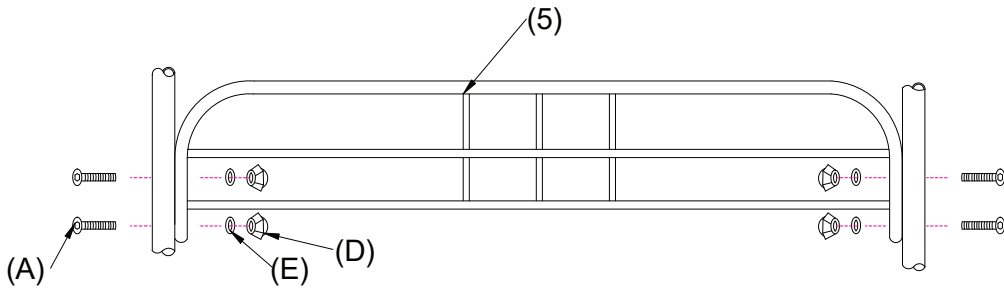

- (B) x 1
- (D) x 1
- (F) x 2

ITEM # 7540

STEP 3.

Your bed is now ready!

Make sure all screws and bolts are fully tightened before using.

DO NOT Jump or Stand on top!

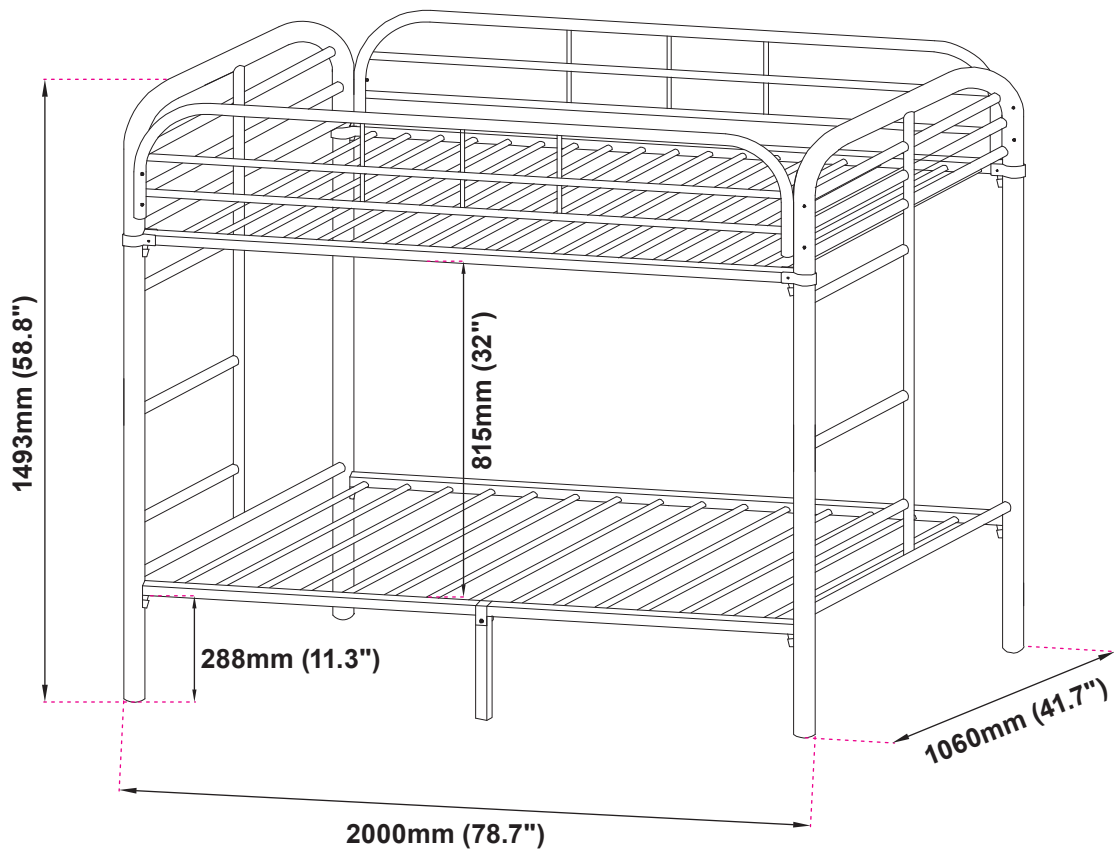

ASSEMBLY COMPLETED