

## Features

- Minimum 30-inch base cabinet width.
- Single bowl.
- 9-1/2-inch depth.
- No faucet holes.
- Includes K-80038 bottom sink rack.
- Includes cutout templates and installation clips.

## Material

- KOHLER Neoroc® composite is durable and built to withstand day-to-day cleaning tasks.
- Matte finish offers rich, dimensional color.
- Solid color throughout the sink.
- Heat resistant up to 750 degrees F.
- Scratch, stain, chip, and thermal-shock resistant.

## Installation

- Under-mount
- Easy to install in a one-person, single-day project.

## Recommended Products/Accessories

K-9000 P-Trap  
K-8801 Sink Strainer  
K-8799 Sink Strainer

## Included Components

Product consists of:  
K-80038 Sink Rack



## Codes/Standards







CSA B45.5/IAPMO Z124

## KOHLER® Neoroc® Sinks Lifetime Limited Warranty

See website for detailed warranty information.

## Available Colors/Finishes

*Color tiles intended for reference only.*

Color	Code	Description
	CM6	Matte White
	CM7	Matte Graphite
	CM5	Matte Beige
	CM1	Matte Black
	CM2	Matte Brown
	CM3	Matte Toupe
	CM4	Matte Grey

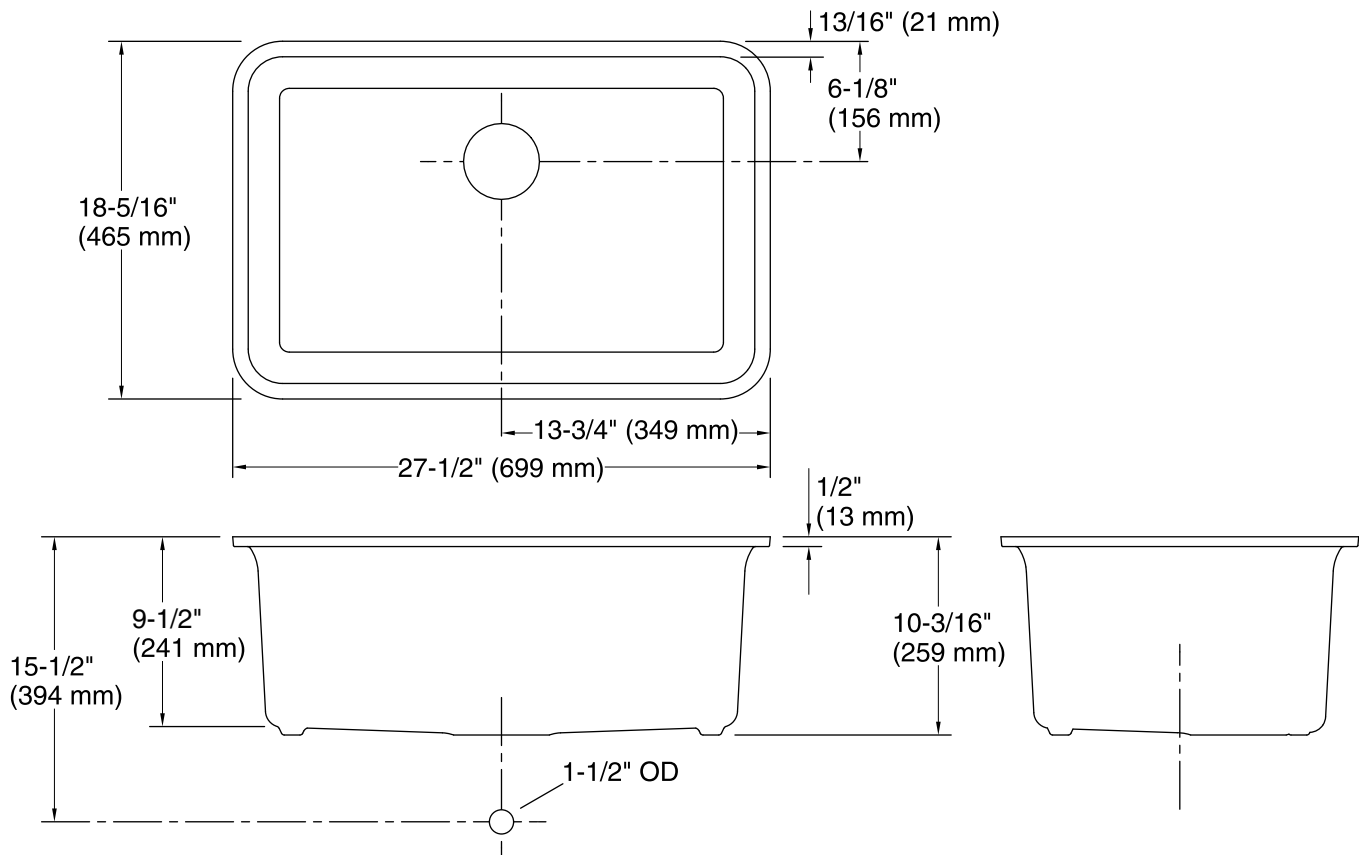

## Technical Information

All product dimensions are nominal.

Installation:	Under-mount
Min. base cabinet width:	30" (762 mm)
Bowl area (Only):	Length: 25-9/16" (649 mm) Width: 16-3/8" (416 mm) Bowl depth: 9-1/2" (241 mm) Water depth: 9-1/2" (241 mm)
Template:	Under-mount, 1311528, required, included

## Notes

Install this product according to the installation instructions.

Countertop manufacturer or cutter must use the cut-out template provided with the product, or a current one provided by Kohler Co. (call 1-800-43-FOCUS). Kohler Co. is not responsible for cut-out errors when the incorrect cut-out template is used.