

Contact Us!

Do NOT return this item.

Contact our friendly customer service department for help first.



Before You Start

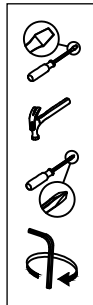

- ① Read each step carefully before starting. It is very important to ensure each step followed in correct order, otherwise assembly difficulties may occur.
- ② Most of board parts are labeled or stamped on the raw edges. Have a check to make sure all parts are included.
- ③ Work in a spacious area, preferably on a carpet close to where the unit will be used.
- ④ Keep the handtools close at hand. Do not use power tools to assemble your furniture. They may scratch or damage the parts.

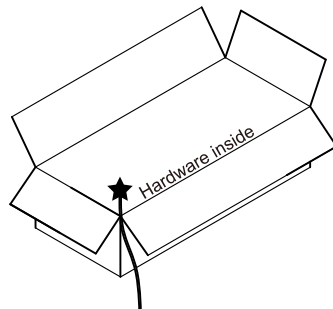

Board Identification

Not actual size

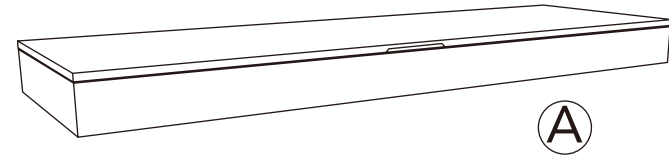

Cabinet x1

Hardware List

Actual size

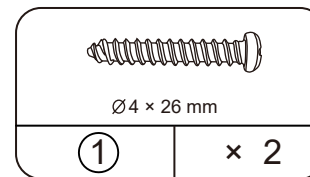

SELF TAPPING SCREW

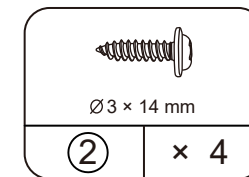

SCREW

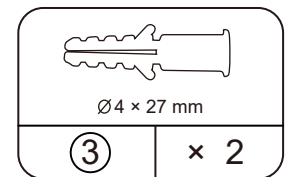

EXPANSION SCREW

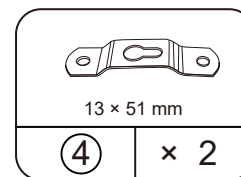

HANGING HOOK

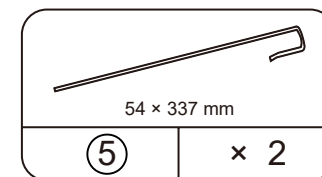

HOOK

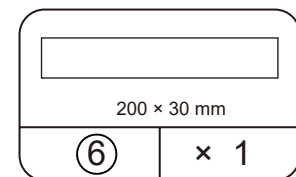

DOUBLE SIDED TAPE

PRODUCT ASSEMBLY

Wall mount

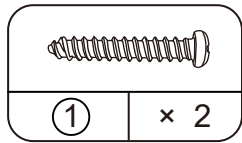

SELF TAPPING SCREW

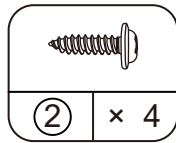

SCREW

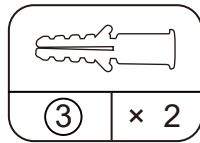

EXPANSION PIPE

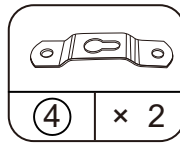

HANGING PANEL

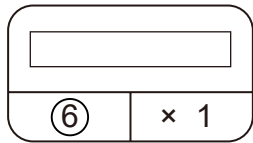

DOUBLE SIDED TAPE

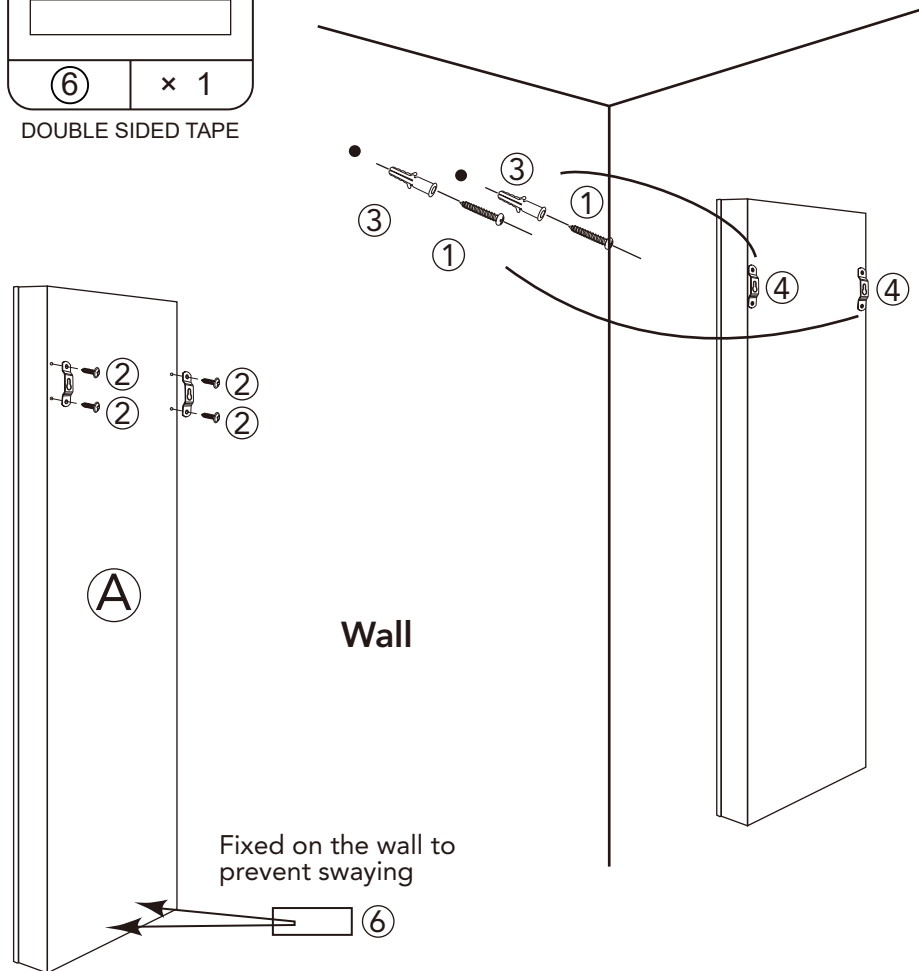

PRODUCT ASSEMBLY

Hand over the door

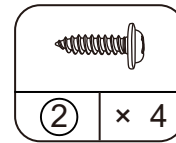

SCREW

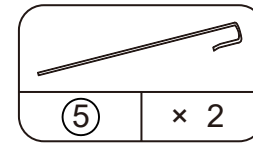

HOOK

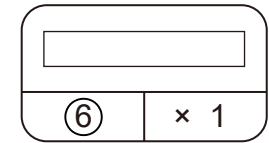

DOUBLE SIDED TAPE

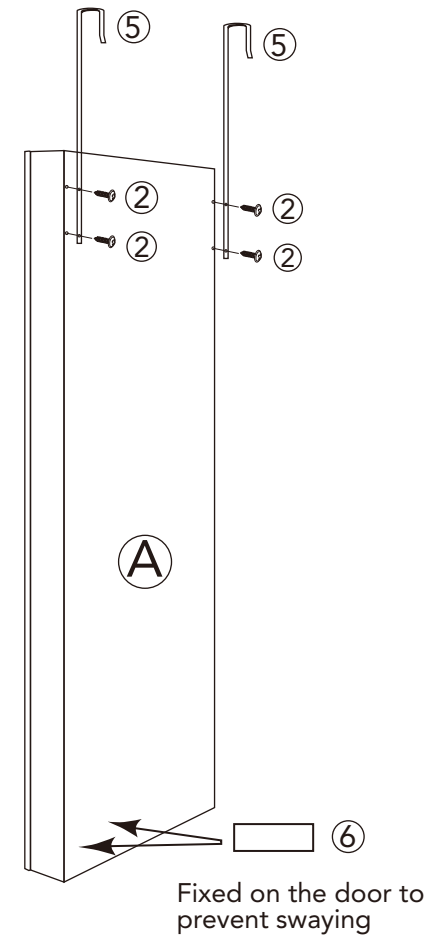

Wall mount

Hand over the door

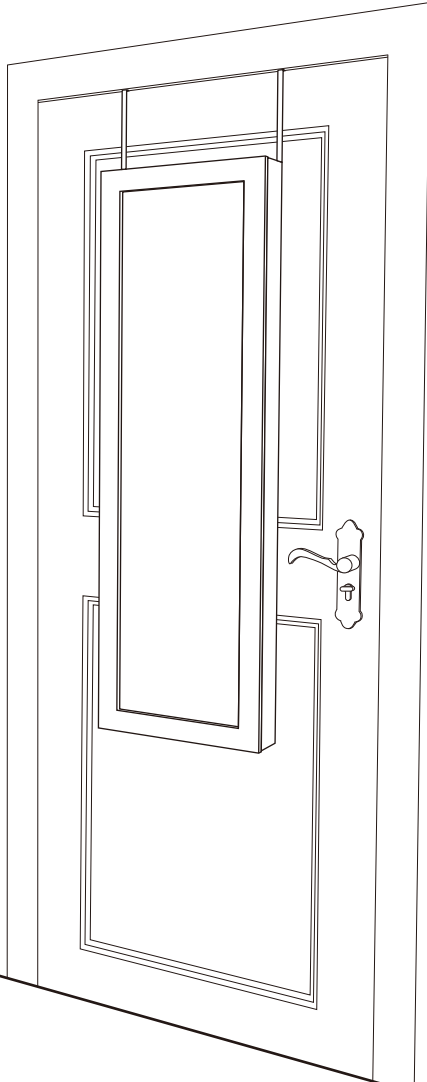
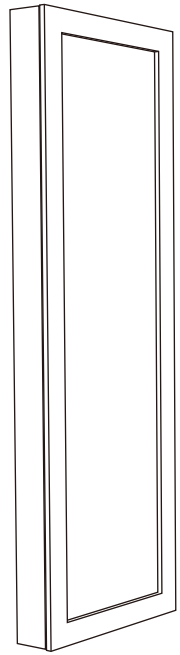

Maximum Loads

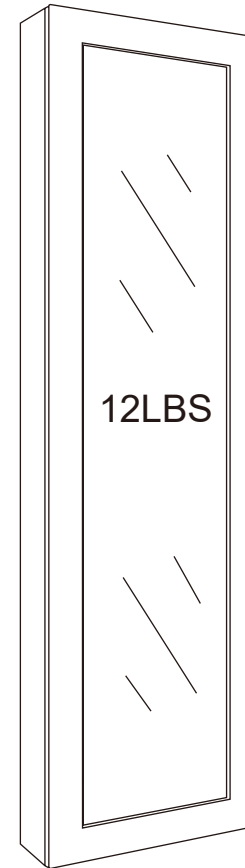

⚠ WARNING

This item is only suitable within the specified maximum load-bearing. Heavier loads than the indicated load capacity may cause instability, resulting in possible injuries.