

Top View

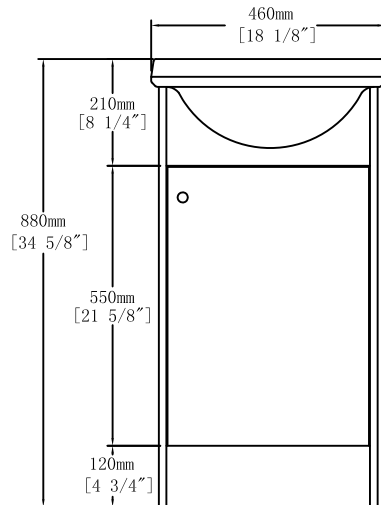

Front View

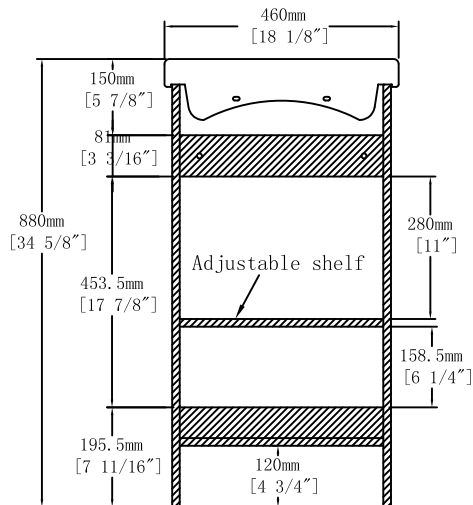

Back View

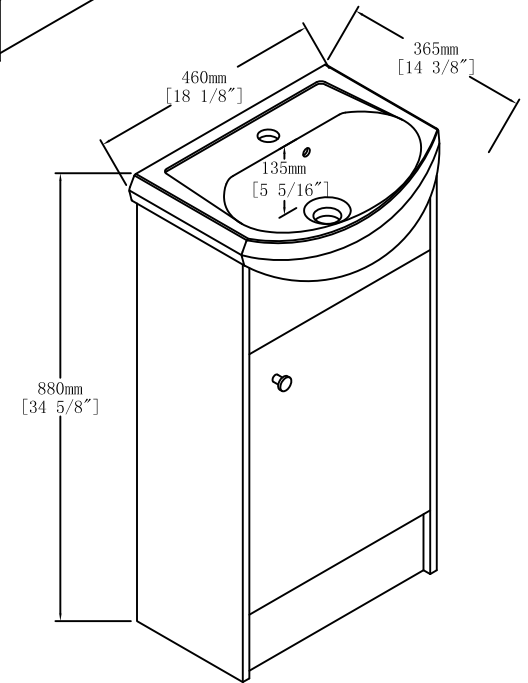
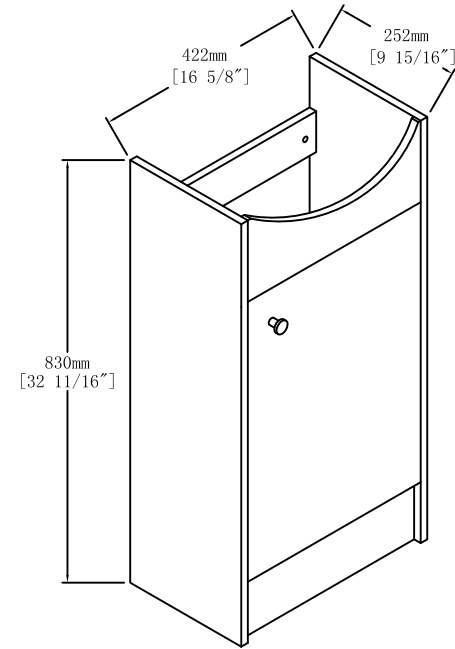

Item NO.	BV B02218	Version	V1
Projece		Date	2022-8-6