

# ULTRA FAUCETS

## INSTRUCTION

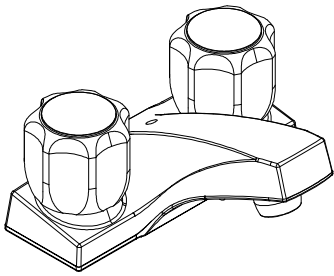

Two Handle Lavatory Faucet  
Model no: UF4423X and UF4420X

### Tools:

- Adjustable Wrench
- Pliers
- Pipe Wrench
- Screwdriver
- Teflon Tape



### Maintenance:

Your new Lavatory faucet is designed for years of trouble-free performance.

Keep it looking new by cleaning it periodically with a soft cloth. Avoid abrasive cleaners, steel wool and harsh chemicals as these will dull the finish and void your warranty.

### Preparation / Assembly

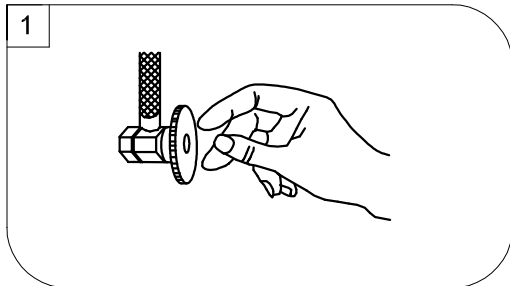

Shut off water supplies. Remove old faucet. Clean sink surface in preparation for new faucet.

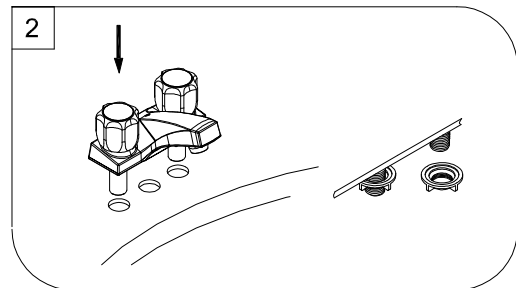

Place new faucet in position on the sink. From under sink, threads mounting nuts onto faucet. Tighten mounting nuts.

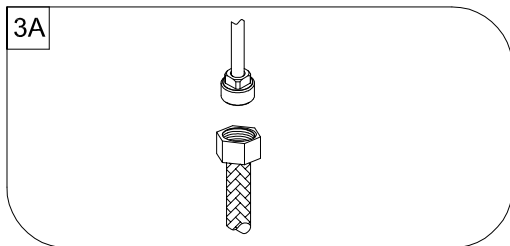

(A) Stainless Steel Braided Faucet Supply Tubes: This is the simplest of all installations. If you are using stainless steel braided faucet supply tubes, this faucet requires one end of the supply tube to have a 1/2" female IPS connection. The other end of this supply tube must match the thread on the water supply fittings or shut off valve under your sink. Once you have identified the required tube, carefully follow the manufacturer's installation instructions for each tube

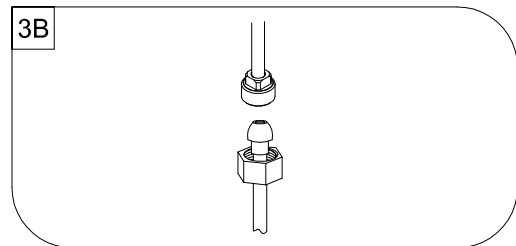

(B) Ball Nose Flexible Supplies: If you are using ball-nose flexible supplies to connect the faucet to water supply lines: Slip coupling nut behind ball-nose of flexible supply lines: Slip coupling nut behind ball-nose of flexible supply tube. Ball nose coupling will go partially into IPS shank or fitting. Tighten coupling nut (DO NOT OVER TIGHTEN). Install opposite end according to manufacturer's instructions for both tubes.

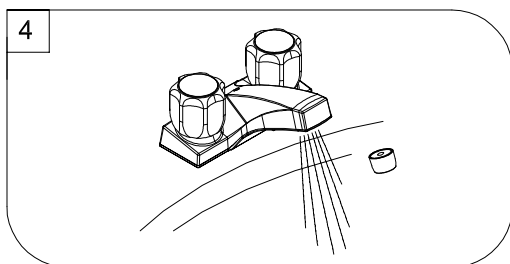

Remove AERATOR and turn faucet handle all the way on. Turn on hot and cold water supplies and flush water lines for one minute. Check all connections for leaks. Re-tighten if necessary, but do not overtighten. Reinstall AERATOR. Your new faucet is ready to use.

Exploded Drawing  
RP(Replacement Parts)

---

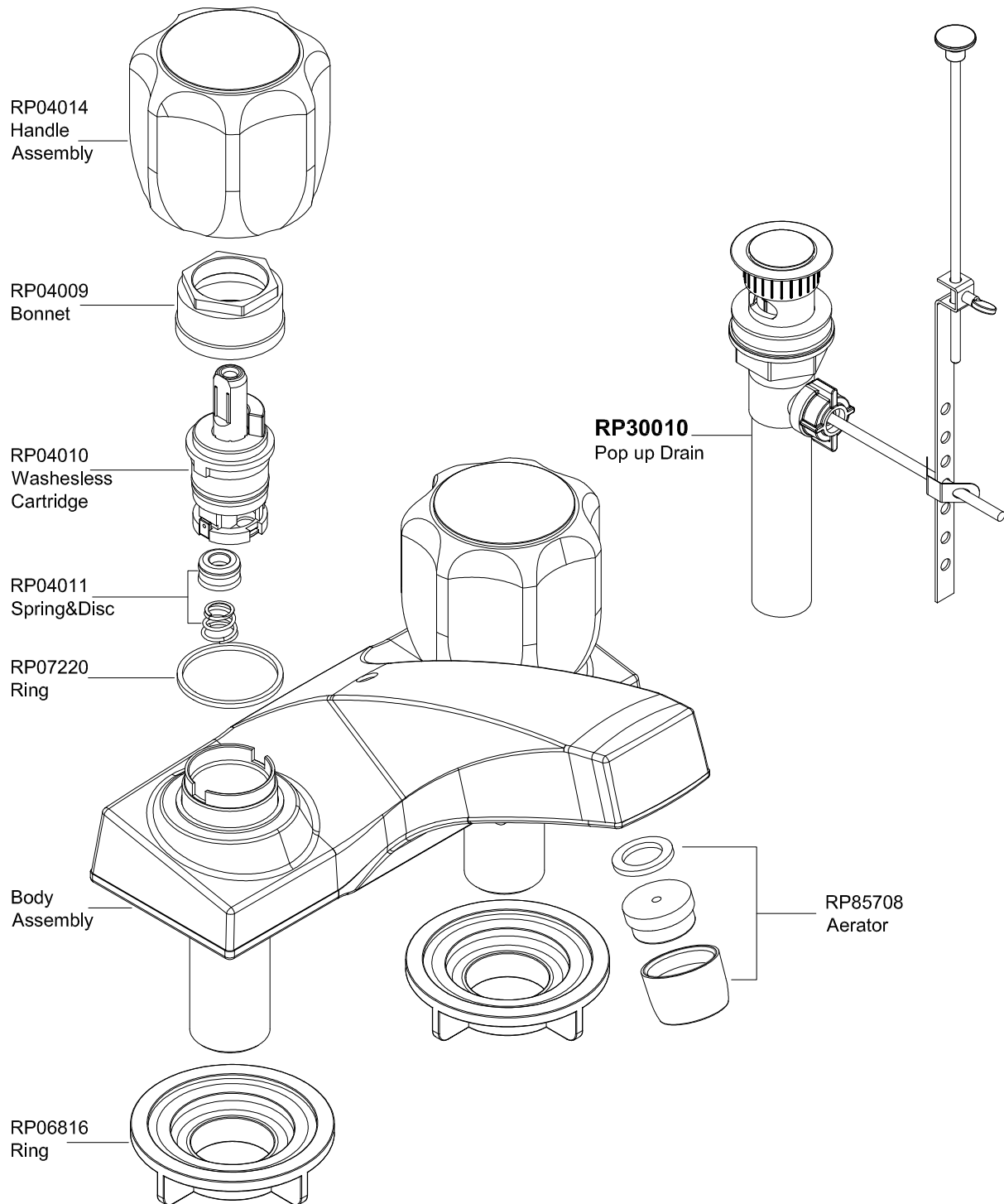

### Limited Lifetime Warranty

Ultra Faucets warrants to the original purchaser that its products will be free from defects in workmanship and materials. All Ultra Faucets are provided with a life time limited warranty. This warranty does not cover any other labor or service charges associated with the removal, repair, or reinstallation of Ultra Faucets products. This express warranty does not apply to products that have been damaged as a result of misuse, abuse, negligence, accident, faulty installation or maintenance practices and/or used in any manner contrary to those recommended by the manufacturer.