

ASSEMBLY INSTRUCTION

Friendly Reminder:

- 1.This sofa is packed in 3 boxes. Please assemble it After all boxes are received.
- 2.As the cushions are all vacuum compressed,there will be some wrinkles. Please give your cushions up to 72 hours to reach its original size and the wrinkles will basically disappear.
- 3.Please do not open the compressed packags until your sofa frame is completely assembled.

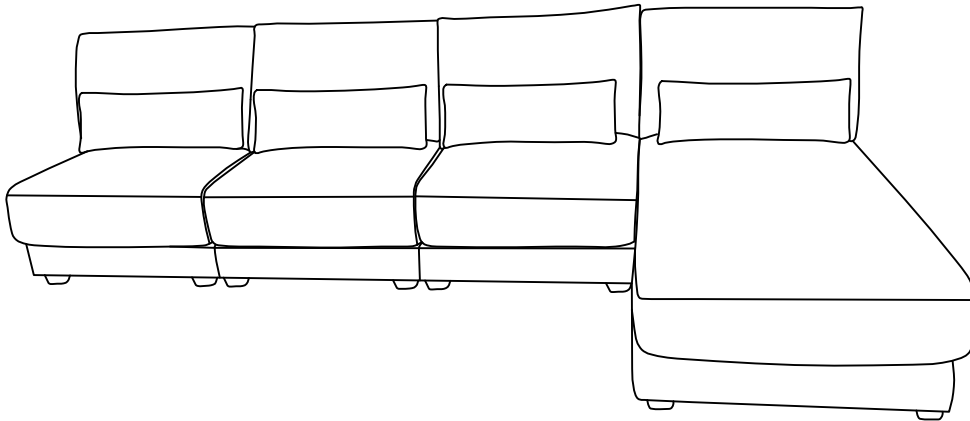





Return & Warranty policy:



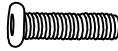
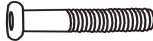

- We strive to offer the highest quality products,and we also try our best to satisfy each and every customer that orders from us with replacement parts or service as needed.
- If the item is damaged or defective, please take photos as evidence for replacements and refunds.
- Please do not return to store,contact the seller if you have any troubles with this product.

ASSEMBLY INSTRUCTION

HARDWARE

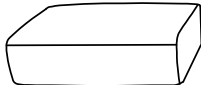
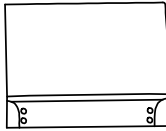

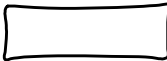
NO	DESCRIPTION	SKETCH	QTY
1	Gasket		16
2	Washer		28
3	Screws 8X60		16
4	Screws 8X80		6
5	Butterfly nut		6
6	Wrench		1

PARTS LIST

NO	DESCRIPTION	SKETCH	QTY
B	Seat frame		1
D	Seat cushion		1
E	Back frame		2
G	Back cushion		1
H	Pillow		2
O	Leg		16

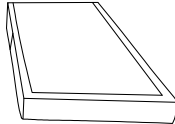
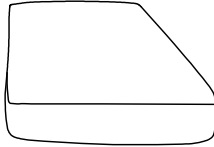
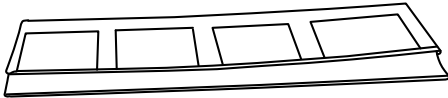

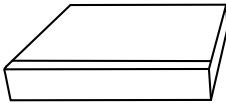

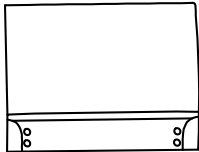
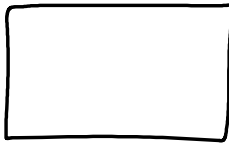
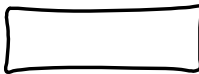
ASSEMBLY INSTRUCTION

PARTS LIST			
NO	DESCRIPTION	SKETCH	QTY
A	Chaise frame		1
C	Chaise cushion		1
F	Back cover		1

PARTS LIST			
NO	DESCRIPTION	SKETCH	QTY
B	Seat frame		2
D	Seat cushion		2
E	Back frame		2
G	Back cushion		3
H	Pillow		2

ASSEMBLY INSTRUCTION

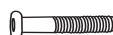
All parts and hardwares.

1		Gasket	16
2		Washer	28
3		Screws 8X60	16
4		Screws 8X80	6
5		Butterfly nut	6
6		Wrench	1

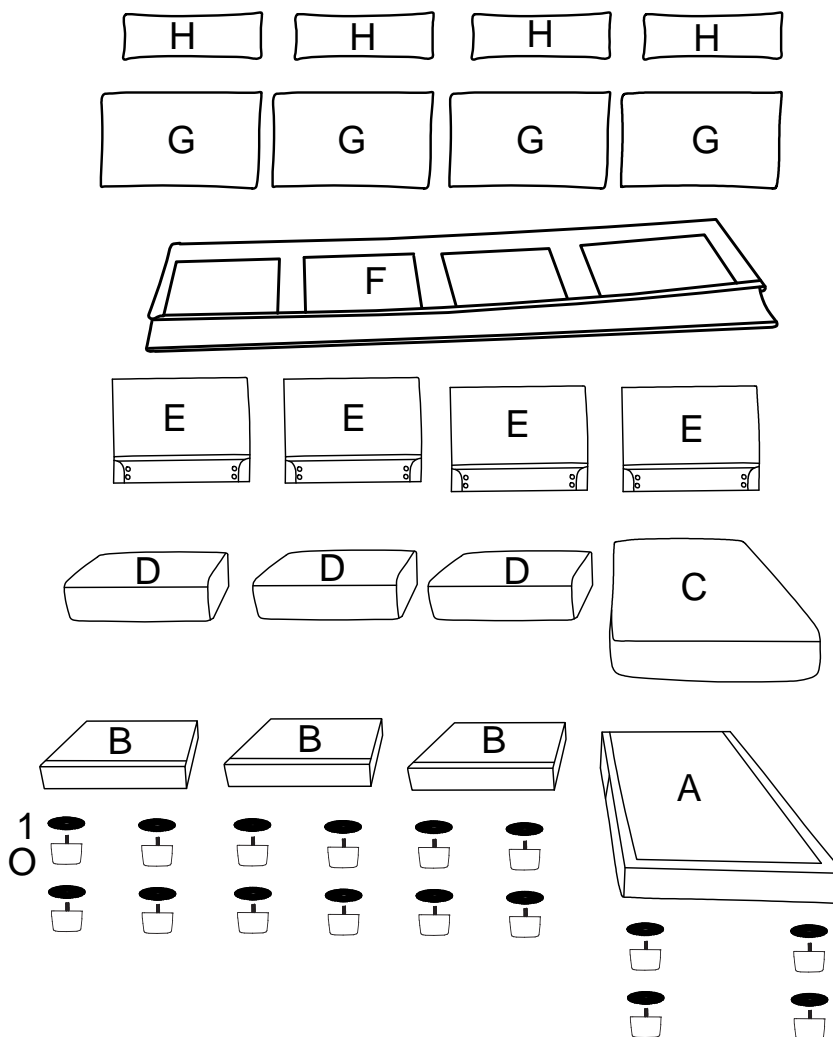

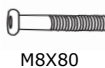



DIAGRAM 1 (Assemble the Seat frames)

Assemble the Chaise frame (Part A) and Seat frames (Part B) with Washers (Hardware 2), Screws (Hardware 4) and Butterfly nut (Hardware 5) by Wrench (Hardware 6).

2		12PCS
4	 M8X80	6PCS
5		6PCS
6		1PC

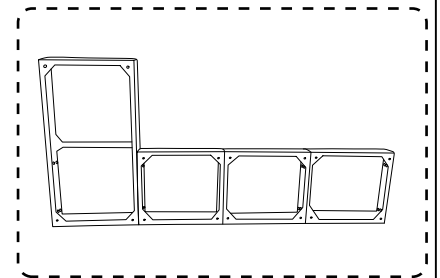
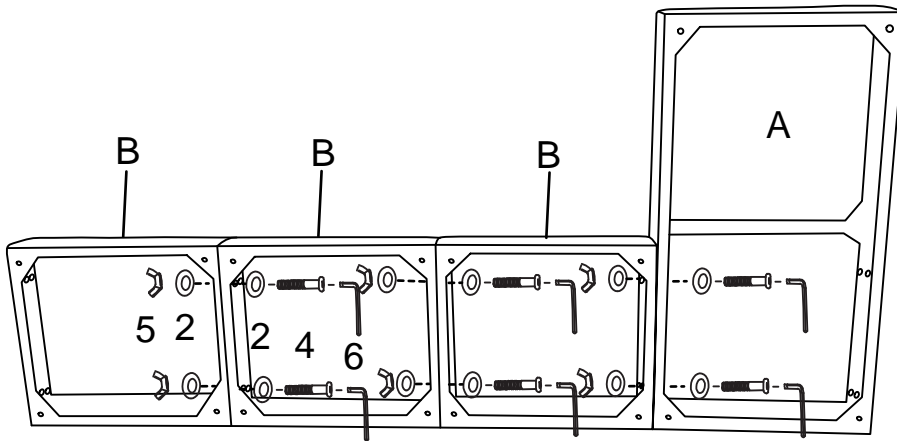



DIAGRAM 2 (Assemble the legs)

Assemble the Legs (Part O) on the Chaise frame (Part A) and Seat frame (Part B) with the Gaskets (Hardware 1).

1		16PCS
O		16PCS

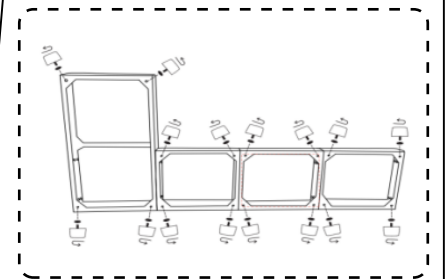
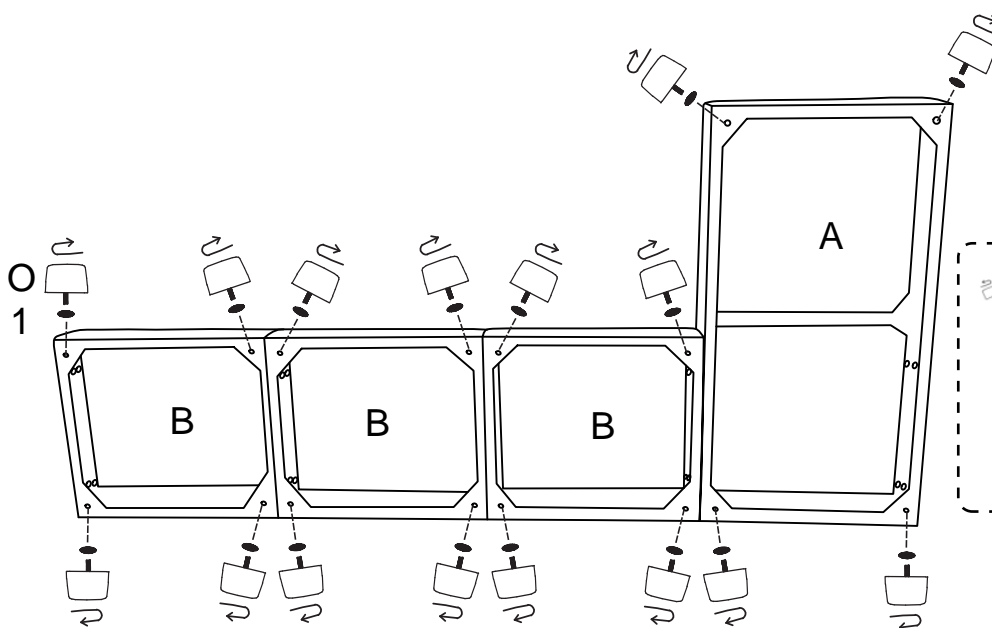



DIAGRAM 3 (Assemble the Back frame)

2		16PCS
3	 M8X60	16PCS

Place the washers (Hardware 2) and screws (Hardware 3) into the designated holes on the backrest, turn them to 70% by the wrench, and tighten all screws after it is fully installed.

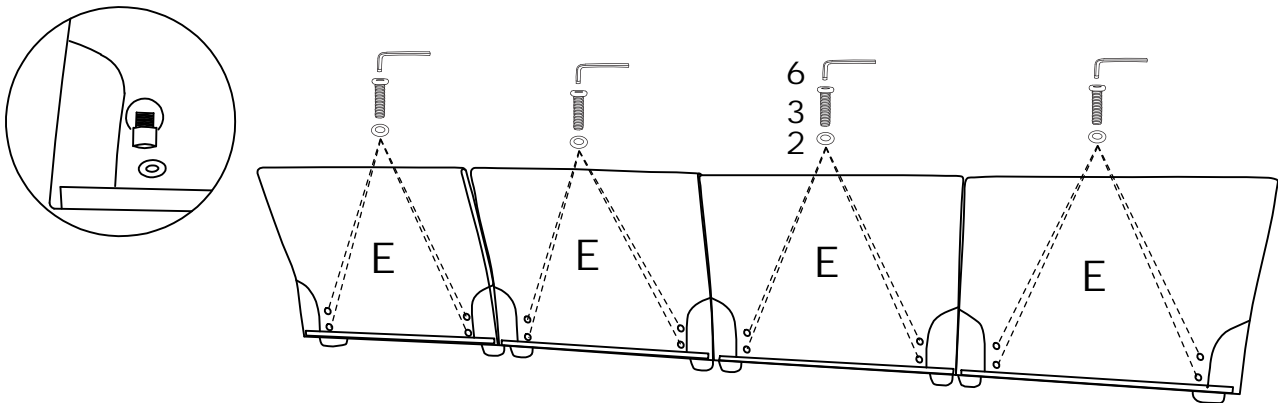

DIAGRAM 4 (Put the Back cover on the Back frame)

Place the Back cover (Parts F) on the Back frame.

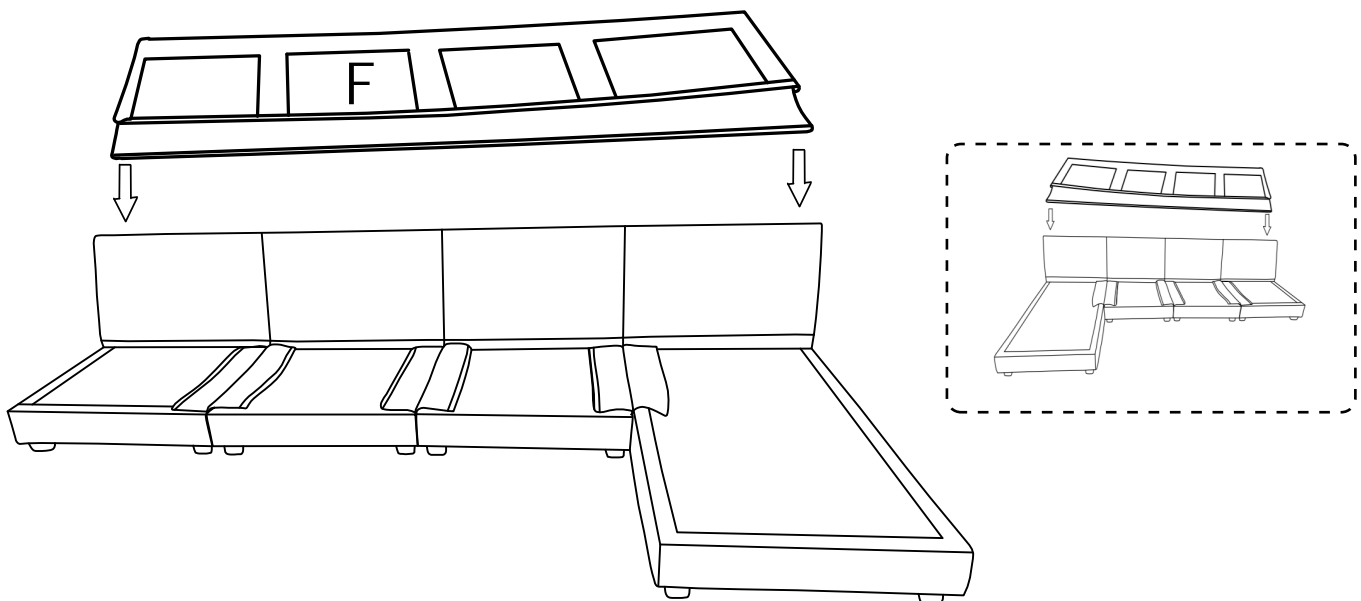
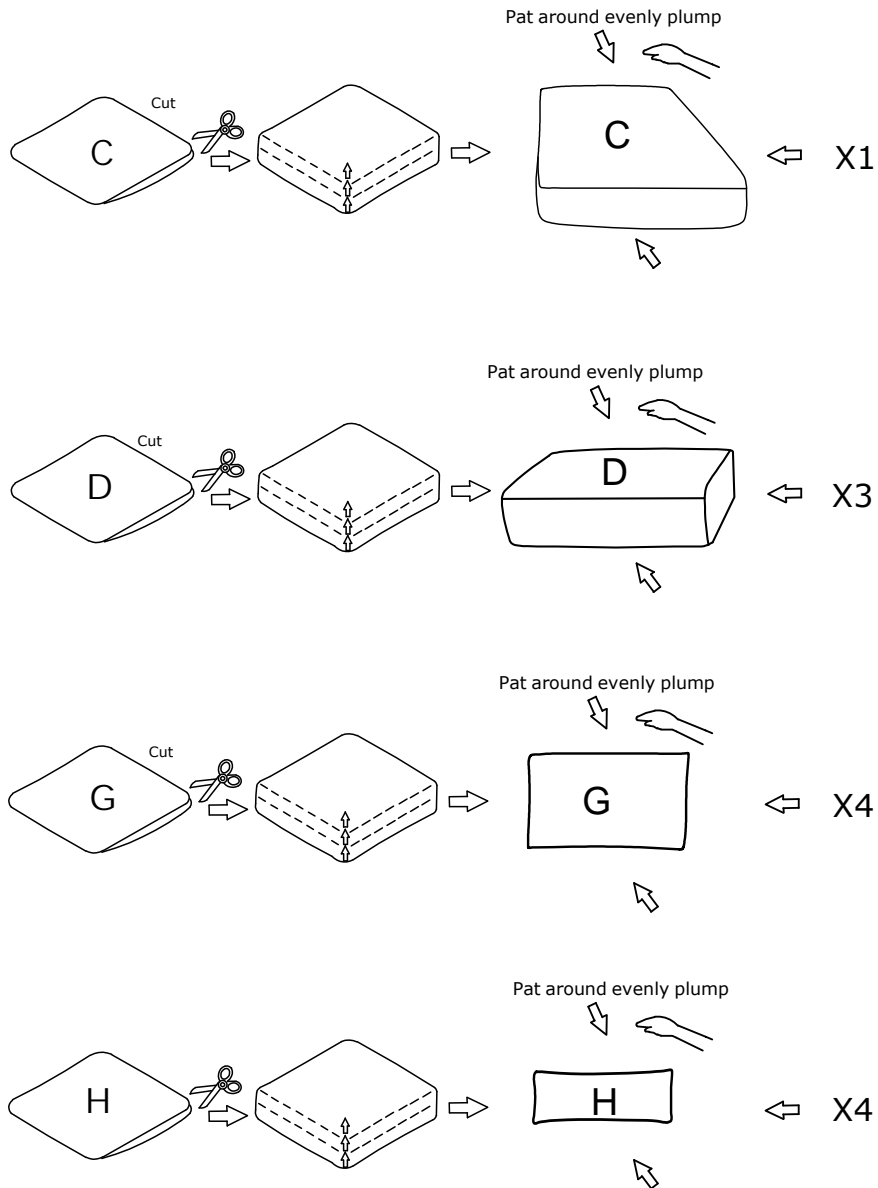

DIAGRAM 5 (Removal of compression bags)

Remove the Chaise cushion (Part C), Seat cushions (Part D), Back cushions (Part G) and Pillows (Part H).



TIPS

1. Please do not open the compressed packages until your sofa frame is completely assembled.
2. Compressed back cushions and pillows need to be fully fulfilled within 72 hours for your perfect use.
3. Please keep children away from plastic bags or any small pieces of stuff.

DIAGRAM 6 (Place the Cushion on the sofa)

Place the Chaise cushion (Part C) and Seat cushions (Part D) on the sofa.

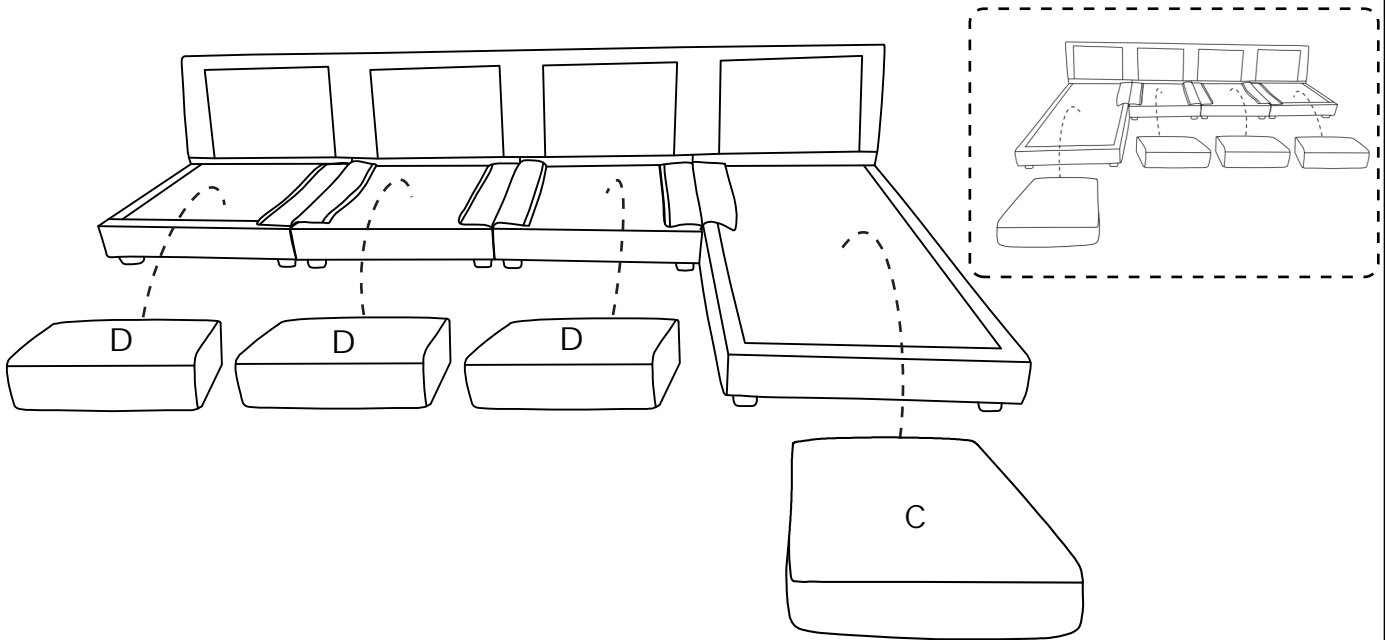
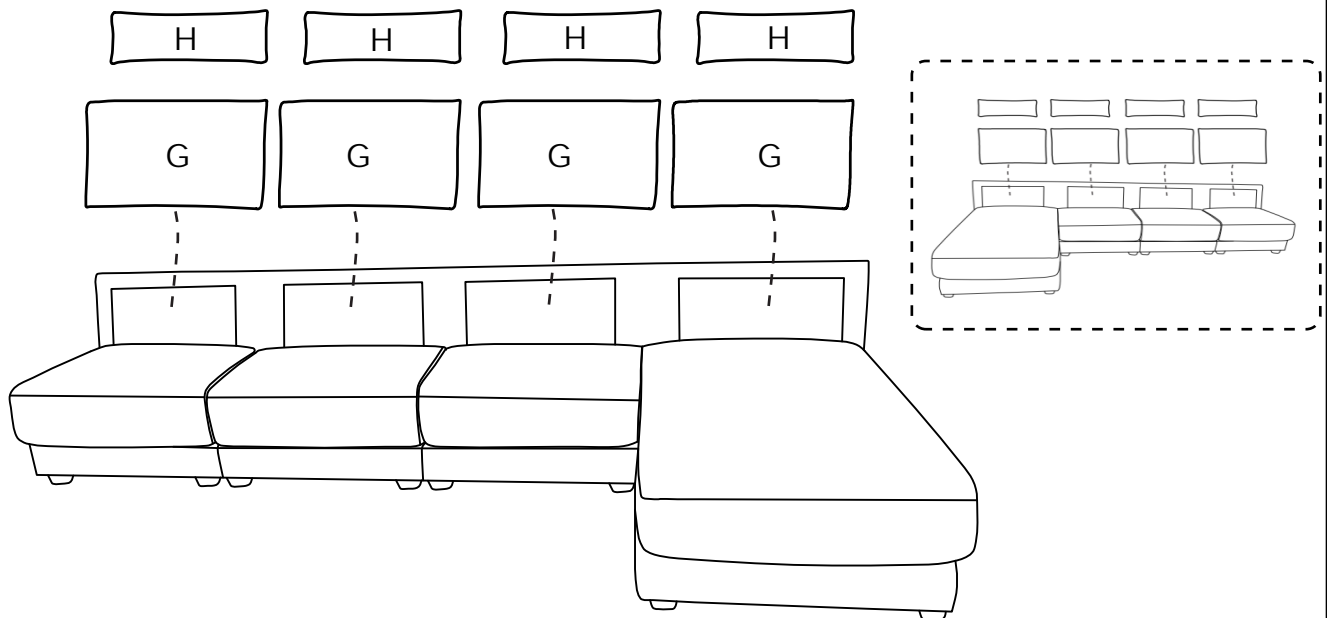
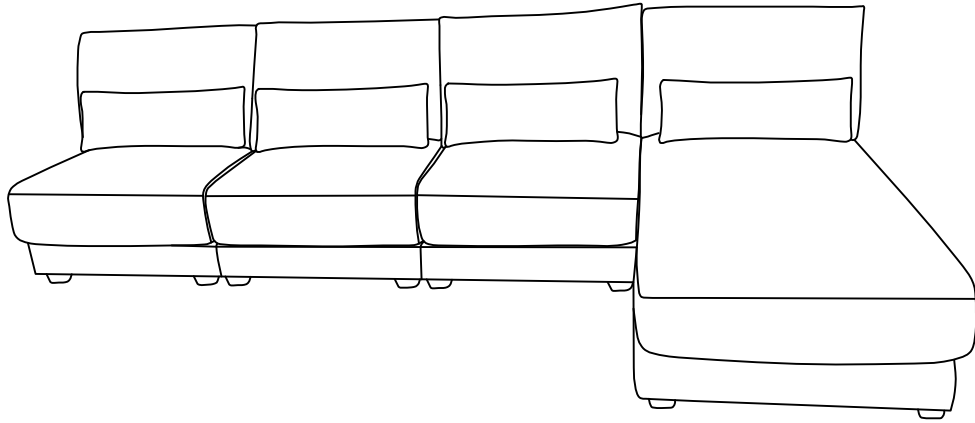

DIAGRAM 7 (Place the Cushion on the sofa)

Place the Back cushions (Part G) and Pillows (Part H) on the sofa.



Note: The chaise of the sofa can be interchanged left and right, and you can assemble it according to your own needs.



↓ OR

