

# Assembly Instructions

Caution: ●You must read this before you proceed.

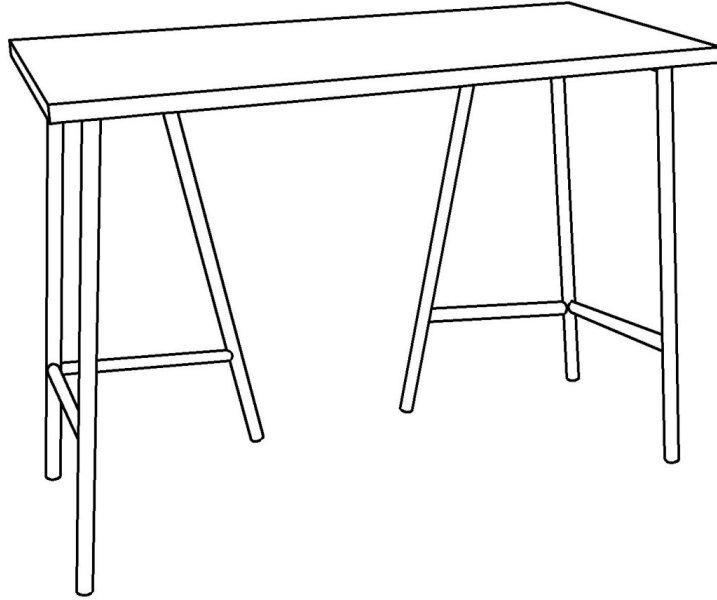

## DESK

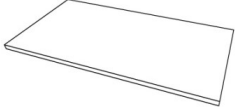
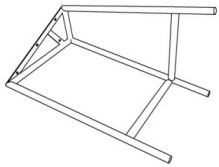
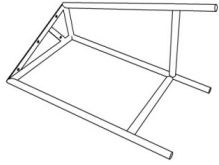

## Parts List

Label	Picture	Description	QTY
A		TOP	1
B		LEG	1
C		LEG	1

## Hardware

Label	Picture	Description	QTY
①		Allen Bolt (button Head)8x20mm	10
②		Allen Key 5mm	1

# Assembly Preparation

Before Beginning Assembly :

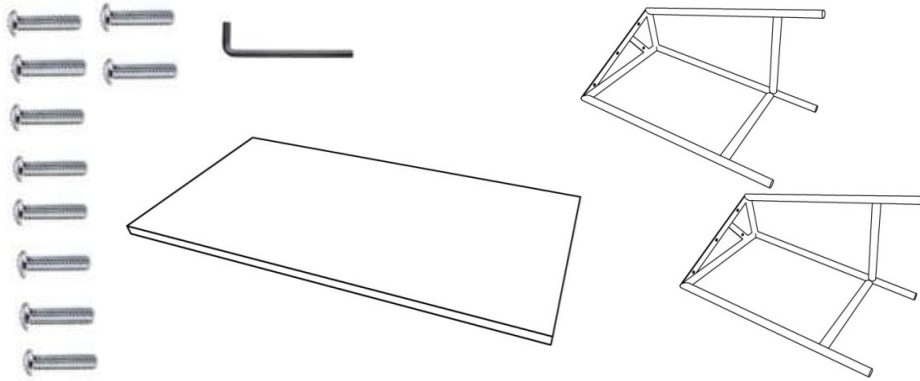

- Read instructions, cover to cover-



- Have 2 adults on hand for assembly-



- Do not assemble on flooring or carpet-



- Assemble on a clean non-marring surface (packing foam)-



- Save all packaging until finished-

# Assembly Steps

## Overview

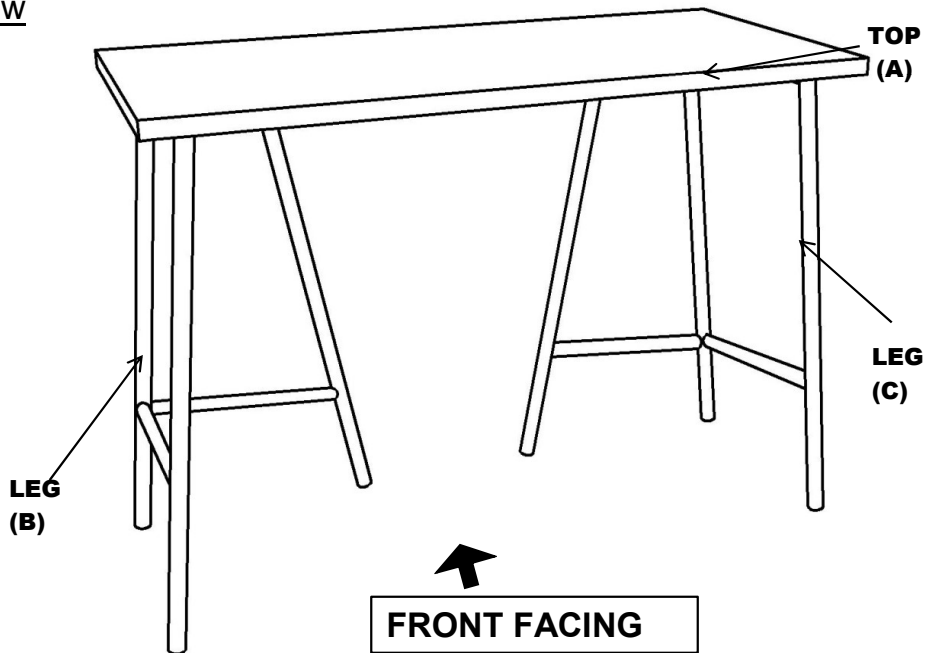

This Desk has multiple parts and may require up to some 30 minutes to assemble. To give you an overview of the Desk parts, the above picture is to help you put the various parts into perspective. Please read through the instructions below to familiarise yourself with the parts and steps before assembly.

## Step 1

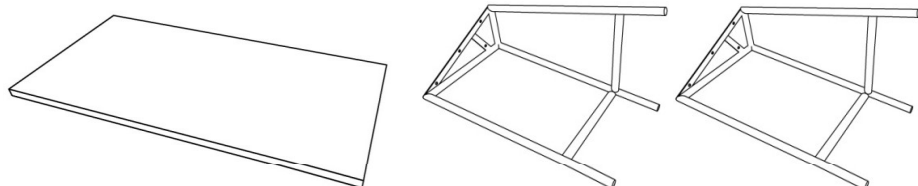

Unpack and place all parts on a clean, non-marring surface.

## Step 2

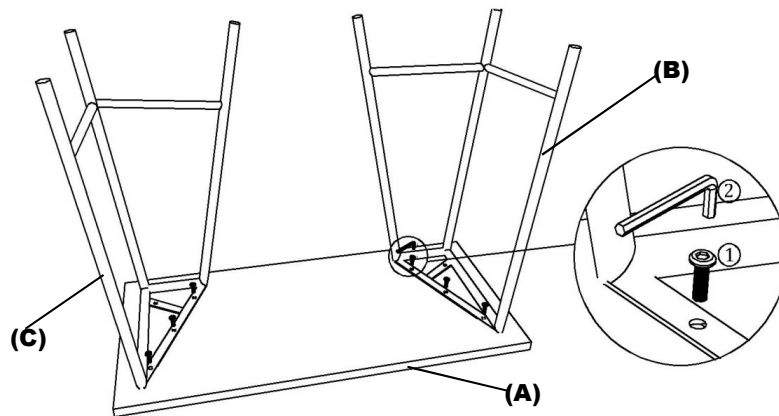





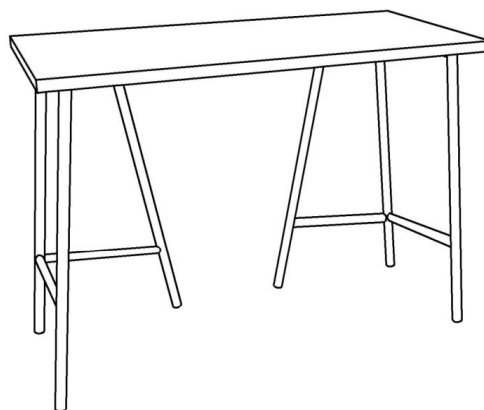





Keep the TOP(A) inverted on the clean surface and bottom facing the top then place the LEG(B) on designated points of TOP (A) as shown above and fix it by using Allen Bolt (①)and Allen Key (②) Repeat the same process with all LEG(B) and connect it with Allen Bolt (①)and Allen Key (②).

## Step 4



Place the Desk on a **LEVEL SURFACE**.  
Inspect it and make sure all parts are adequately connected.  
Turn the Desk in a synchronised manner.  
**CAUTION 1:** When tightening these Bolts, tighten sequentially.  
**DO NOT** tighten any Bolts fully and then towards the next one.  
This would cause the frame to warp.  
If there is still wobbles, loosen the Bolts and execute this same process.  
**WARNING!! IF DESK IS NOT STABLE , IT COULD LEAD TO DAMAGING THE PRODUCT.**  
Ensure all bolts are fully locked into position.  
The Desk is ready to be used.  
**CAUTION 2:** This Desk can only be used on a flat, level surface.

## **Care & Maintenance**

- ✓  ● Furniture may scratch floors. We recommend using furniture pads to protect your floors.
- ⊘  ● Do not put hot items directly on furniture surface.
- ⊘  ● Do not clean furniture with harsh cleansers or polish.
- ⊘  ● Do not place furniture under direct sunlight.
- ⊘  ● Do not place furniture near heating or cooling vents.
- ⊘  ● Do not write on furniture without a padded barrier to protect the surface.
- ⊘  ● Do not place furniture outside . For indoor use only.
- ⊘  ● Not for commercial use. For residential use only.
- ⊘  ● Stains may be removed with mild soap solution and damp cloth.
- ⊘  ● Children should not climb or jump on the furniture.
- ✓  ● Dust and pick-up spills using a clean, non-colored, lint-free cloth.