

A

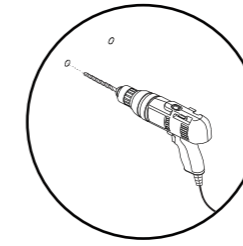

B

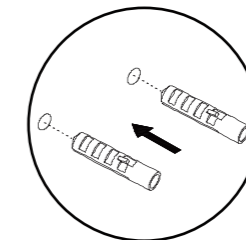

C

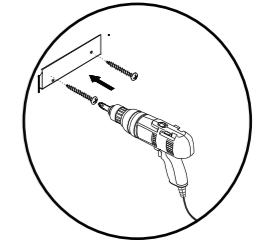

D

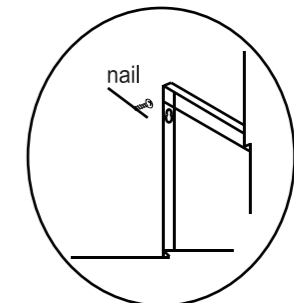

E

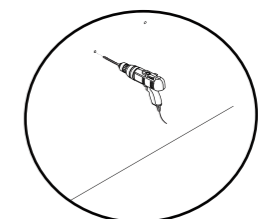

F

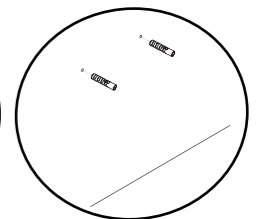

G*

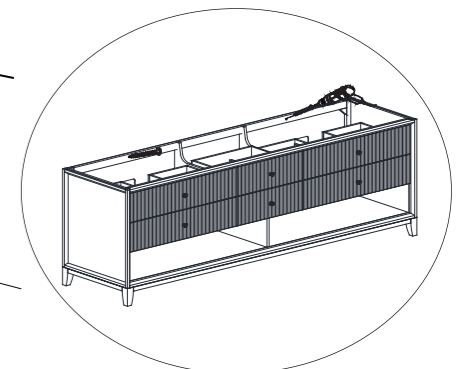
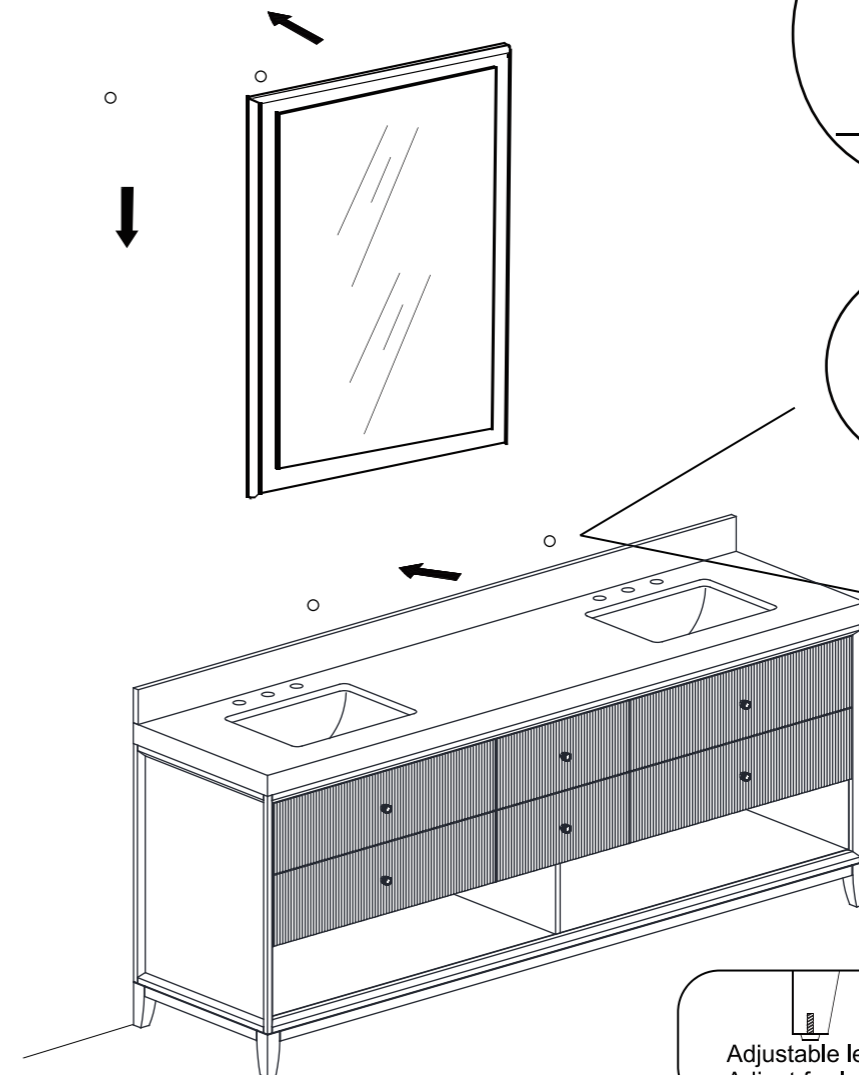

H

Adjustable leg leveler.
Adjust for level.

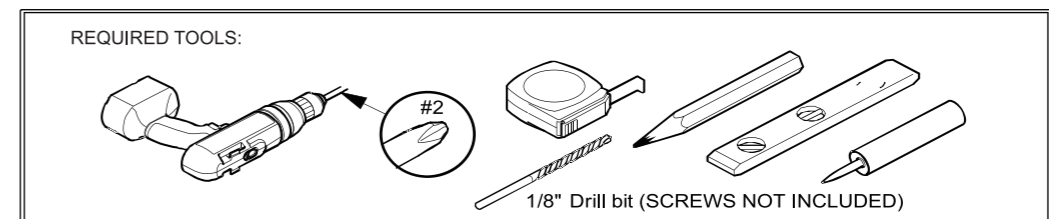

*SECURE SCREW TO STUDS WHEN POSSIBLE



3 Year Limited Warranty

Our team and family would like to thank you for your purchase and we truly value your support! At Ancerre Designs we take pride in our products and will take all necessary steps in making you happy!

We warrant it to be free of defects in material & workmanship for a period of 3 years from the date of purchase to the original owner and installation site. This warranty applies to products that are purchased from an authorized Ancerre Designs dealer and are used under normal residential use.

Our warranty will not cover the following

- Improper Maintenance (Please refer to care & maintenance)
- Damages that was caused by improper installation
- Abuse or alteration of Ancerre Designs products
- Damages caused by fire, flood or any damages caused by the acts of God
- Ancerre Designs is not liable for any labor or material charges, loss of time, loss of profits or any incidental expenses from the use of the products. Does not cover the cost for removal or reinstallaion.
- Warranty will be void if the Ancerre Designs products are installed with obvious visual defects
- Unauthorized dealer or any reseller that is not approved by Ancerre Designs
- Natural stones and Quartz tops will vary (No 2 slabs are alike) in color, pattern & mineral streak from what is shown from our images. This is not consider defect & will not be covered under our warranty.
- All natural wood will age (darken/lighten) over time depending on exposure to light. Natural wood will vary (dark spots, slight splits, mineral streak) in appearance and are not considered defects. In the situation when we send you a replacement doors or drawers, please note we can not guarantee exact color match.

Warranty Service :

To better serve you, please call 888.830.8828. Please have proof purchase or bill when calling in. Thank you.



Care & Maintenance

At Ancerre Designs we're passionate about our handcrafted products. Our products are meticulously crafted and to be cherished for a lifetime. Like everything in life, there will be some care & maintenance that will be involved in prolonging the beauty of our products.

Wood Products: Frequent dusting of your bath furniture & mirror will help maintain the luster finish. Use a dry soft cotton cloth to dust. For cleaning use a clean non-abrasive slightly damp towel with warm water. Wipe of any excess water with a clean dry non-abrasive towel - do not leave siting water on any wood parts. Do Not use all purpose cleaner or any cleaner that is not approved for paint or stain finish. Keep your furniture out of the sun. The temperature of the summer sun coming through a window can go above 140 degrees. It will damage the fine finish and dry out and shrink the wood, which will cause cracks. Don't place wood furniture near heating units or vents. Dry heat will cause the wood to dry and shrink, leaving cracks.

IMPORTANT

Natural Stone: Please clean natural stone (marble | granite) top with a clean soft microfiber towel. We recommend using a natural stone cleaner to protect the finish. DO NOT use bleach, acidic cleaners, or any abrasive household cleaners with natural stone, as etching, dullness & staining may occur. Never leave achemical, citric or acidic item, or substance on natural stone. **Please seal the top with a natural stone sealer before use.** The sealant will protect it from staining. You can purchase this stone sealant at any home improvement store.

Quartz Stone: Top: Simply clean with a slightly damp cloth and then dry with a soft towel. Do Not use bleach, acidic cleaners, or any abrasive household cleaners with quartz stone, as etching and dullness may occur - this will void the warranty. DO NOT use abrasive or harsh scrub pads. DO NOT apply any sealers, penetrants or topical treatments.

Matte Solid Surface: To clean solid surface countertops, use a damp microfiber cloth to wipe down. For more dirty or stained areas, try a mild dish soap and water. Towel dry the surface. For tougher stains, you can use an abrasive cleaner such as baking soda.

Ceramic Products: Clean with a sponge with warm water. Do Not use bleach, acidic cleaners, or any abrasive household cleaners as etching and dullness may occur - this will void the warranty. DO NOT use abrasive or harsh scrub pads.

IMPROPER CARE WILL VOID THE WARRANTY

Customer Service:

To better serve you, please call 888.830.8828

www.ancerre.com | orders@ancerre.com