

# Instruction Manual

## Stand For Egg Chair

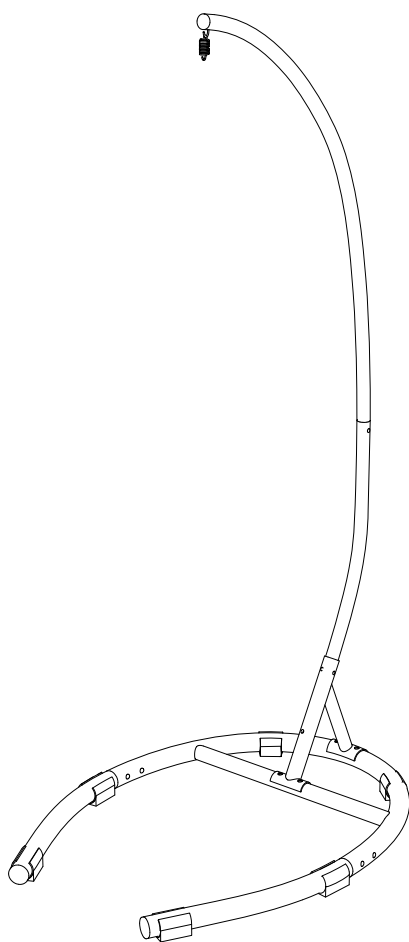





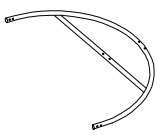

**Read the instructions before use of this product.**

Please keep this instruction manual for future reference.

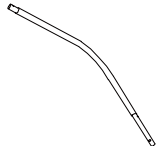
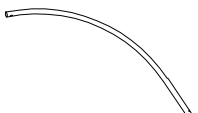







## PARTS & HARDWARE LIST





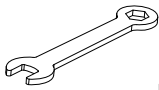
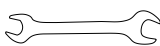

PART	FIGURE	DESCRIPTION	QTY
G		Base Tube	2PCS
H		Base	1PC
I		Connetor	1PC
J		Tube	1PC
K		Tube	1PC
L		Pin Plug	1PC
M		Spring	1PC
P		Plastic Clip	6PCS

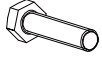

## PARTS & HARDWARE LIST

PART	FIGURE	DESCRIPTION	QTY
CC	 M8*15	Bolt M8*15	5PCS
DD	 M8*65	Bolt M8*65	2PCS
EE	 M8*55	Bolt M8*55	4PCS
JJ	 M8	Washer	17PCS
KK	 M8	Bolt Cap	11PCS
LL	 M8	Nut	6PCS
MM	 M8	Nut Cap	6PCS
OO	 M8	Wrench	1PC
PP	 M8	Wrench	1PC



EXTRA			
PART	FIGURE	DESCRIPTION	QTY
CC	 M8*15	Bolt M8*15	1PCS
DD	 M8*65	Bolt M8*65	1PCS
EE	 M8*55	Bolt M8*55	1PCS
JJ	 M8	Washer	3PCS
KK	 M8	Bolt Cap	3PCS
LL	 M8	Nut	1PCS
MM	 M8	Nut Cap	1PCS

**ATTENTION:**

Keep children away during assembly. This item contains small parts that can be dangerous for children. Children should always be under direct adult supervision while using this product. Do not discard of any of the packaging until you have checked that you have all of the parts and fittings required. Carefully remove the contents from the package. If any parts are missing, do not attempt to use the product until they have been obtained. Make sure that each bolt needed for all steps matches the corresponding figure ensure proper assembly.



### STEP 1

Attach base tubes (G) to base (H) using bolts M8\*55 (EE), washers (JJ), nuts (LL), bolt caps (KK) and nut caps (MM).

Please fully tighten all bolts using wrench (OO) and wrench (PP).

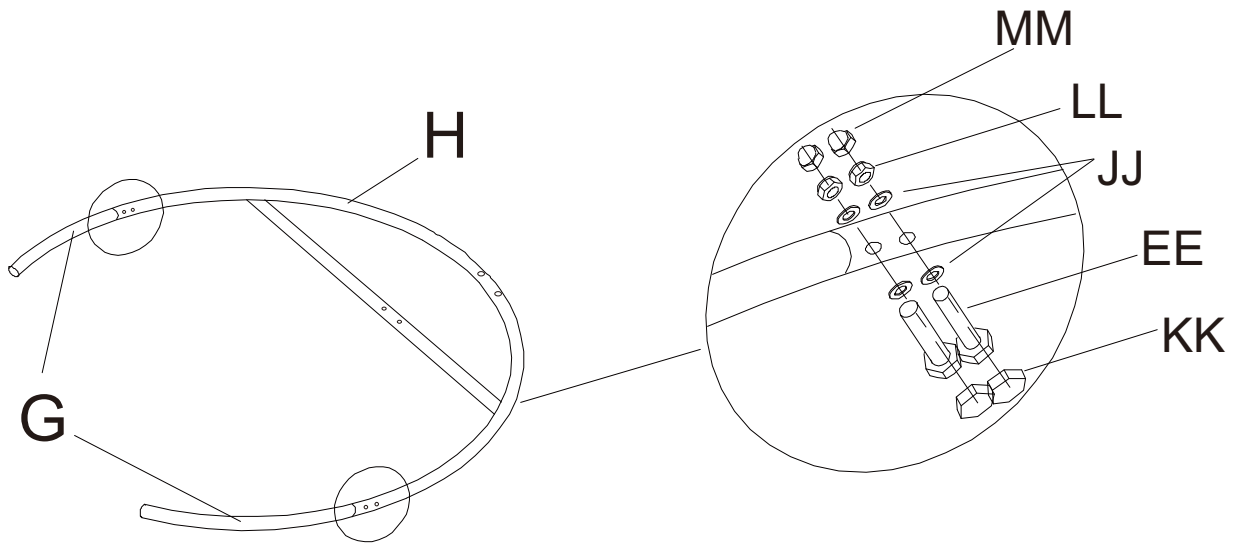

### STEP 2

Attach plastic clips (P) to assembled unit (G & H).

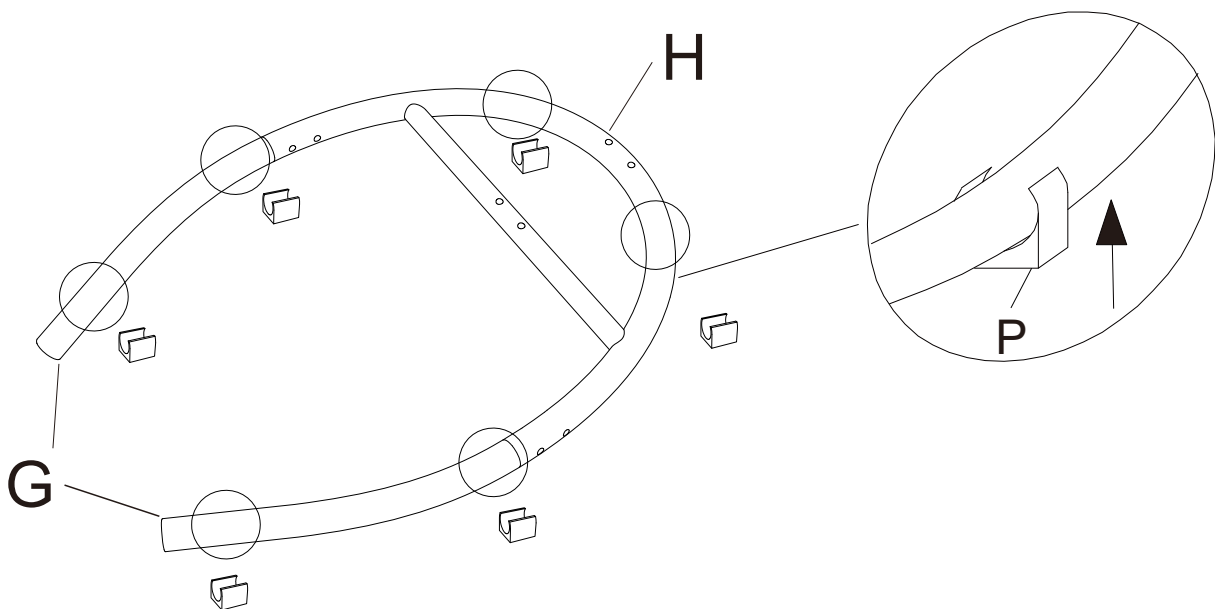



### STEP 3

Attach connector (I) to base using bolts M8\*15 (CC), washers (JJ) and bolt caps (KK).  
Please fully tighten all bolts using wrench (PP).

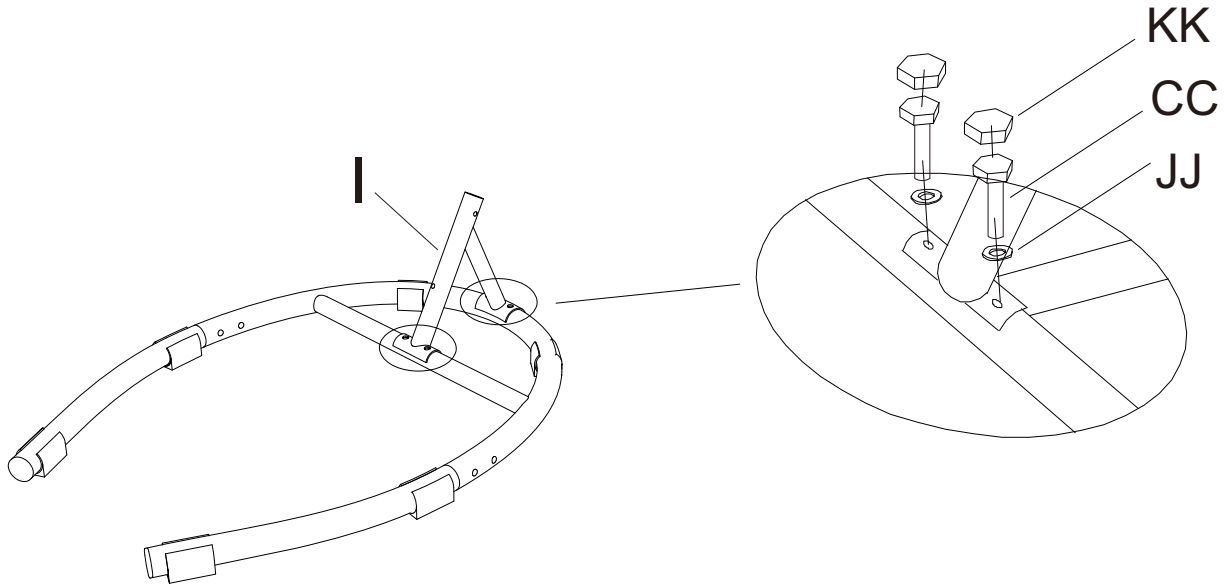

### STEP 4

Attach tube (J) to connector (I) using bolts M8\*65 (DD), washers (JJ), nuts (LL), nut caps (MM) and bolt caps (KK).  
Please do not fully tighten bolts until unit is fully assembled.

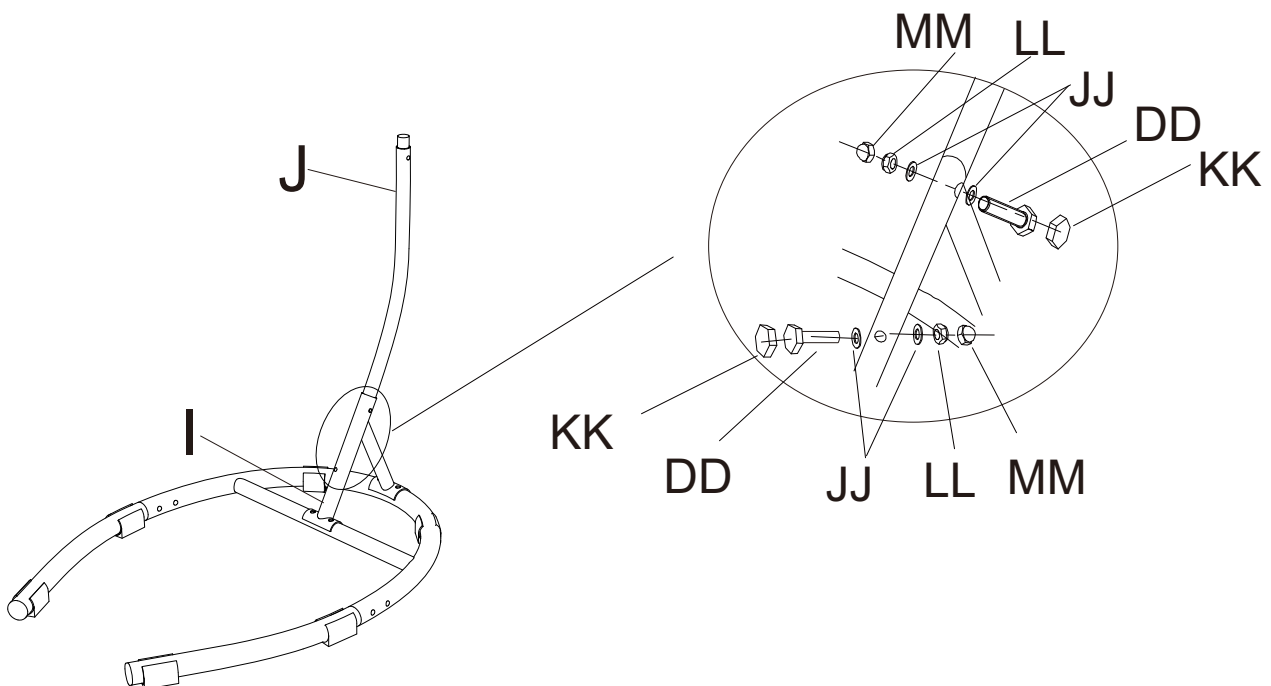



### STEP 5

Attach tube (K) to tube (J) using bolts (CC), washers (JJ) and bolt caps (KK). Please fully tighten all bolts. Cover all caps.

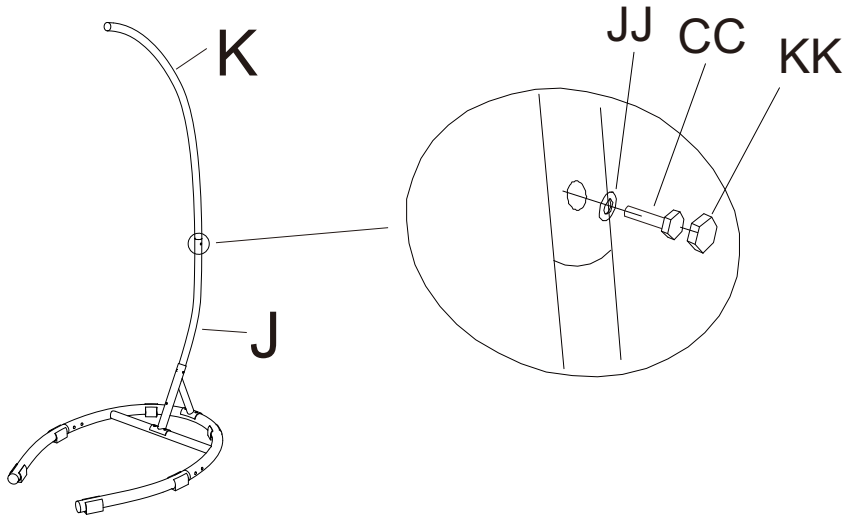

### STEP 6

Insert pin plug (L) into tube (K). Attach spring (M) to pin plug (L).

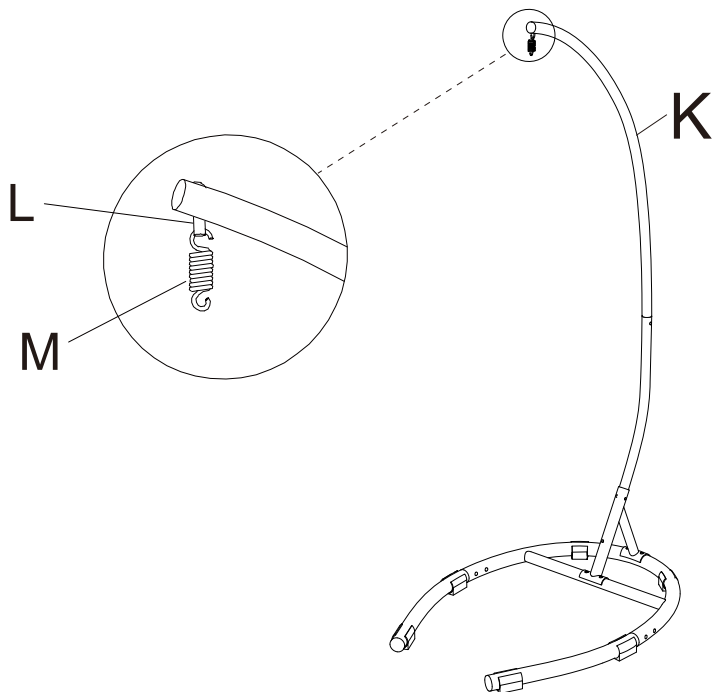

## Cleaning and Maintenance

Clean frame with mild soapy water, rinse thoroughly. Dry frame parts completely. Do not use bleach, acid, or other solvents on the fabric and metal parts. We recommend the use of furniture covers to protect the stand when not in use.

Inspect and tighten all bolts on a regular basis to ensure proper performance and safety.

In order to prolong the life and beauty of your stand, we recommend storing it in a dry and protective area during off season periods.