

HPS-02 Plant stand

The assembly instructions

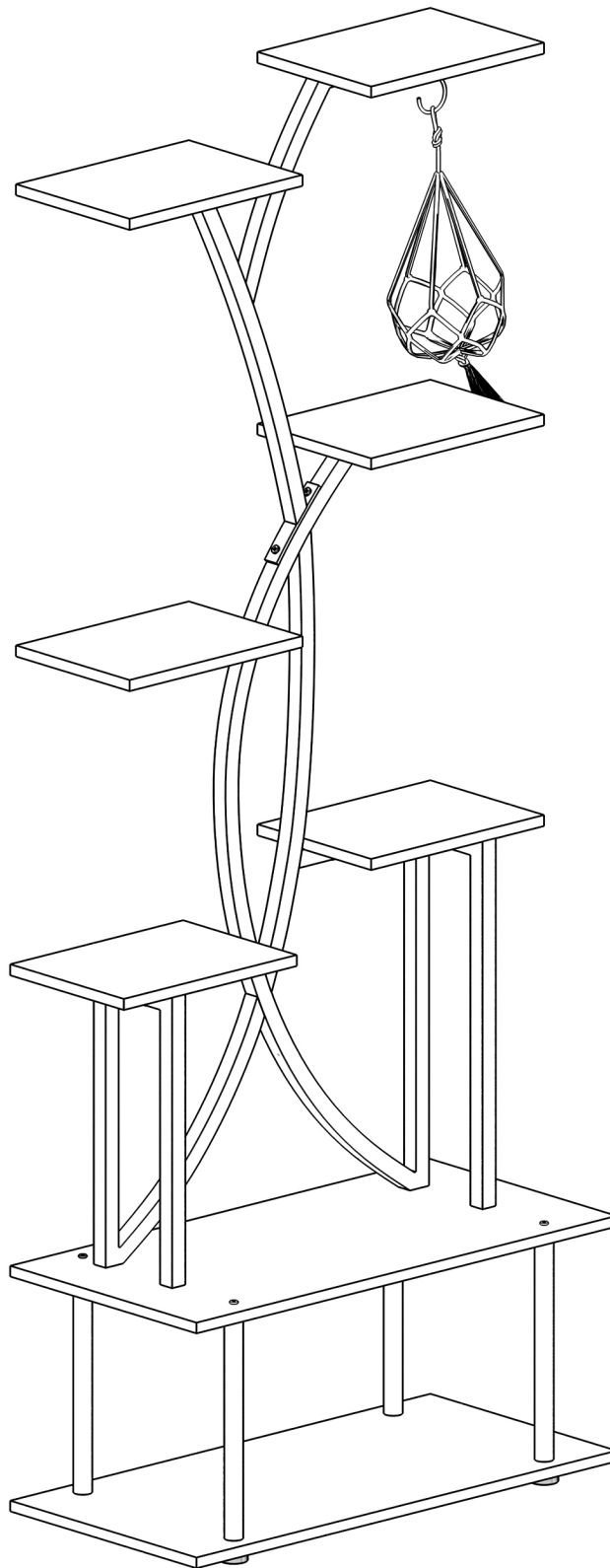

Thank you for purchasing our products, please read the instructions carefully before you assemble the product, please do not hesitate to contact us if there is assembly problem, there will be someone to guide assembly.

MATTERS NEEDING ATTENTION

Please follow the instruction manuals and use a pad to avoid damage during assembly.

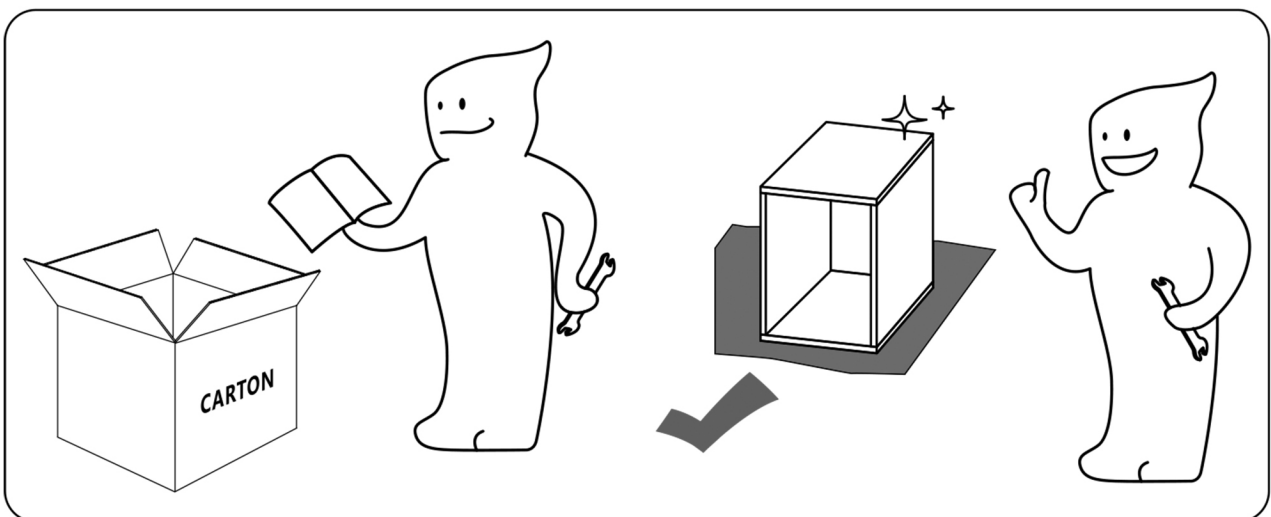
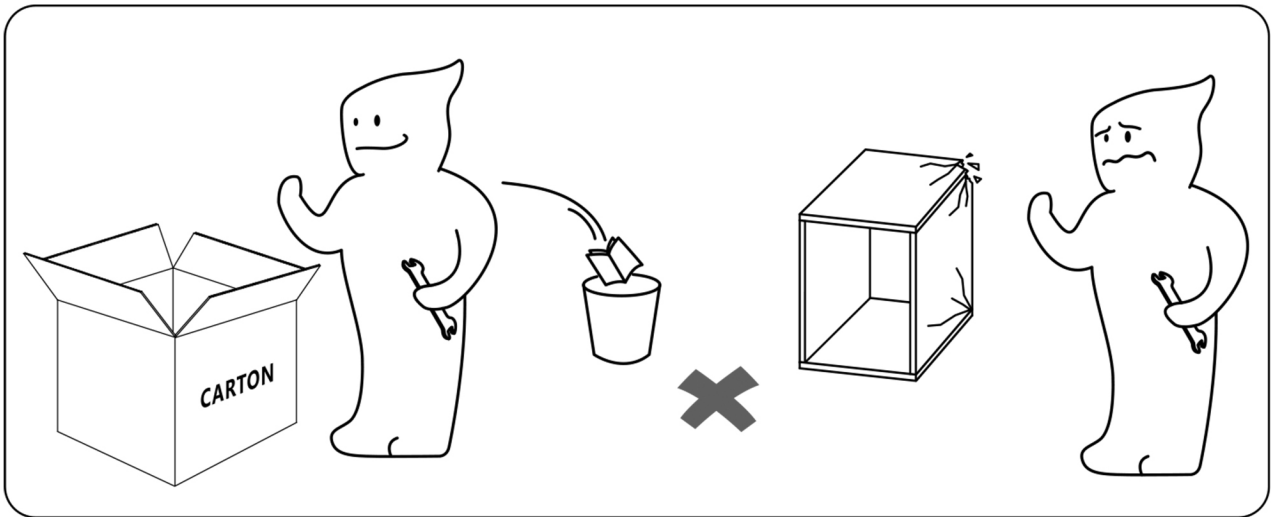

1  Not intended for use by children.







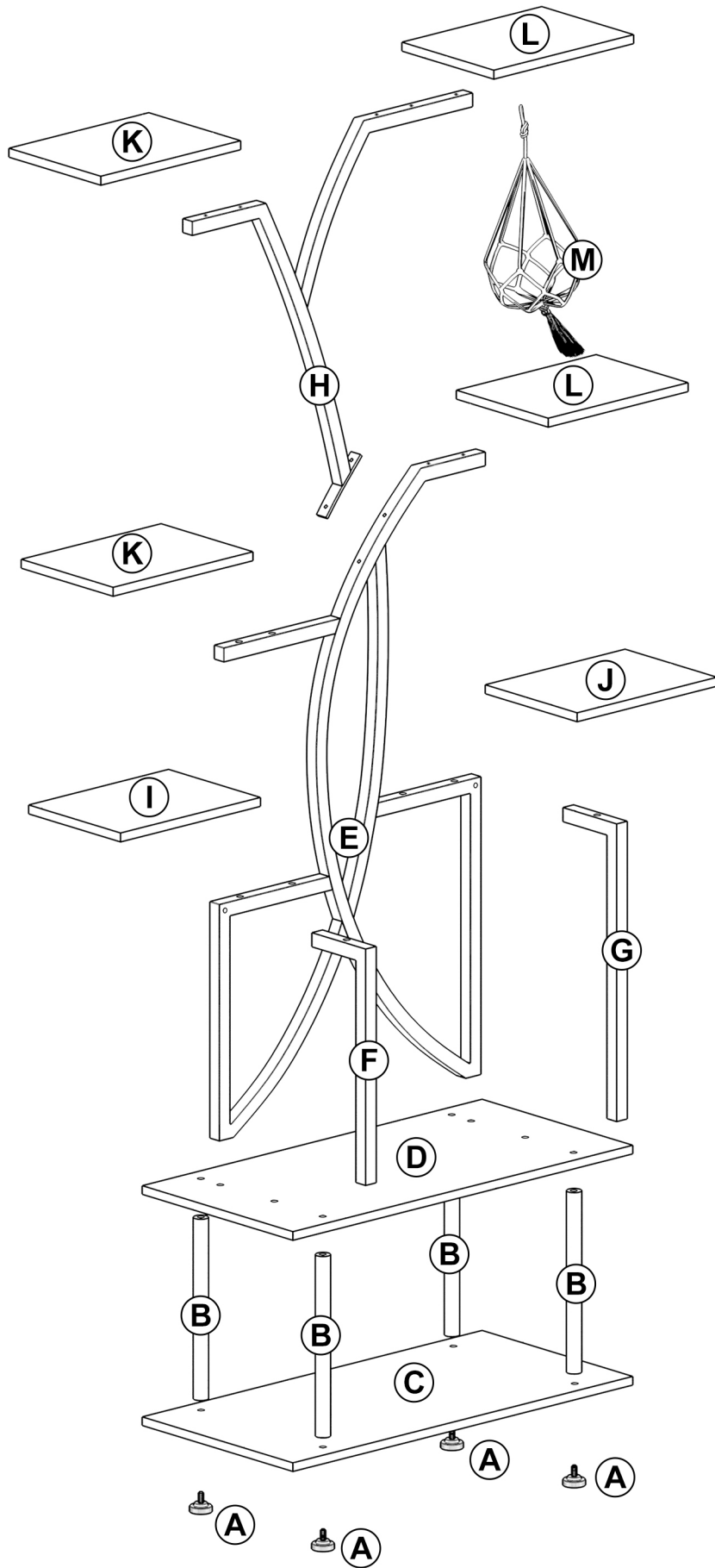

2  Keep away from fire or other heat sources.

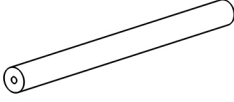
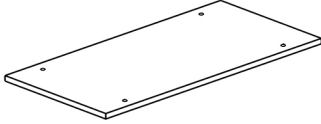
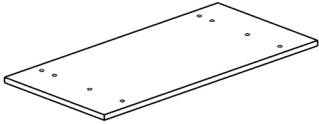
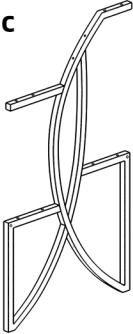
3  We recommend wearing protective gloves.

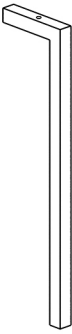
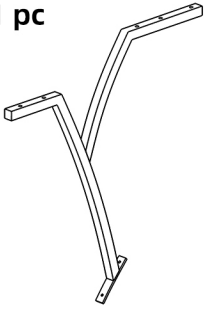
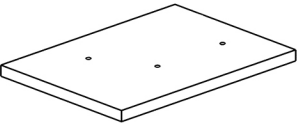
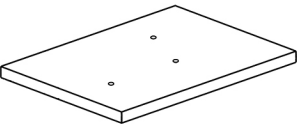
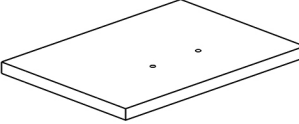
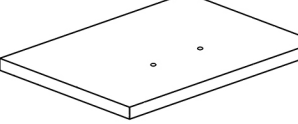
● Product accessories

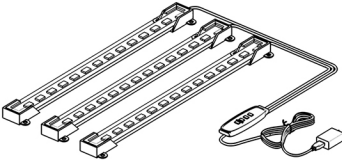
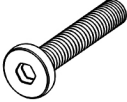
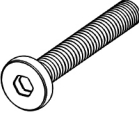
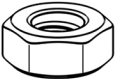

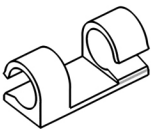

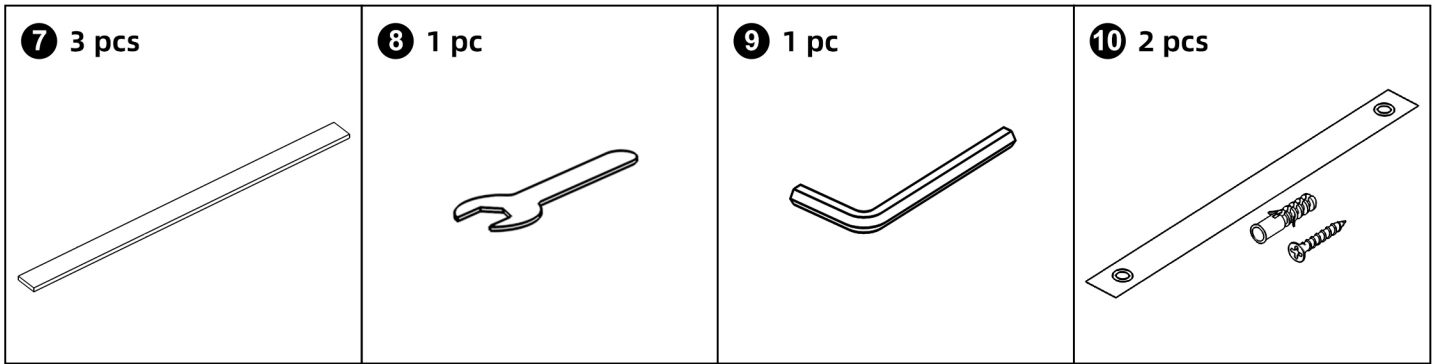

● Accessories List

<p>A 4 pcs</p> 	<p>B 4 pcs</p> 	<p>C 1 pc</p> 	<p>D 1 pc</p> 
<p>E 1 pc</p> 	<p>F 1 pc</p> 	<p>G 1 pc</p> 	<p>H 1 pc</p> 
<p>I 1 pc</p> 	<p>J 1 pc</p> 	<p>K 2 pcs</p> 	<p>L 2 pcs</p> 
<p>M 1 pc</p> 	<p>N 1 pc</p> 	<p>1 24 pcs</p> 	<p>2 2 pcs</p> 
<p>3 2 pcs</p> 	<p>4 1 pc</p> 	<p>5 4 pcs</p> 	<p>6 4 pcs</p> 



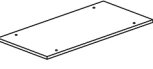
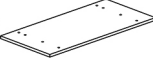

● Assemble steps

● Step 1

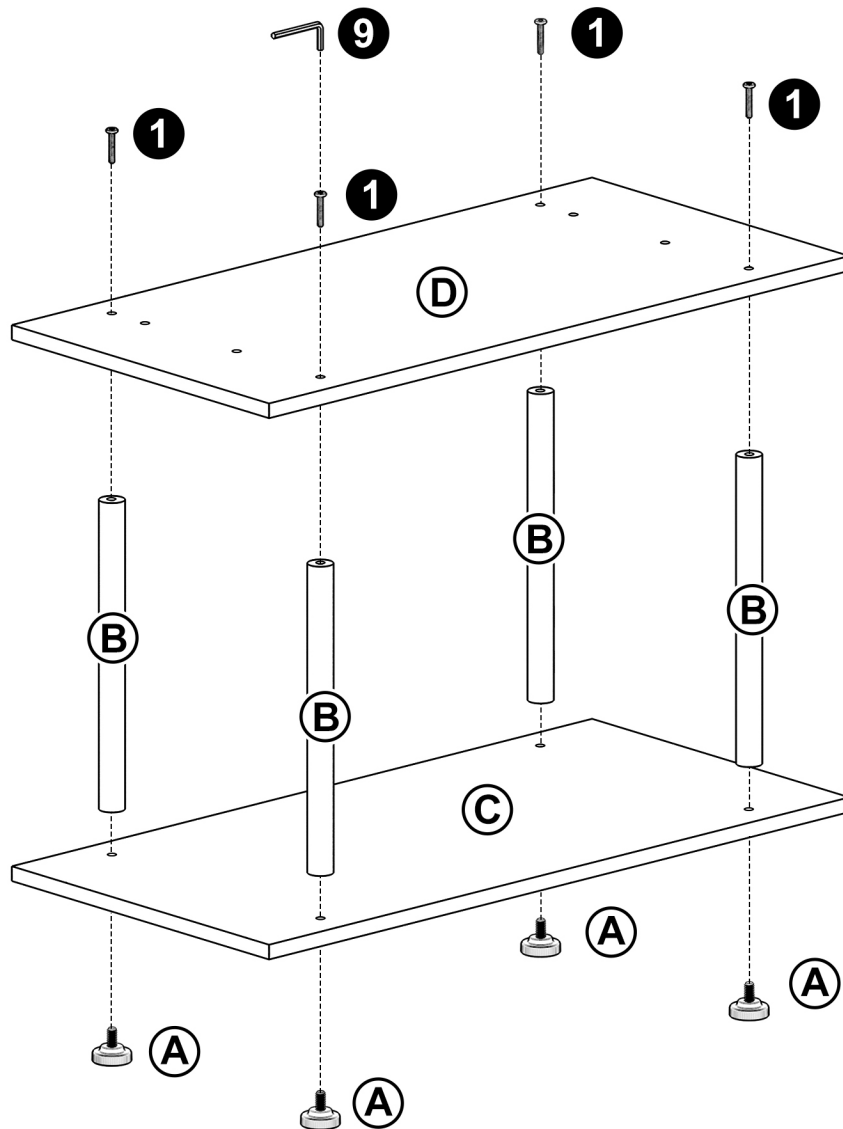
A	B	C	D	1	9
 X4	 X4	 X1	 X1	 X4	 X1



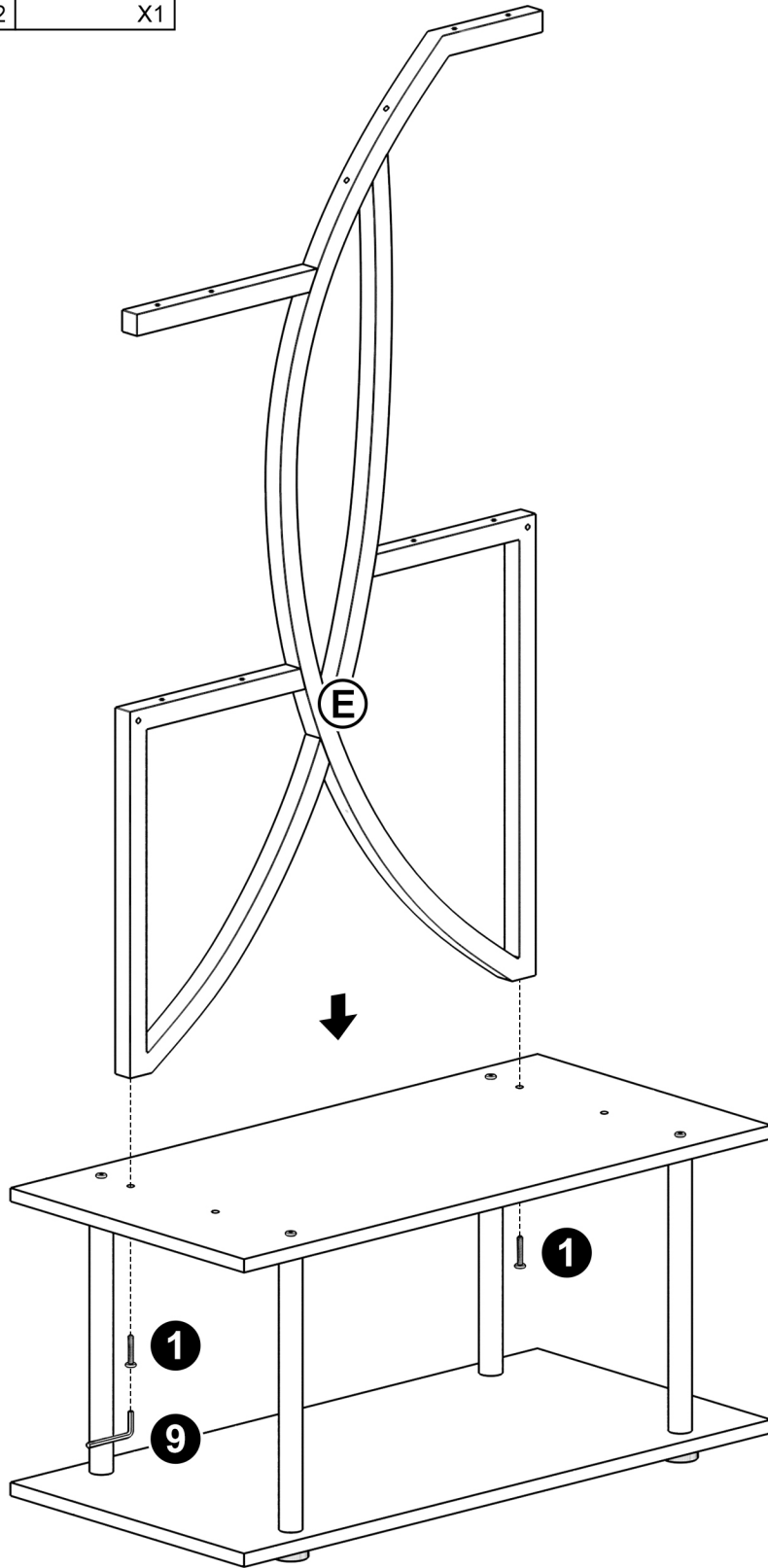

● Step 2

E	1	9
 X1	 X2	 X1



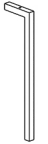

● Step 3

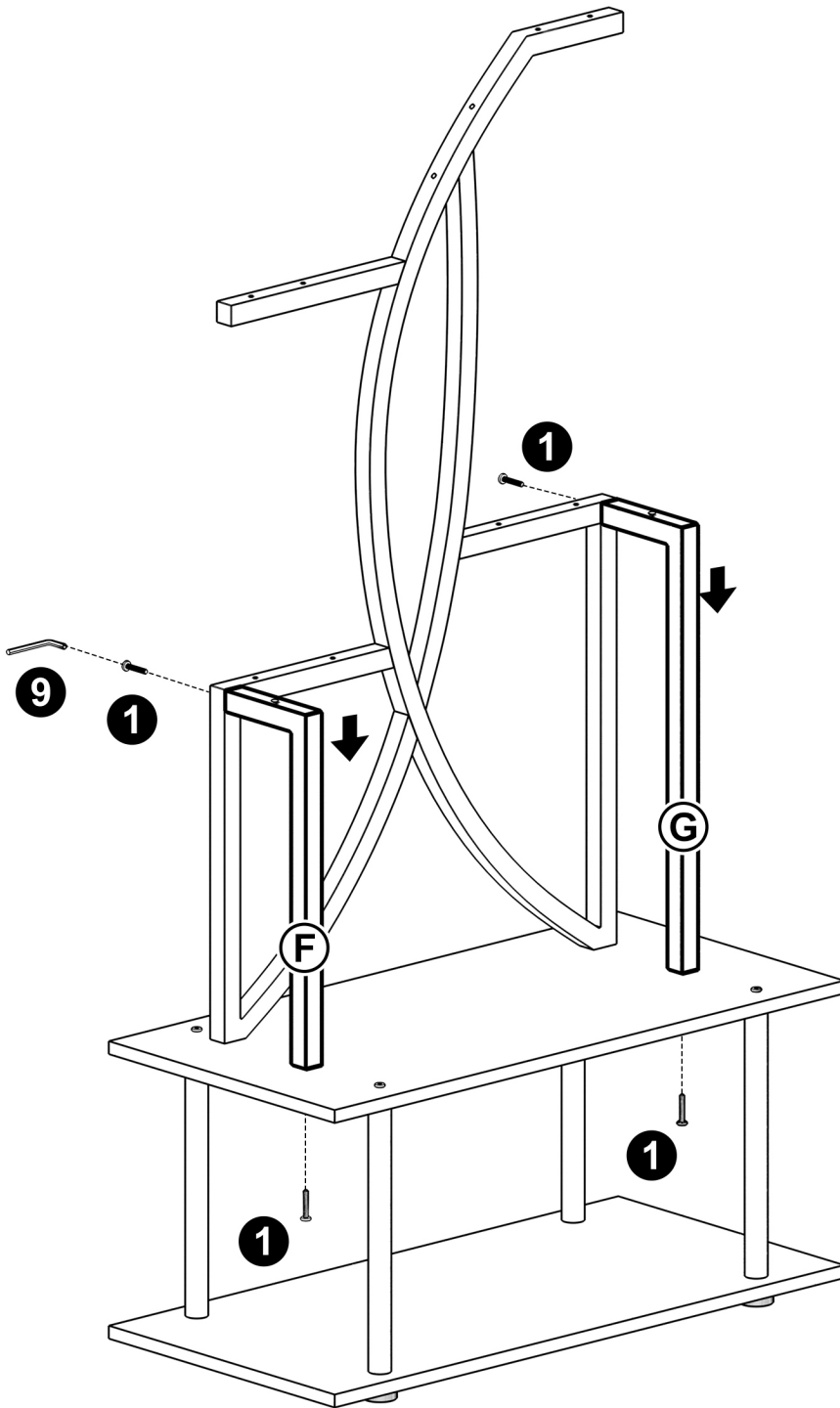
F  X1	G  X1	1  X4	9  X1
---	---	---	---



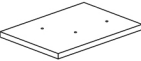
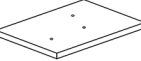



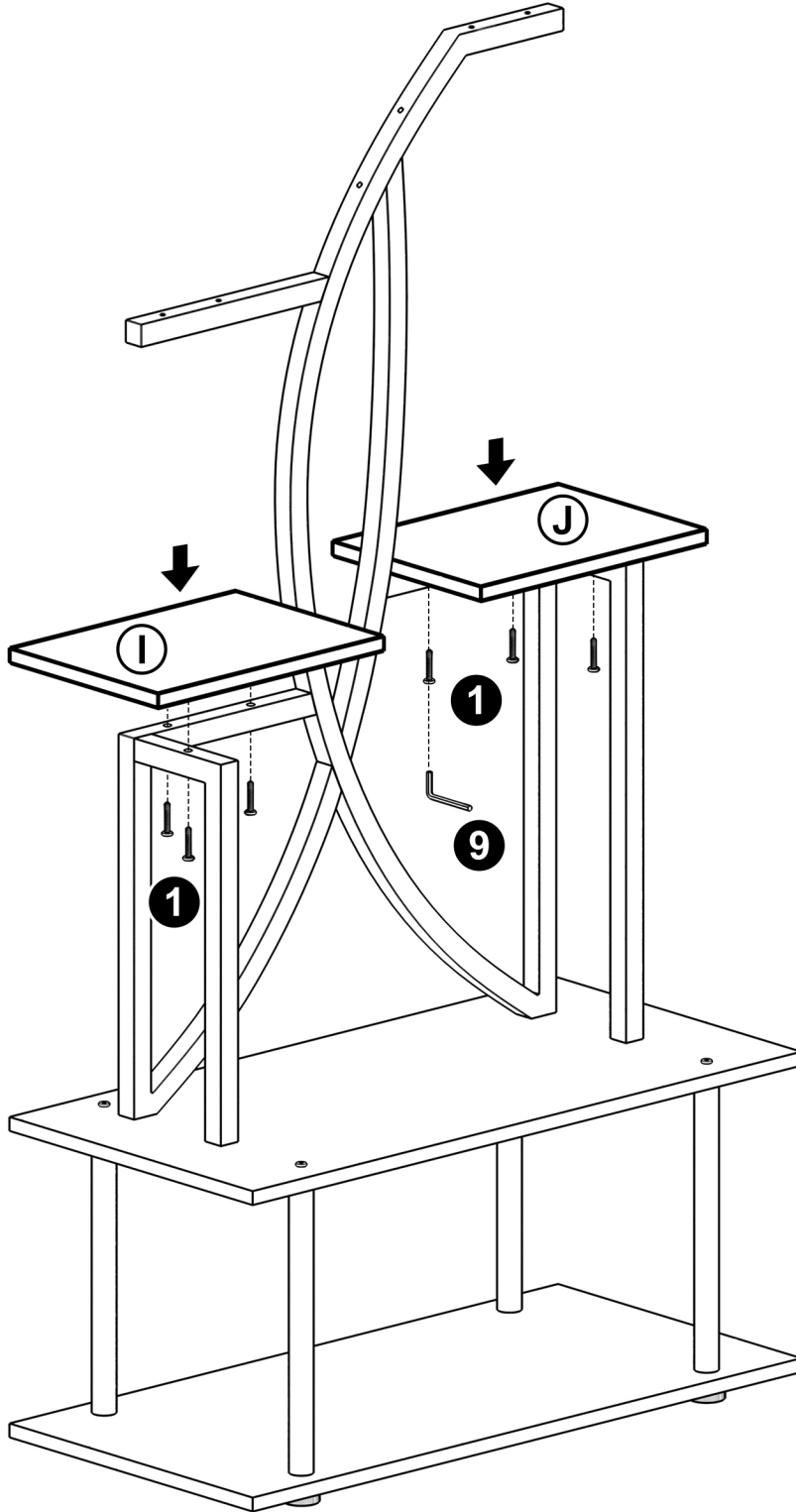

● Step 4

I	J	1	9
			
X1	X1	X6	X1





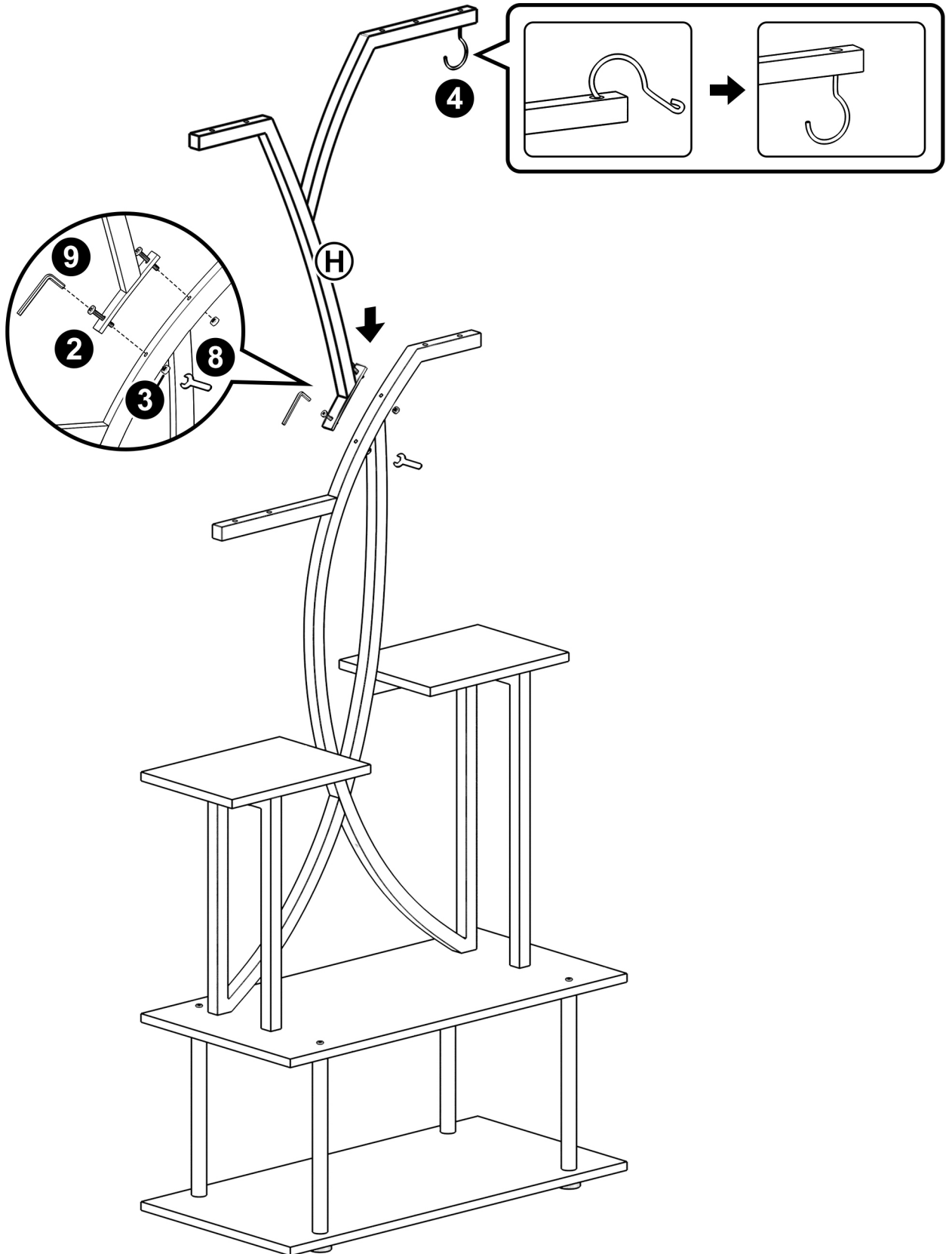

● Step 5

H	2	3	4	8	9
 X1	 X2	 X2	 X1	 X1	 X1

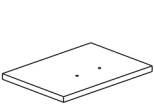
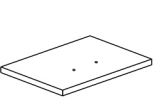

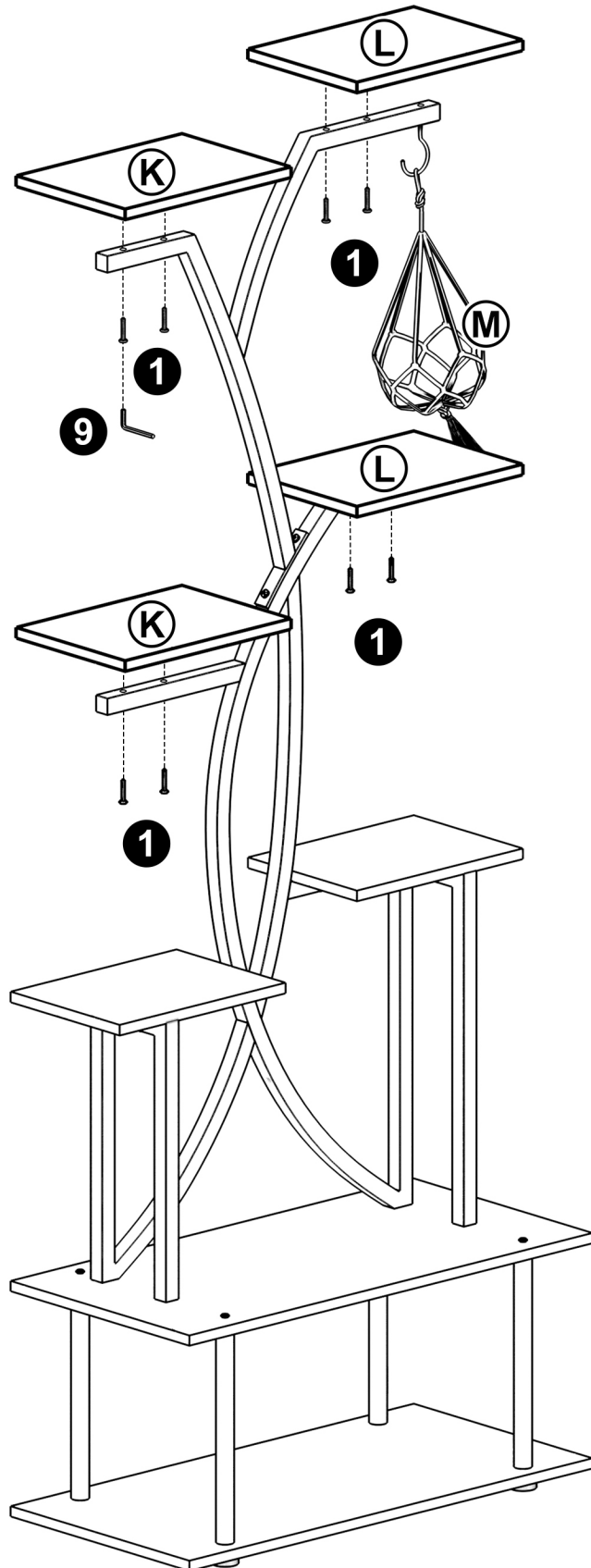

● Step 6

K	L	M	1	9
				
X2	X2	X1	X8	X1

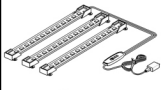
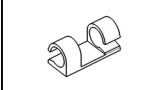

● Step 7

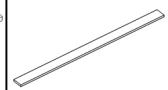
N	5	6	7
 X1	 X4	 X4	 X3

Accessory **N** has a separate instruction manual in the box of the lamp. Please refer to the separate instruction manual of the lamp.

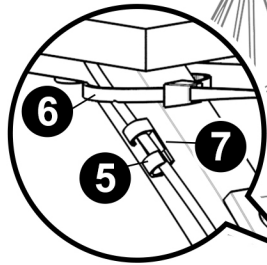

Comes with cable ties and buckles for fixing plant light cords.

! This side is against the wall.

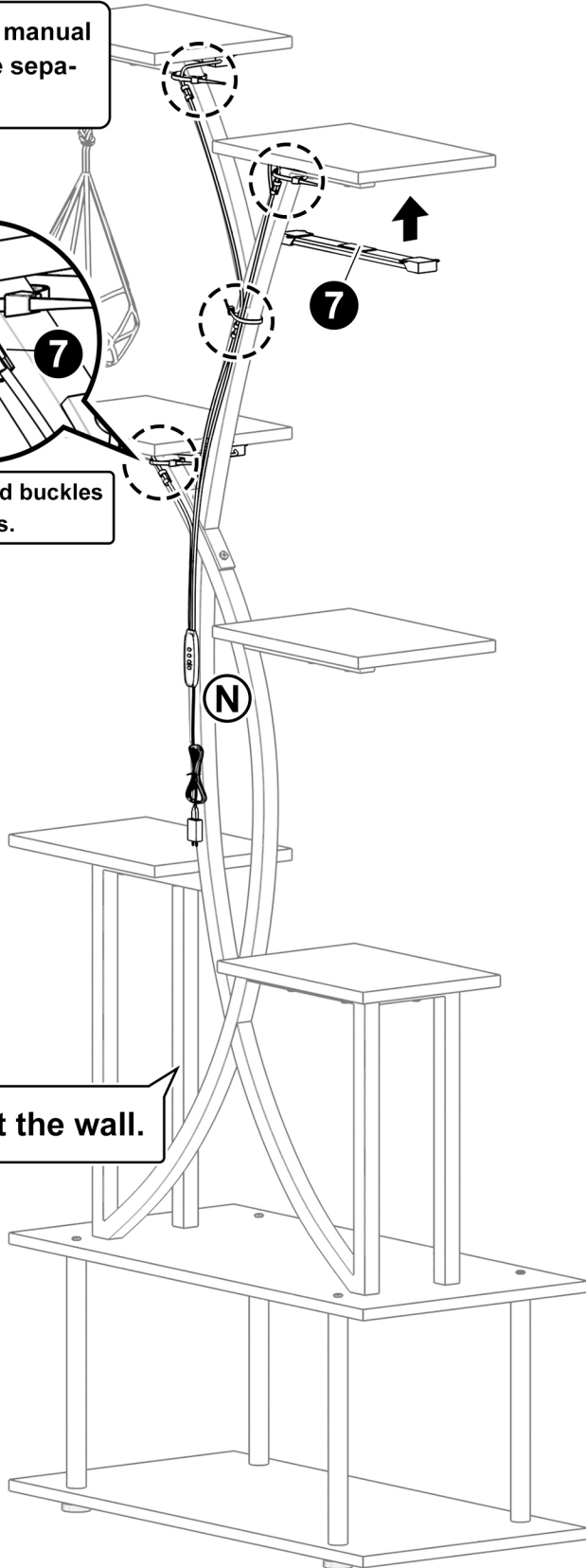

● Step 8

10

