

























01 Swivel Chair, Set of 2

01SC

1. Please check the box part list. If there are any missing/damaged parts, please mark × and write the missing quantity.
2. Then contact the after-sales team. Please attach a picture of this list and clearly indicate the missing/damaged part number + quantity.





NO.	PART.	QTY.	√/×	QTY.
A		2		
B		2		
C		2		
D		2		
E		2		
F		2		
G		2		
H		2		
I		2		
J		2		
K		8		
L		2		





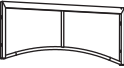
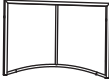
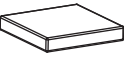

NO.	PART.	QTY.	√/×	QTY.
M		2		
N		2		
O	 M6x20 mm	18		
Q	 M6x25 mm	4		
R	 M6x35 mm	44		
S	 M6x40 mm	8		
T	 M6x45 mm	8		
U		8		
V		24		
W		16		
X		1		
Y		1		

01 Fixed Chair, Set of 2

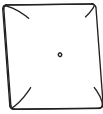
01FC

1. Please check the box part list. If there are any missing/damaged parts, please mark × and write the missing quantity.
2. Then contact the after-sales team. Please attach a picture of this list and clearly indicate the missing/damaged part number + quantity.













NO.	PART.	QTY.	√/×	QTY.
A		2		
B		2		
C		2		
D		2		
E		2		
F		2		
G		2		

NO.	PART.	QTY.	√/×	QTY.
H		2		
I	 M6x20 mm	2		
J	 M6x25 mm	4		
K	 M6x35 mm	20		
L	 M6x40 mm	8		
M		1		

01 Sofa

01SF

1. Please check the box part list. If there are any missing/damaged parts, please mark × and write the missing quantity.
2. Then contact the after-sales team. Please attach a picture of this list and clearly indicate the missing/damaged part number + quantity.





NO.	PART.	QTY.	√/×	QTY.
A		1		
B		1		
C		3		
D		1		
E		1		
F		1		
G		1		
H		1		
K		1		
L		1		
M		1		
N		1		
O		3		





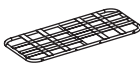

NO.	PART.	QTY.	√/×	QTY.
P		3		
1	 M6x20 mm	13		
2	 M6x25 mm	2		
3	 M6x35 mm	10		
4	 M6x40 mm	8		
5	 M6x45 mm	2		
6	 M6x85 mm	2		
7	 M6	8		
8	 M6	4		
9	 M6x20 mm	4		
10	 M8x35 mm	4		
11		1		
12		1		

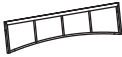
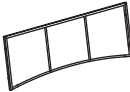
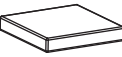
01 Loveseat

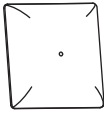
01LS

1. Please check the box part list. If there are any missing/damaged parts, please mark × and write the missing quantity.
2. Then contact the after-sales team. Please attach a picture of this list and clearly indicate the missing/damaged part number + quantity.





NO.	PART.	QTY.	√/×	QTY.
A		1		
B		1		
C		1		
D		1		
E		1		
F		1		
G		2		

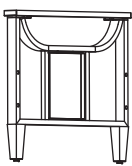

NO.	PART.	QTY.	√/×	QTY.
H		2		
I	 M6x20 mm	3		
J	 M6x25 mm	2		
K	 M6x35 mm	10		
L	 M6x40 mm	6		
M		1		

01 Ottoman, Set of 2

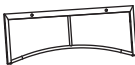
010T

1. Please check the box part list. If there are any missing/damaged parts, please mark × and write the missing quantity.
2. Then contact the after-sales team. Please attach a picture of this list and clearly indicate the missing/damaged part number + quantity.



NO.	PART.	QTY.	√/×	QTY.
A		4		
B		2		
C		4		
D		2		



NO.	PART.	QTY.	√/×	QTY.
E	 M6x40 mm	8		
F	 M6x35 mm	16		
G		1		

01 Coffee Table

01CT

1. Please check the box part list. If there are any missing/damaged parts, please mark × and write the missing quantity.
2. Then contact the after-sales team. Please attach a picture of this list and clearly indicate the missing/damaged part number + quantity.



NO.	PART.	QTY.	√/×	QTY.
A		1		
B		4		



NO.	PART.	QTY.	√/×	QTY.
D	 M6x20 mm	16		
E		1		

01 Side Table

01ST

1. Please check the box part list. If there are any missing/damaged parts, please mark × and write the missing quantity.
2. Then contact the after-sales team. Please attach a picture of this list and clearly indicate the missing/damaged part number + quantity.

NO.	PART.	QTY.	√/×	QTY.
A		1		
B		4		
C		1		

NO.	PART.	QTY.	√/×	QTY.
D	 M6x20 mm	12		
E		1		