

ASSEMBLY INSTRUCTIONS

CHAIR

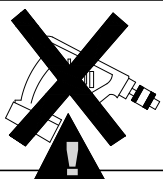

- . Use of power tool to assemble this product will invalidate any claim and damage this product making it unsafe!!!
- . Please assemble on a clean soft surface to avoid damage.

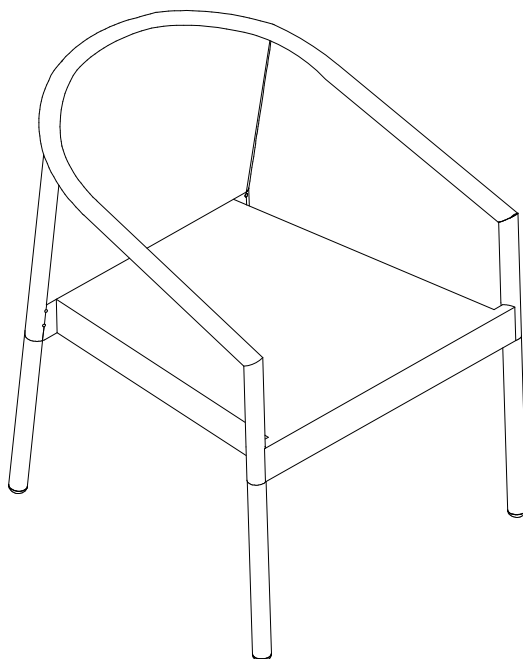
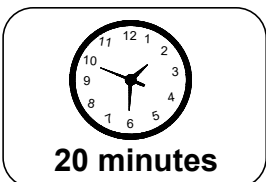
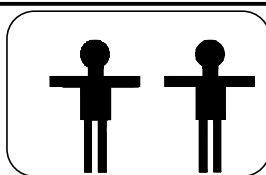

Tool Included

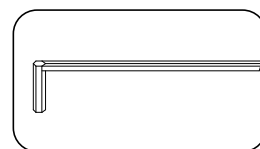

Part List- Chair

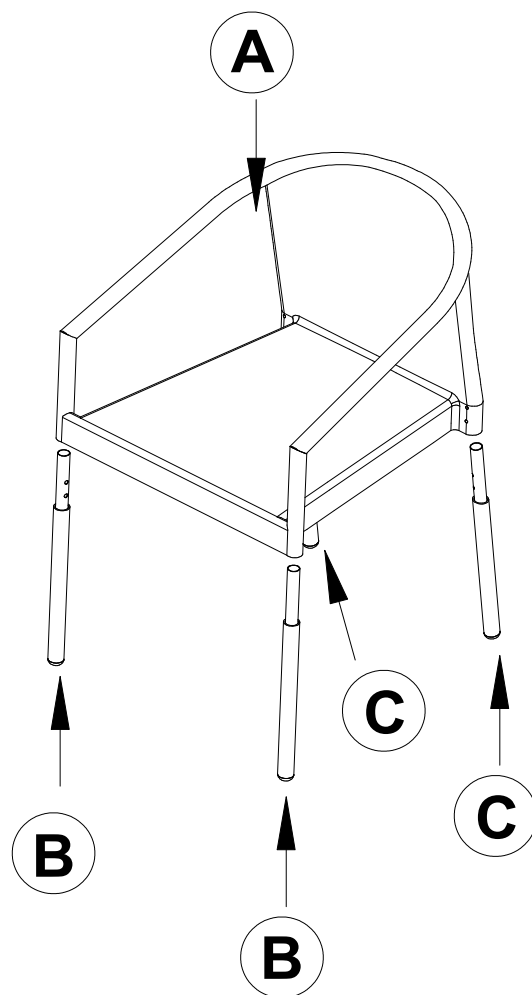

Identifying the hardware-Identify the hardware using the illustrations below.

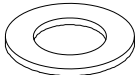
D  **08**

E  **08**
M6x20mm

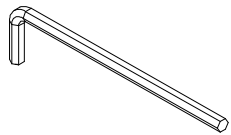
F  **01**

STEP 1

