

# Assembly Instructions

**Caution : Please read this carefully before you proceed**

**Please look in Red Bag for hardware packs and legs.**

## Chair





### Parts List

Label	Picture	Description	QTY
A	A line drawing of the chair's seat and backrest assembly, showing the slatted structure.	Chair Seat and Back	1
B	A line drawing of the chair's leg frame, showing the four legs and the armrest supports.	Chair Leg Frame	1

### Hardware

Label	Picture	Description	QTY
①	A line drawing of a bolt with a hexagonal head and a threaded shaft.	Bolt (M6x35mm)	5

②		Washer	5
③		Allen Key	1

## Assembly Preparation

### Before Beginning Assembly

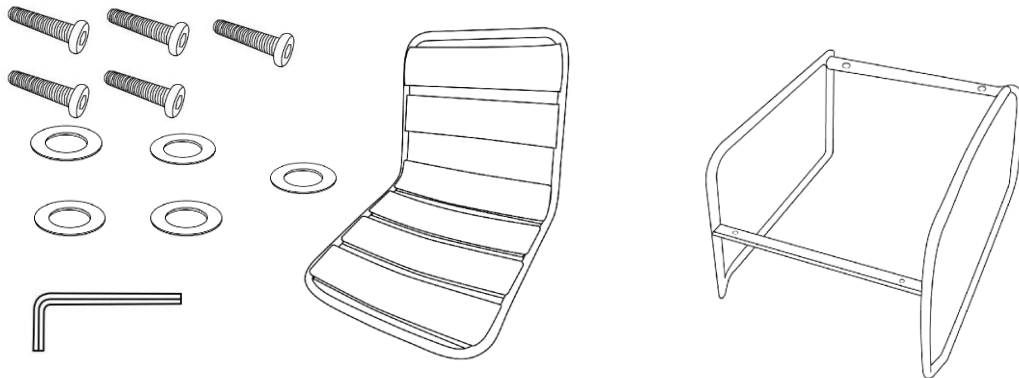

- Read instructions, cover to cover-



- Have 2 adults on hand for assembly-



- Do not assemble on flooring or carpet-



- Assemble on a clean non-marring surface (packing foam)-



- Save all packaging until finished-

## Assembly Steps

### Overview

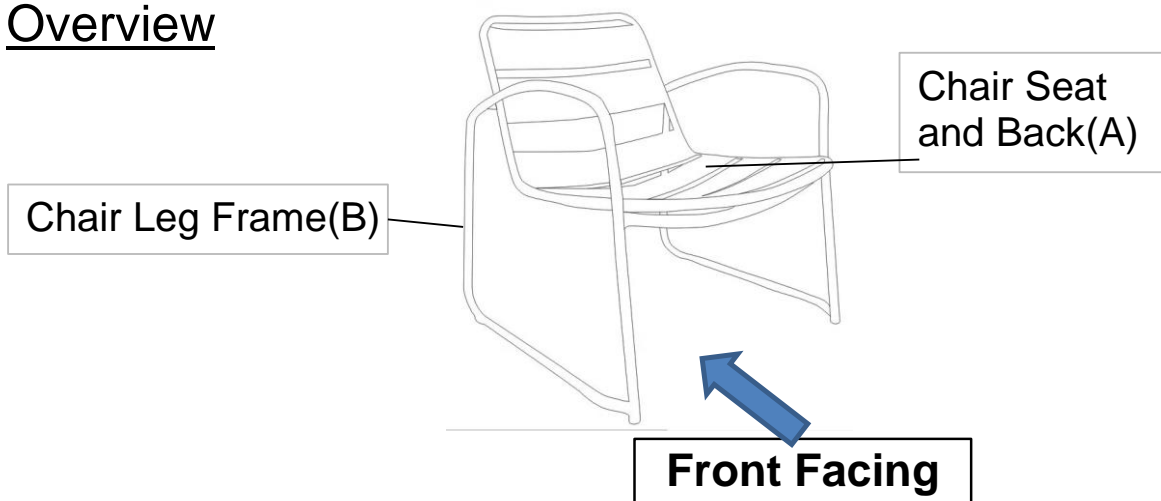

This Chair has multiple parts and may require up to 20 minutes to assemble. To give you an overview of the Chair parts, the above picture is provided to help you put the various parts into perspective. Please read through the instructions below to familiarise yourself with the parts and steps before assembly.

### Step 1

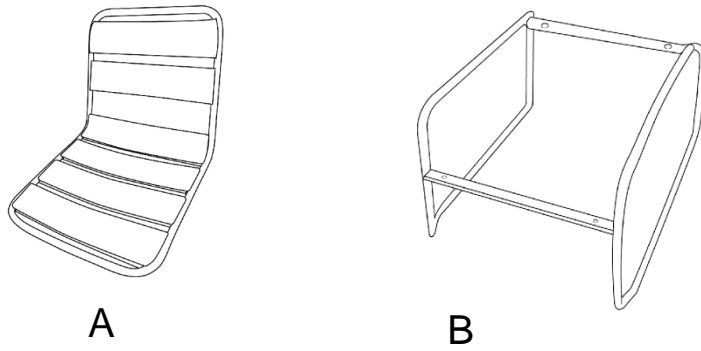

Unpack and place all parts on a clean, non-marring surface.

### Step 2

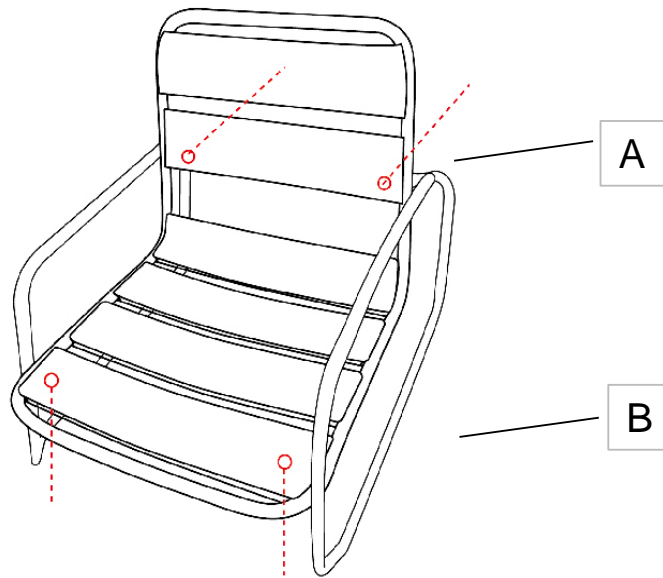

Place the Chair Seat and Back(A) on a clean, non-marring surface.  
Align the Chair Leg Frame(B) to Chair Seat and Back(A).

### Step 3

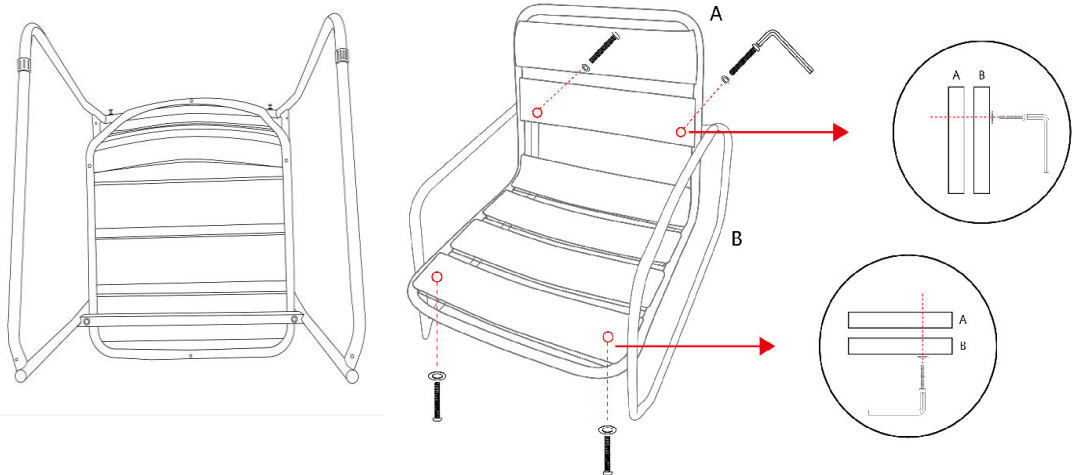

Attach Chair Leg (B) to Chair Seat and Back(A) with Bolts(①) and Washers (②) using the Allen Key (③).

**Do not fully tighten the Bolts.**

#### Step 4

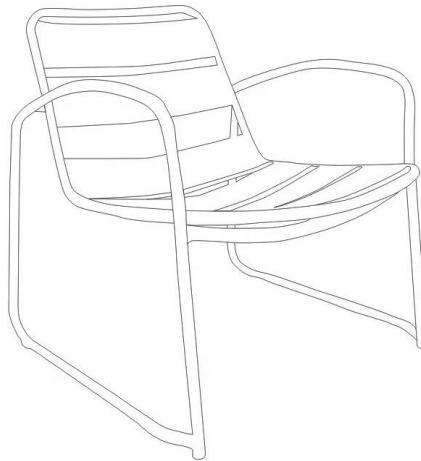

Turn the chair right side up.

Place the chair on a LEVEL SURFACE.

Inspect it and make sure all parts are adequately connected.

**Gently and carefully, sit into the chair.**

This will help align all the parts at all the joint areas.

Then get off the chair, and in a sequential manner, proceed to tighten all screws.

To tighten the Screws at the base of the Backrest, secure assistance from your adult partner(s).

You may be required to turn the chair, to gain easy access to the secure points.

Turn the chair in a synchronised manner.

**CAUTION 1: When tightening the screws, tighten sequentially.**

**DO NOT tighten any screw fully and then move on to the next one, as this could cause the frame to warp.**

**If the chair wobbles after tightening all screws, loosen the screws and repeat the same process.**



















**WARNING!! IF THE CHAIR IS NOT STABLE , IT COULD CAUSE THE PRODUCT TO BECOME DAMAGED.**

Ensure all screws are fully locked into position.

The chair is ready to be used.

**Caution 2: This chair should only be used on a flat, level surface.**

## Care & Maintenance

-   ● Do not put hot items directly on furniture surface
  -   ● Do not clean furniture with harsh cleansers or polish.
  -   ● To obtain the longest lifespan of your outdoor products, minimizing exposure to direct sunlight is recommended.
  -   ● Children should not climb or jump on the furniture.
  -   ● Do not write on furniture without a padded barrier to protect the surface.
  -   ● To obtain the longest lifespan of your outdoor products, avoid extended and lengthy exposure to rain, snow, and direct sunshine. Whenever possible cover the product and /or place under patio or awnings.
  -   ● Not for commercial use. For residential use only .
  -   ● Stains may be removed with mild soap solution and damp cloth.
- 
-   ● Dust and pick-up spills using a clean, non-colored, lint-free cloth .

# Assembly Instructions

**Caution : Please read this carefully before you proceed**

**Please look in Red Bag for hardware packs and legs.**





## Table



## Parts List

Label	Picture	Description	QTY
A		Table Top	1
B		Table leg	2
C		Support Rod	1

# Hardware

Label	Picture	Description	QTY
①		Bolt (M6x14mm)	5
②		Bolt (M6x30mm)	3
③		Allen Key	1
④		Washer	5

# Assembly Preparation

**Before Beginning Assembly**

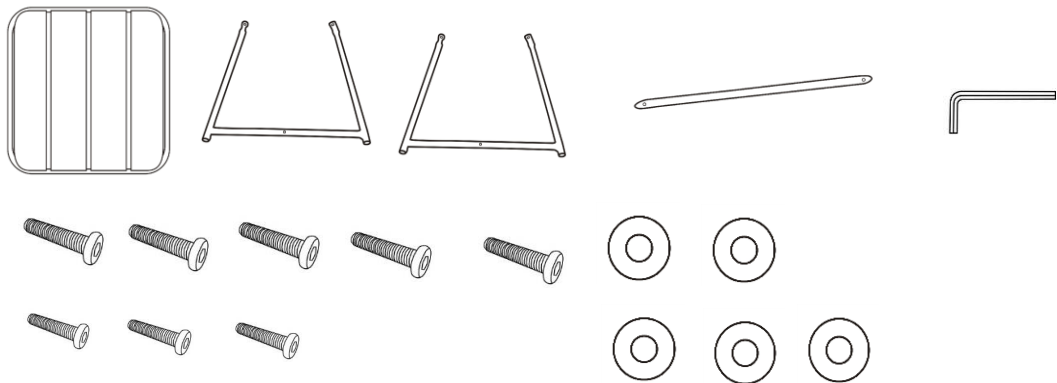

- Read instructions, cover to cover-



- Have 2 adults on hand for assembly-



- Do not assemble on flooring or carpet-



- Assemble on a clean non-marring surface (packing foam)-



- Save all packaging until finished-

# Assembly Steps

## Overview

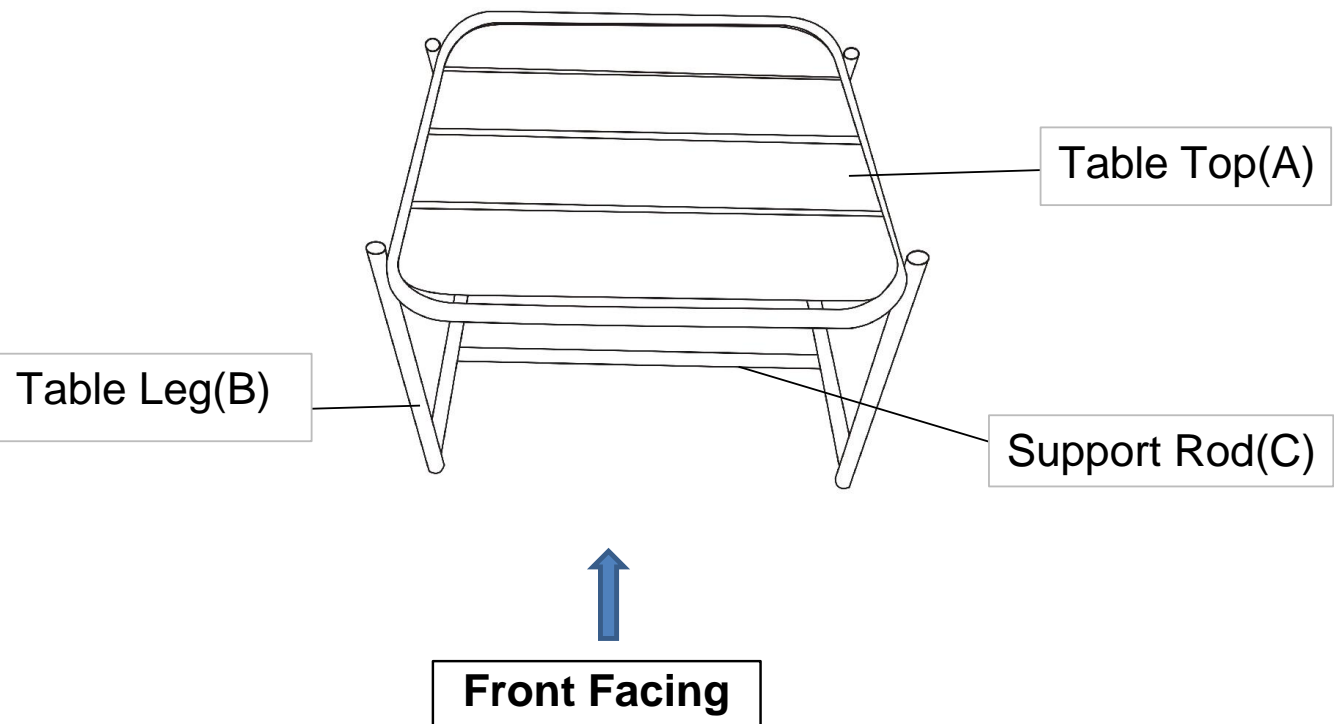

This Table has multiple parts and may require up to 20 minutes to assemble. To give you an overview of the Table parts, the above picture is provided to help put the various parts into perspective. Please read through the instructions below to familiarise yourself with the parts and steps before assembly.

## Step 1

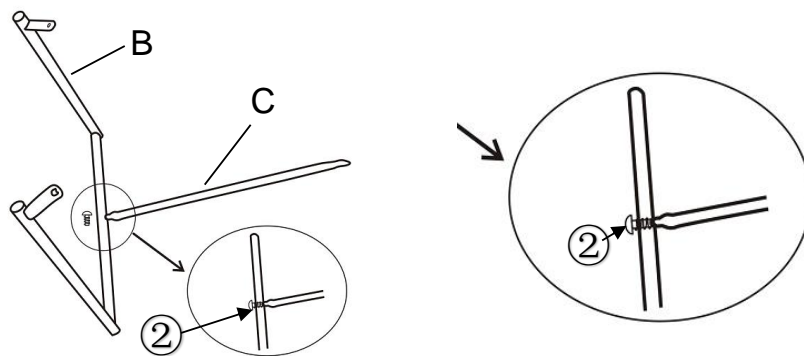

Attach the Support Rod (C) to Table Leg (B), with Bolts(②) using the Allen Key (③).

## Step 2

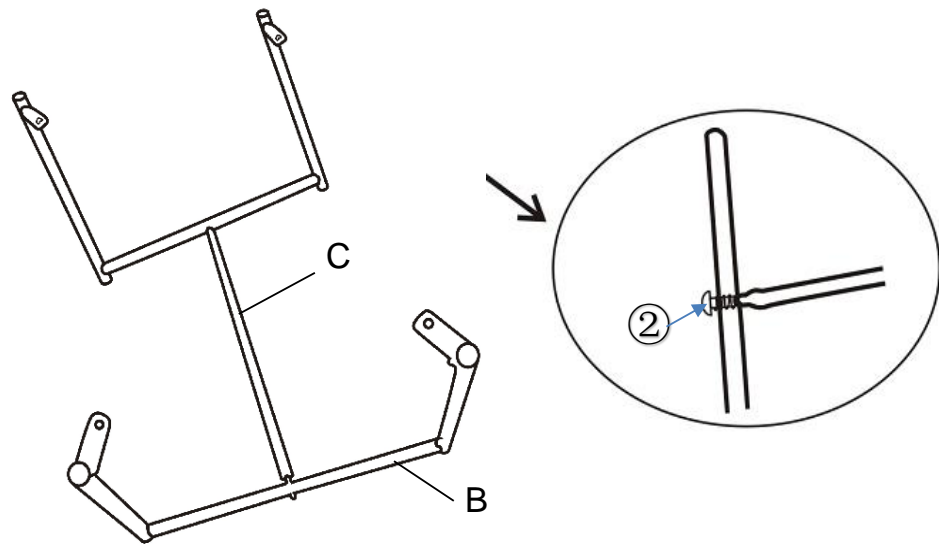

Attach the Support Rod (C) to Table Leg (B) with Bolts(②) using the Allen Key (③).

## Step 3

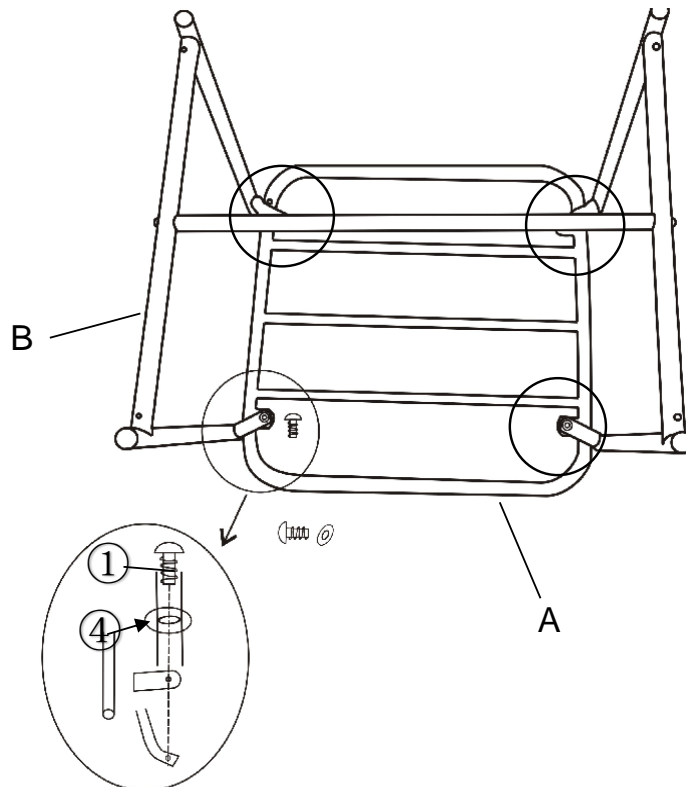

Attach Table Leg (B) to Table Top (A) with Bolts(①) and Washers (④) using the Allen Key (③).

**Do not fully tighten the Bolts.**

## Step 4

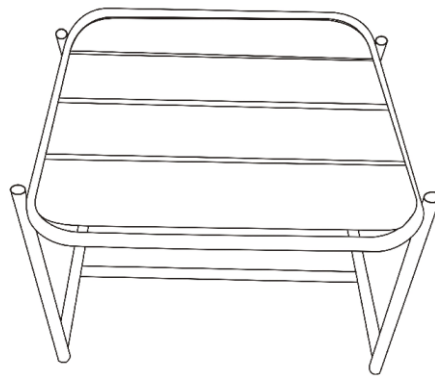

Place the side table on a **LEVEL SURFACE**.

Inspect it and make sure all parts are adequately connected, then proceed to tighten the screws in a sequential manner.



















**CAUTION 1:** When tightening these screws, tighten sequentially. **DO NOT** tighten any screw fully and then move on to the next one, as this could cause the frame to warp.

Ensure all screws are fully locked into position.

The table is ready to be used.

**Caution 2:** This table should only be used on a flat, level surface.

## Care & Maintenance

-   ● Do not put hot items directly on furniture surface
  -   ● Do not clean furniture with harsh cleansers or polish.
  -   ● To obtain the longest lifespan of your outdoor products, minimizing exposure to direct sunlight is recommended.
  -   ● Children should not climb or jump on the furniture.
  -   ● Do not write on furniture without a padded barrier to protect the surface.
  -   ● To obtain the longest lifespan of your outdoor products, avoid extended and lengthy exposure to rain, snow, and direct sunshine. Whenever possible cover the product and /or place under patio or awnings.
  -   ● Not for commercial use. For residential use only .
  -   ● Stains may be removed with mild soap solution and damp cloth.
- 
-   ● Dust and pick-up spills using a clean, non-colored, lint-free cloth .