

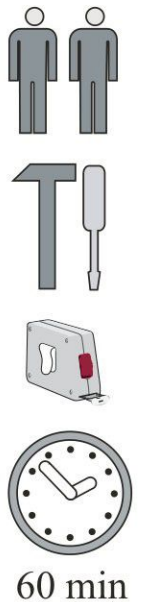

















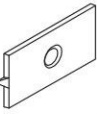
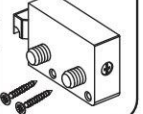

NO	Dim			Col.-No	Qty
1	412	380	16	1	1
2	412	380	16	1	1
4	500	380	16	1	1
5	466	360	16	1	1
3	500	380	16	1	1
8	350	140	16	1	1
9	350	140	16	1	1
10	409	120	16	1	1
6	501	84	16	1	1
7	496	220	16	1	1
11	354	421	3	1	1
13	478	228	3	1	1
12	478	194	3	1	1

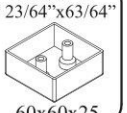
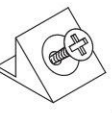
NO	Inch			Col.-No	Qty
1	16 7/32	14 61/64	5/8	1	1
2	16 7/32	14 61/64	5/8	1	1
4	19 11/16	14 61/64	5/8	1	1
5	18 11/32	14 11/64	5/8	1	1
3	19 11/16	14 61/64	5/8	1	1
8	13 25/32	5 33/64	5/8	1	1
9	13 25/32	5 33/64	5/8	1	1
10	16 7/64	4 23/32	5/8	1	1
6	19 23/32	3 5/16	5/8	1	1
7	19 17/32	8 21/32	5/8	1	1
11	13 15/16	16 37/64	1/8	1	1
13	18 13/16	8 31/32	1/8	1	1
12	18 13/16	7 41/64	1/8	1	1

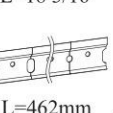

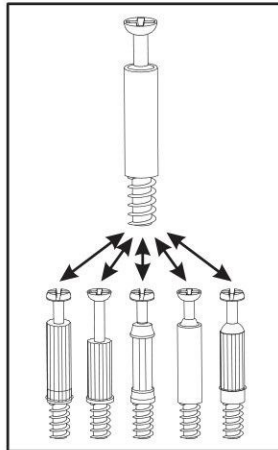
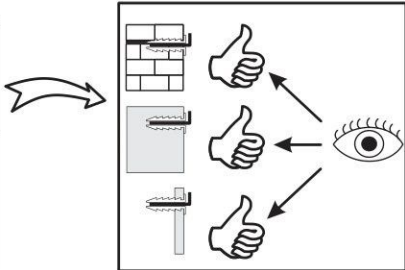
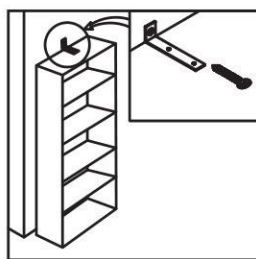
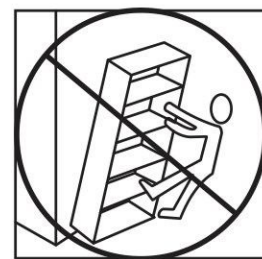
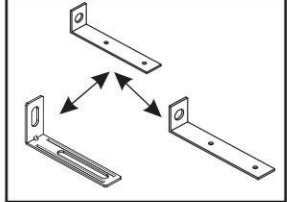
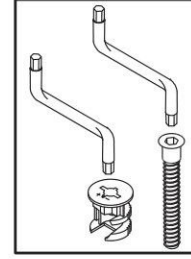
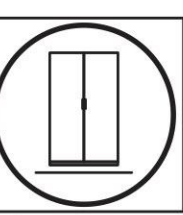
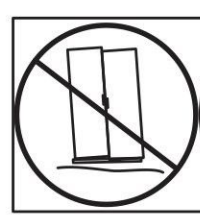
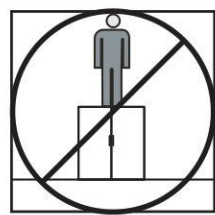
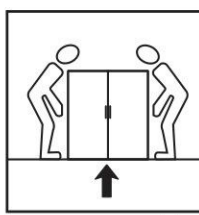
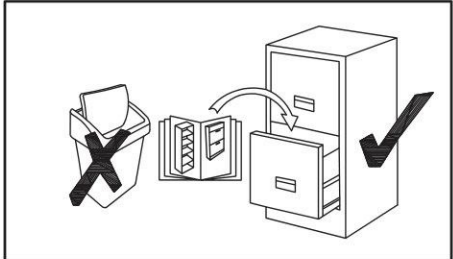
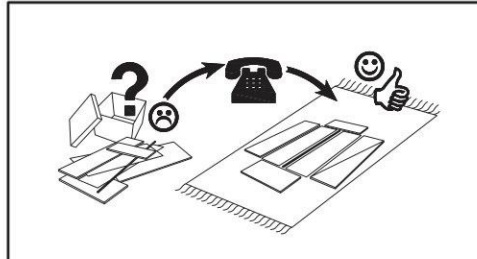
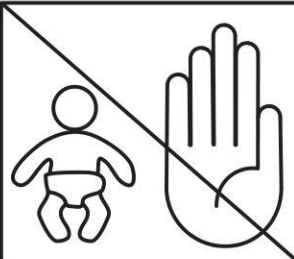
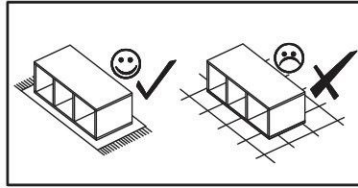
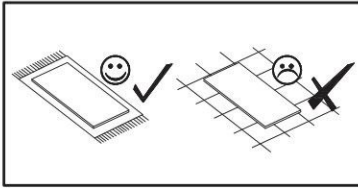
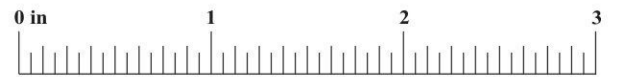
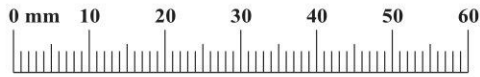

A1 x18  ø8x36	B11 x8  ø9/32"x1 31/32" ø7x50	G4 x8  C	B4 x12 	B5 x12  ø19/32"x15/32" ø15x12	G5 x12 
D20 x4  ESØ15/64"x3/8" ESØ6x9,5	UP13 x6  USØ1/8"x5/8" UPØ3x16	D10 x4  USØ9/64"x33/64" USØ3,5x13	G16 x3 	ZXL x1 	ZXP x1 
D6 x8  USØ9/64"x1 3/16" USØ3,5x30	H5 x1  L-13 25/32" L-350mm.	ST21 x4  2 23/64"x 2 23/64"x63/64" 60x60x25	S1 x9 	KR5 SFXP x4  ø 25/64"/1 31/32 x2 23/64 ø10/50x60	SZ9 x1  L=18 3/16" L=462mm
LZ3 x1 	SQ x1 	G2 x1 			





1

A1	Ø5/16" x 1 27/64"
x4	 ø8x36

B5	Ø19/32" x 15/32"
x2	 Ø15x12

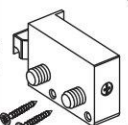
B4	
x2	

ZXL	
x1	

D20	ESØ15/64" x 3/8"
x2	 ESØ6x9,5

H5	
x1	L-350mm.

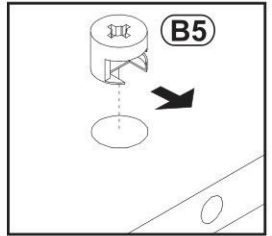
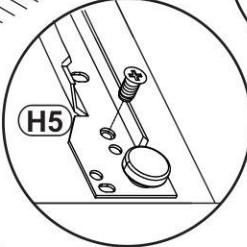
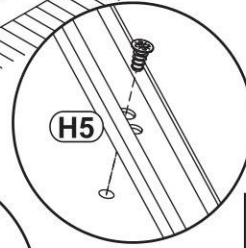
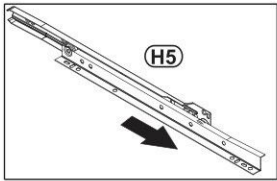
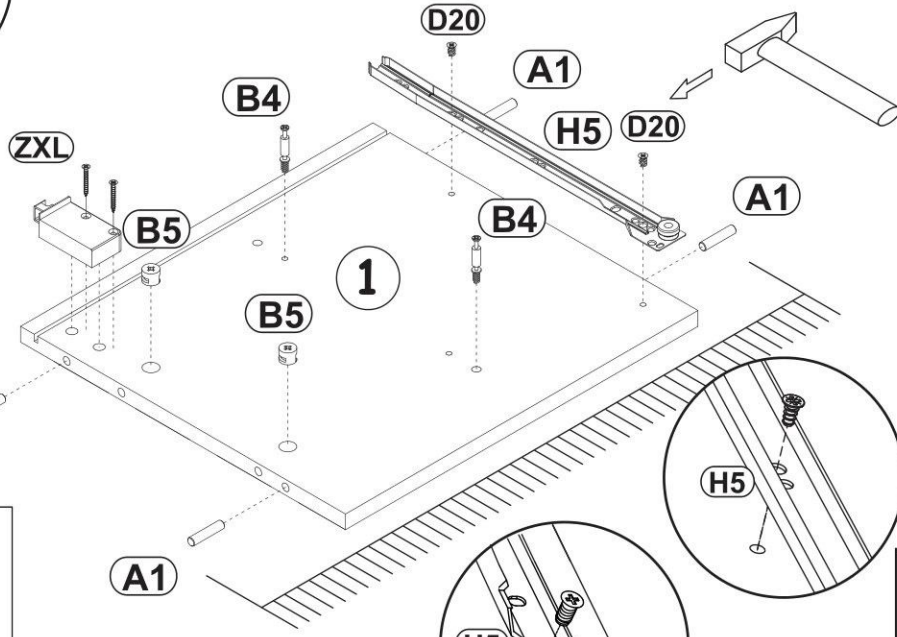
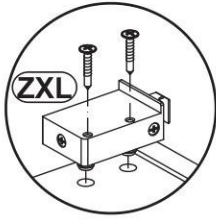

2

A1	Ø5/16" x 1 27/64"
x4	 ø8x36

B5	Ø19/32" x 15/32"
x2	 Ø15x12

B4	
x2	

ZXP	
x1	

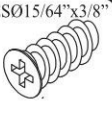
D20	ESØ15/64" x 3/8"
x2	 ESØ6x9,5

H5	
x1	L-350mm.

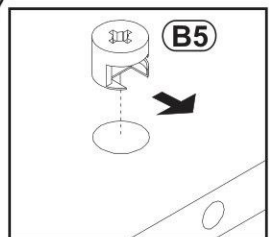
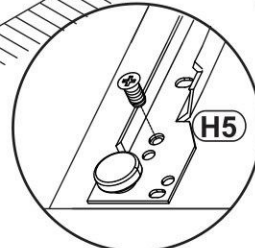
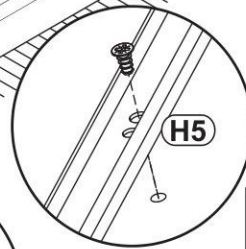
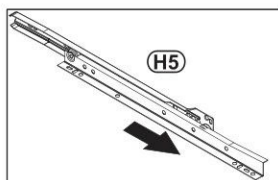
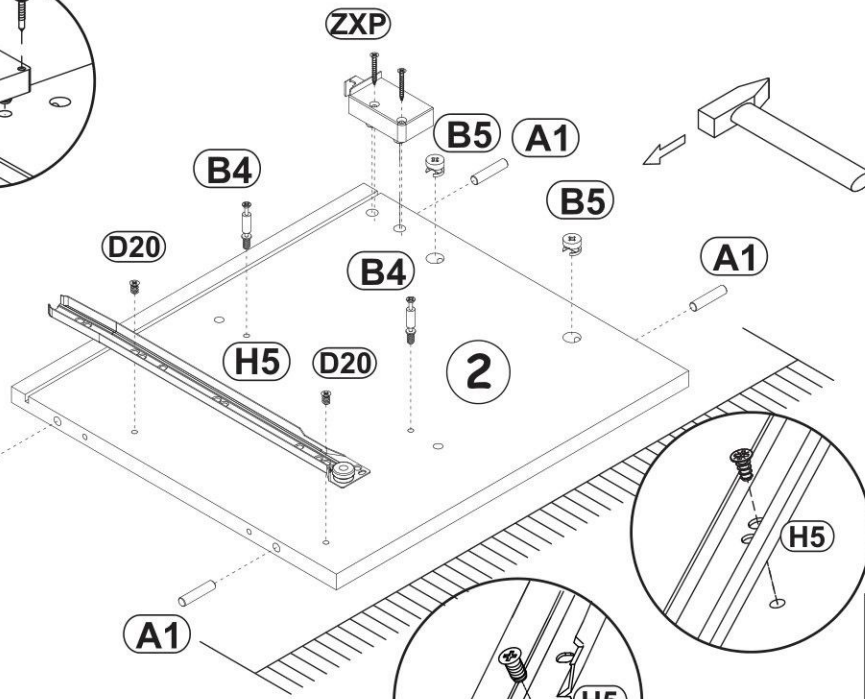
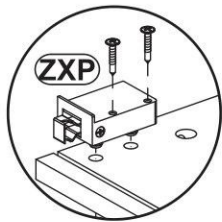
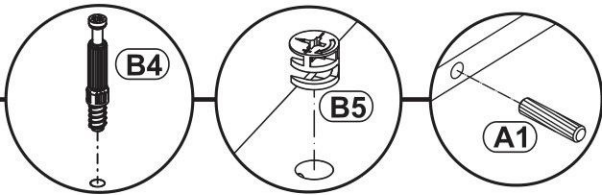

3

A1	Ø5/16"x1 27/64"
x2	 ø8x36

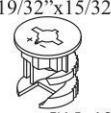
B5	Ø19/32"x15/32"
x2	 Ø15x12

B4	
x4	

SQ	
x1	

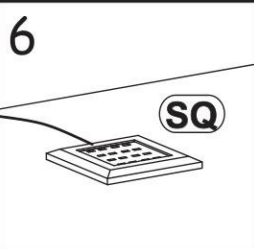
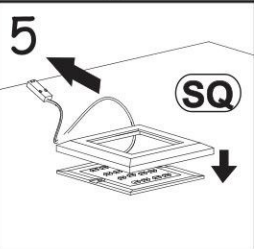
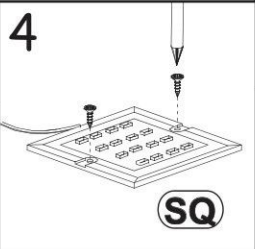
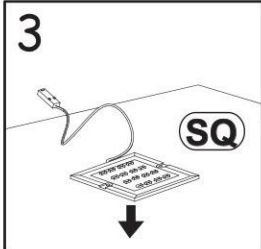
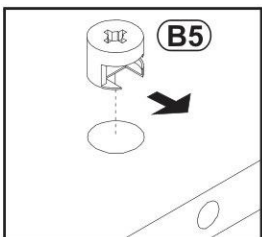
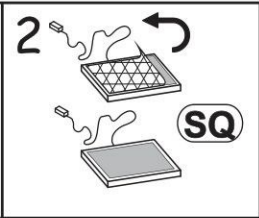
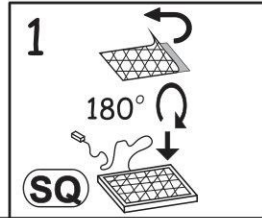
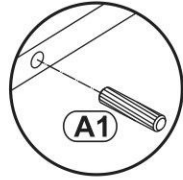
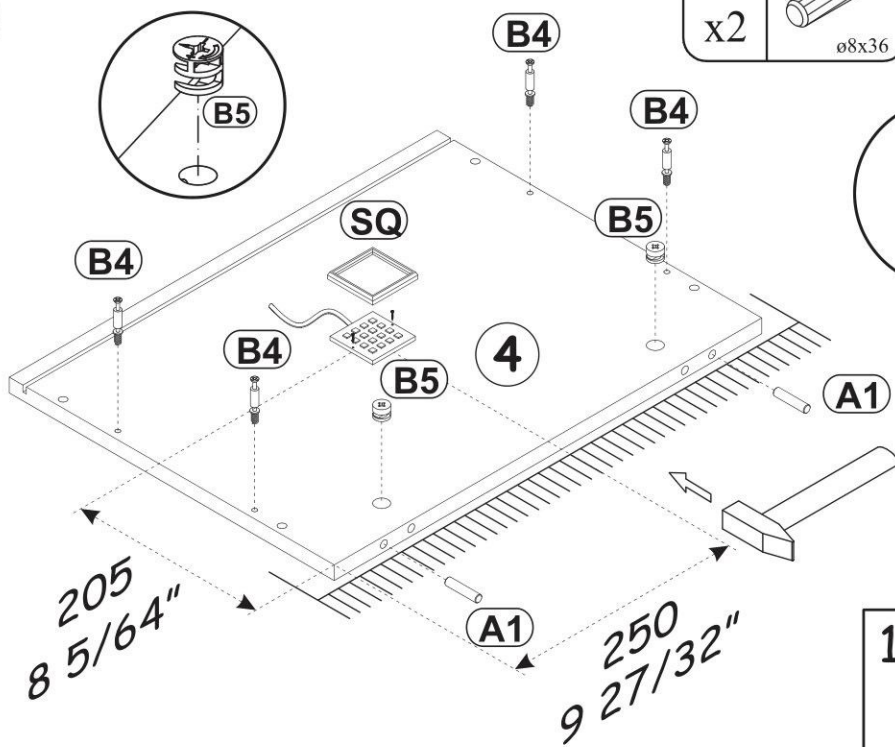

4

A1	Ø5/16"x1 27/64"
X4	 ø8x36

B5	Ø19/32"x15/32"
x4	 Ø15x12

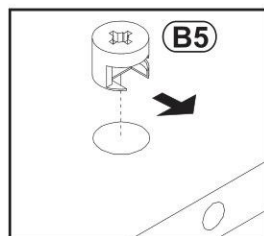
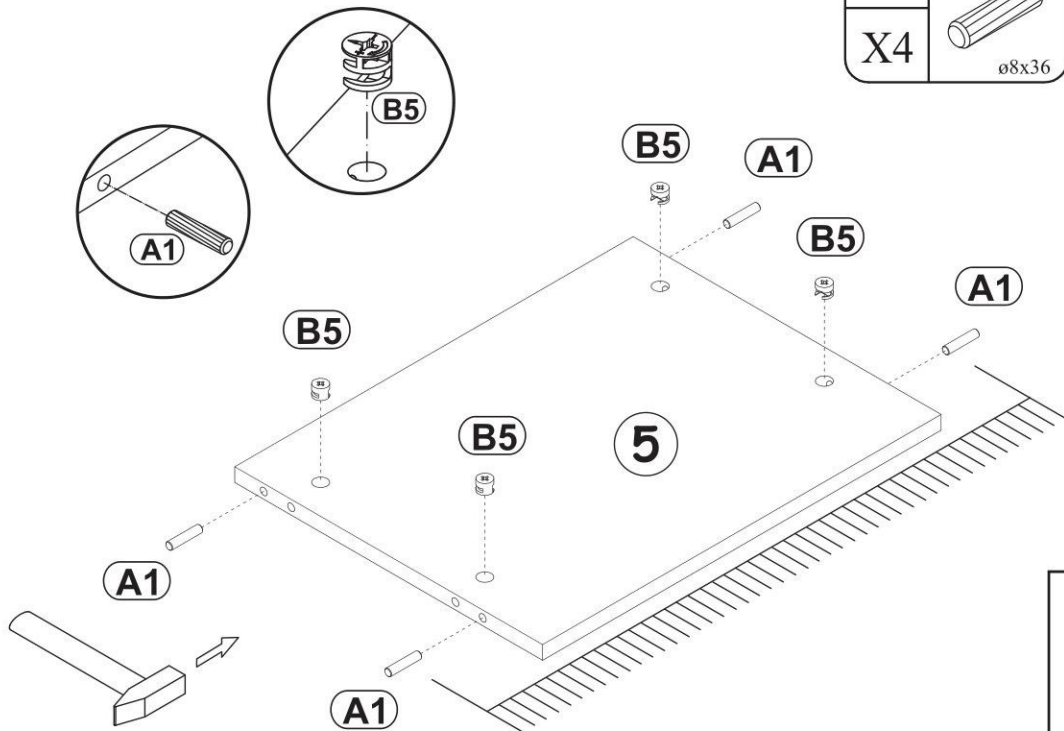

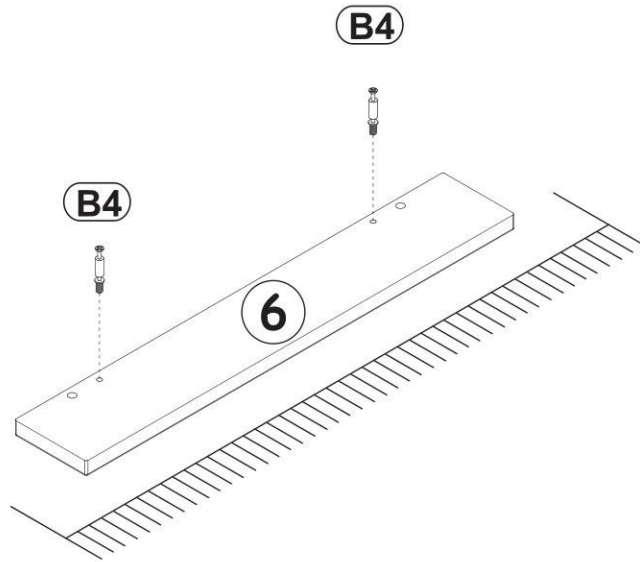

5

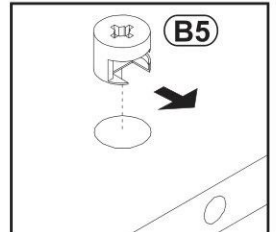
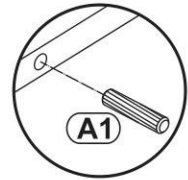
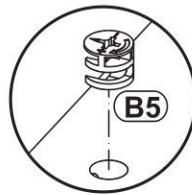
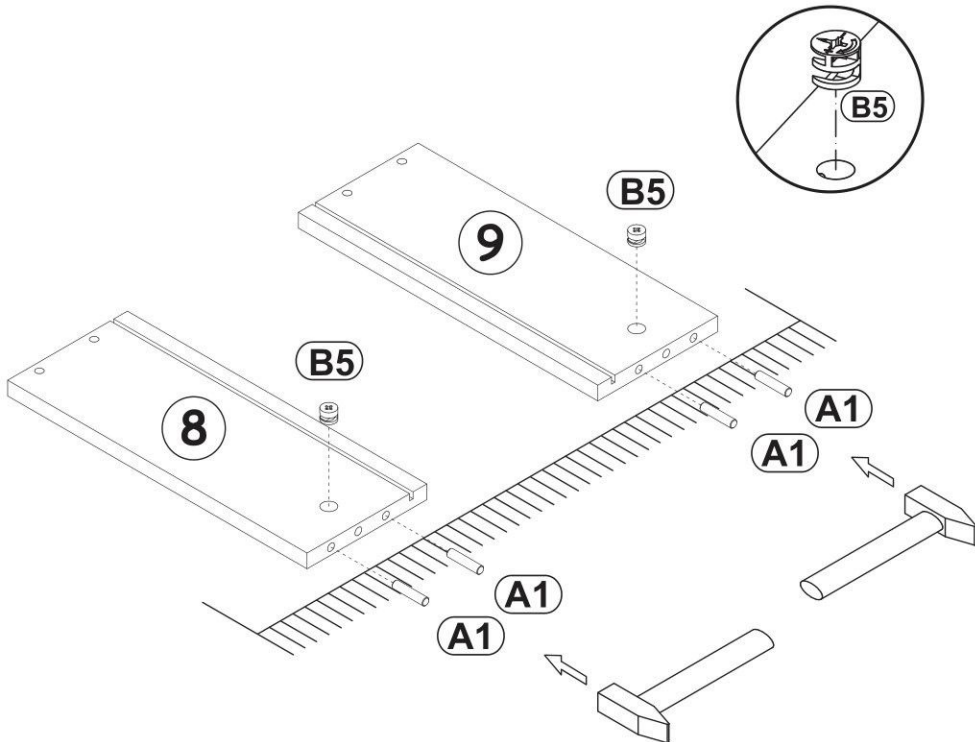

B4	
x2	

6



B5	$\phi 19/32'' \times 15/32''$ 
x2	$\phi 15 \times 12$

A1	$\phi 5/16'' \times 1 27/64''$ 
x4	$\phi 8 \times 36$

7

B4

x2

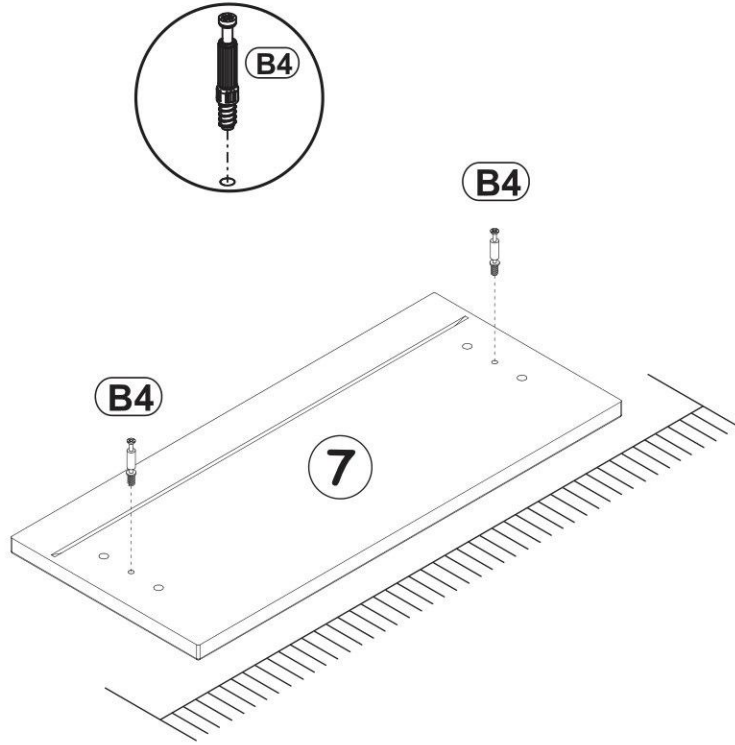

8

G5

x2

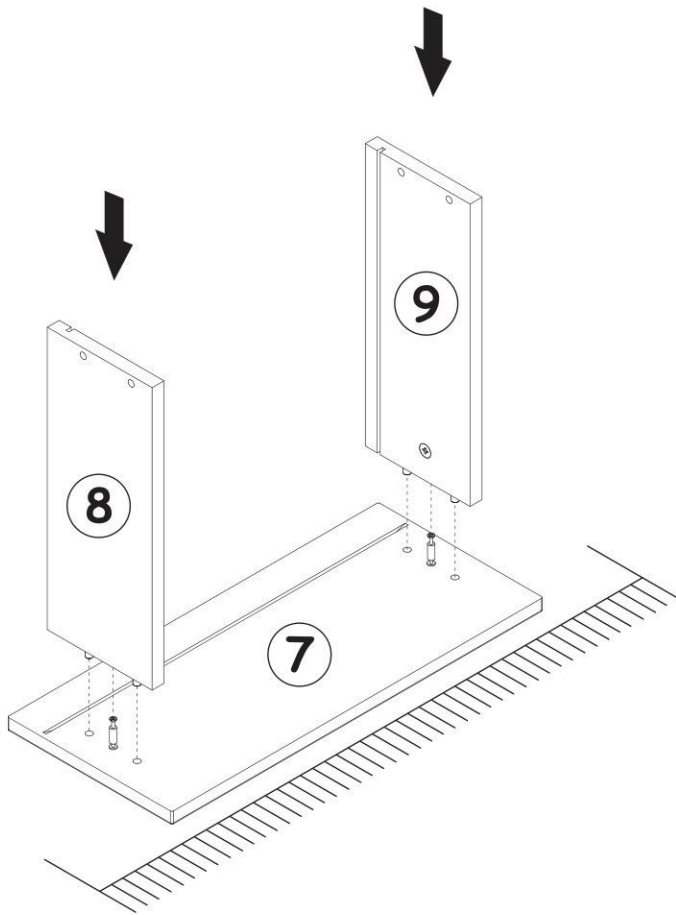
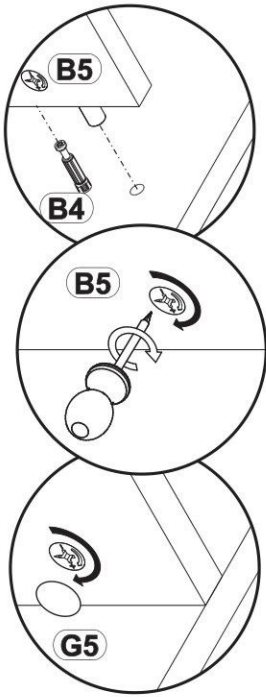

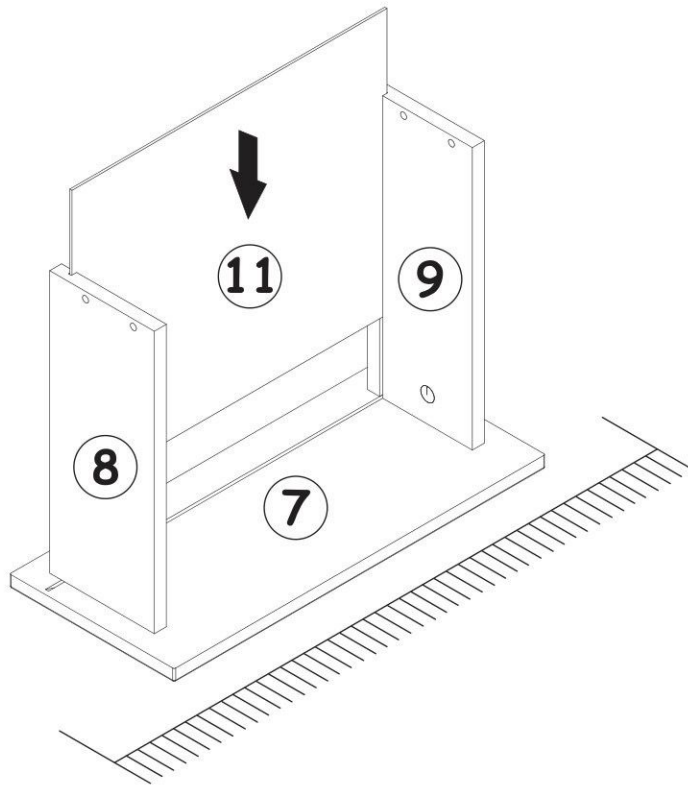

9

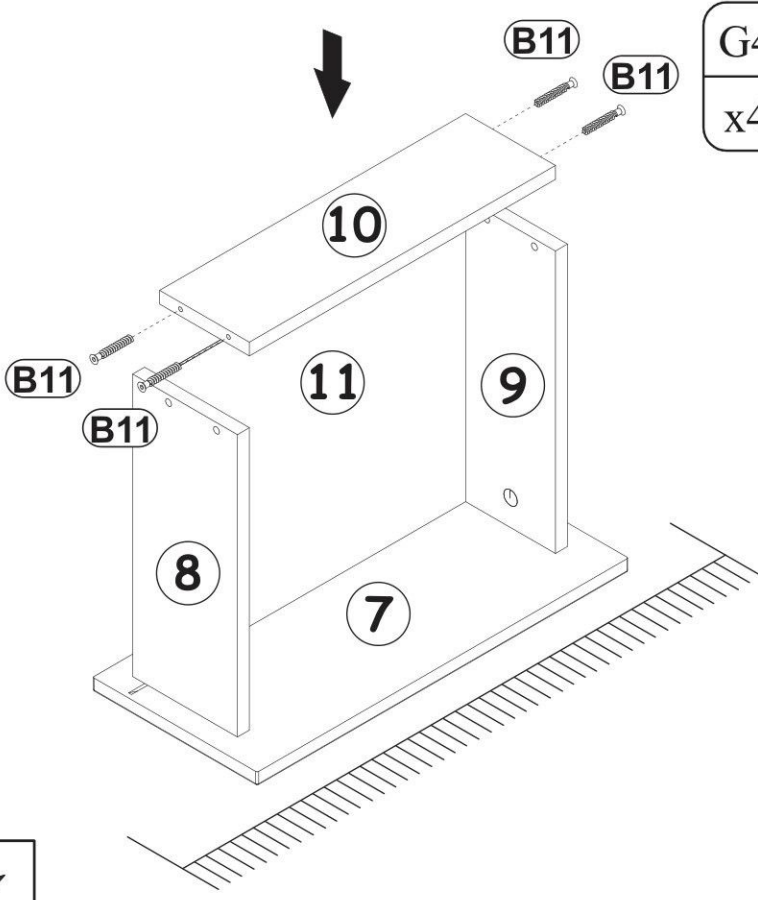

10



G4	
x4	c

B11	Ø9/32"x1 31/32"
x4	
	Ø7x50

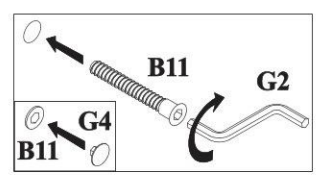
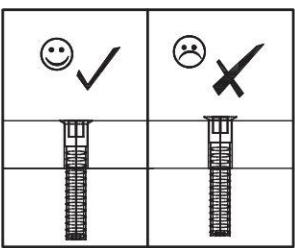

11

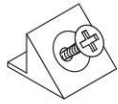
S1		UP13	US01/8"x5/8"
x1		x3	UP03x16

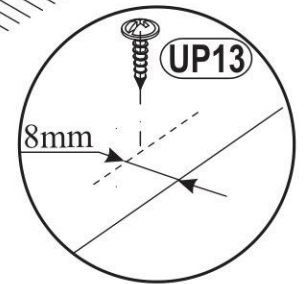
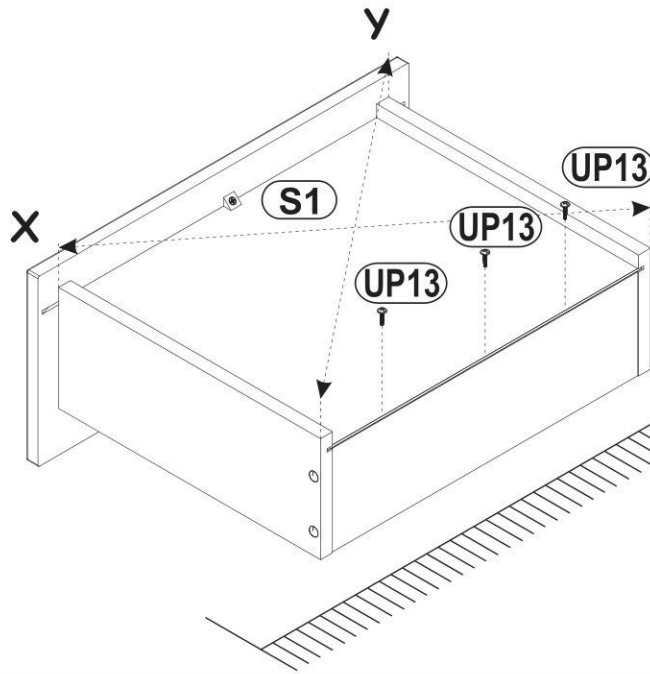
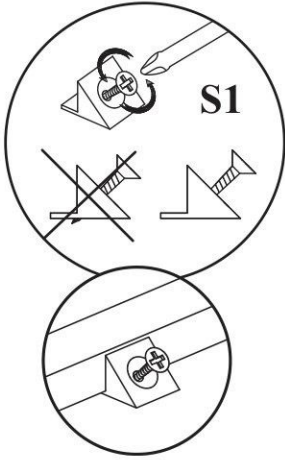

12

H5	L-13 25/32"	D10	US09/64"x33/64"
x1	L-350mm.	x4	US03,5x13

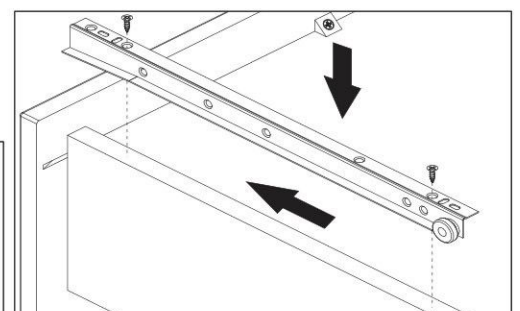
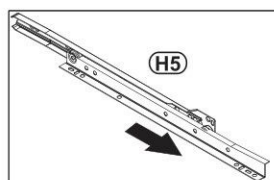
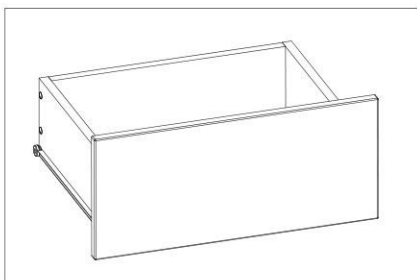
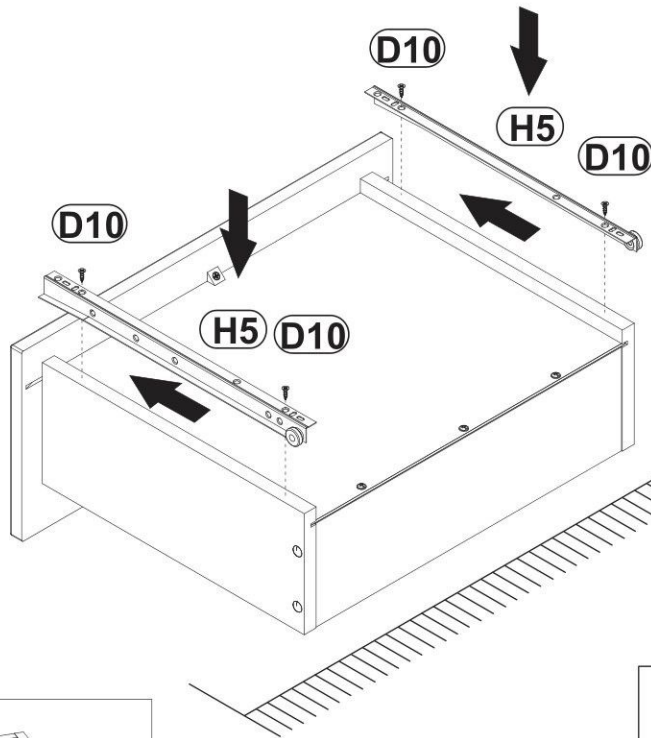

13

G5	
x4	

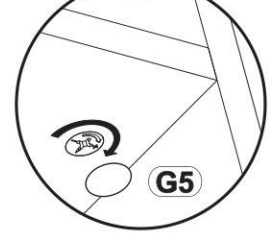
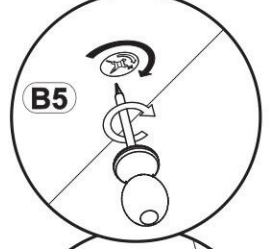
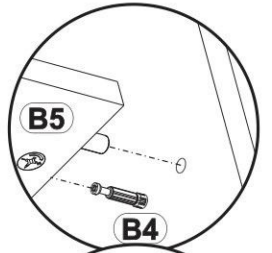
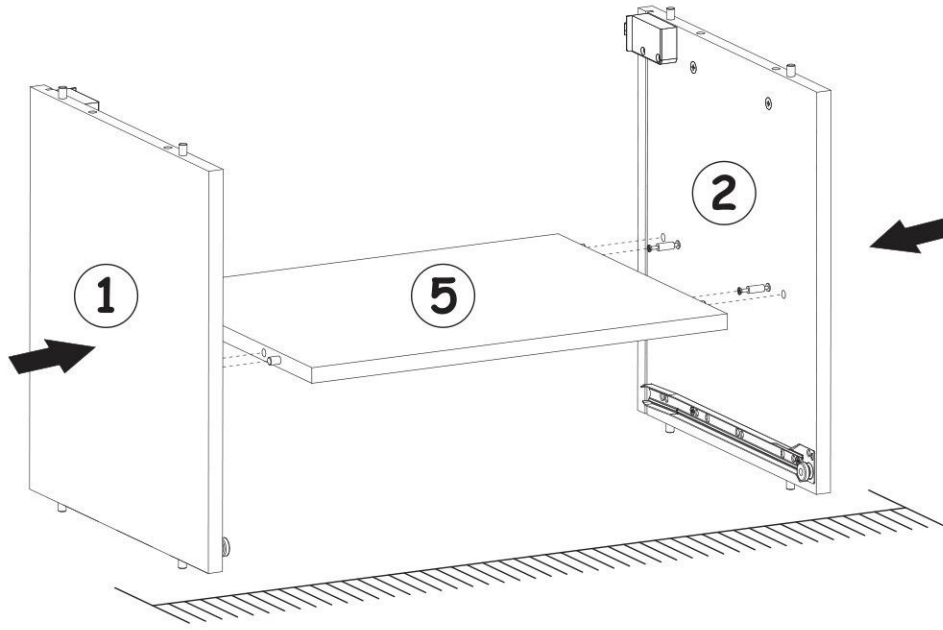

14

G5	
x4	

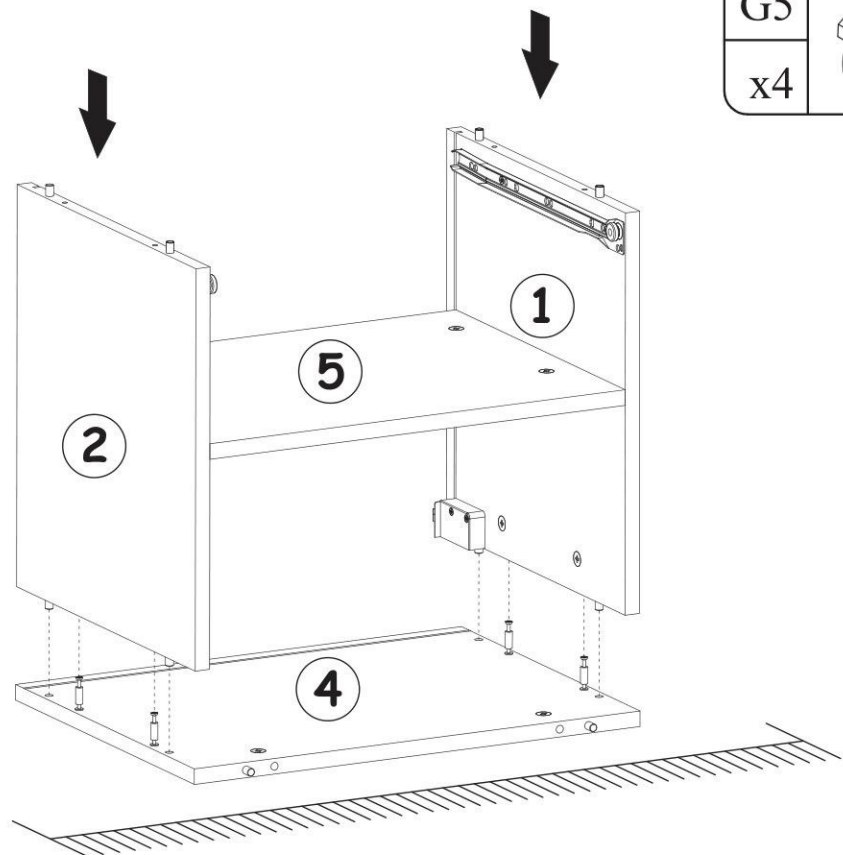
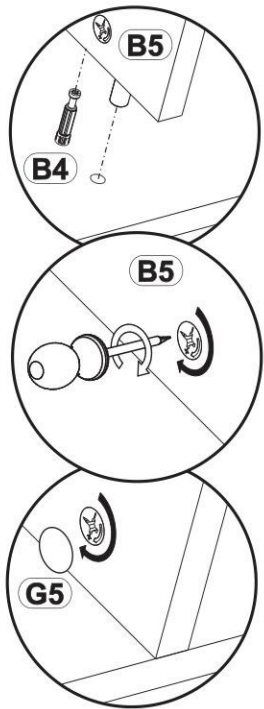

15

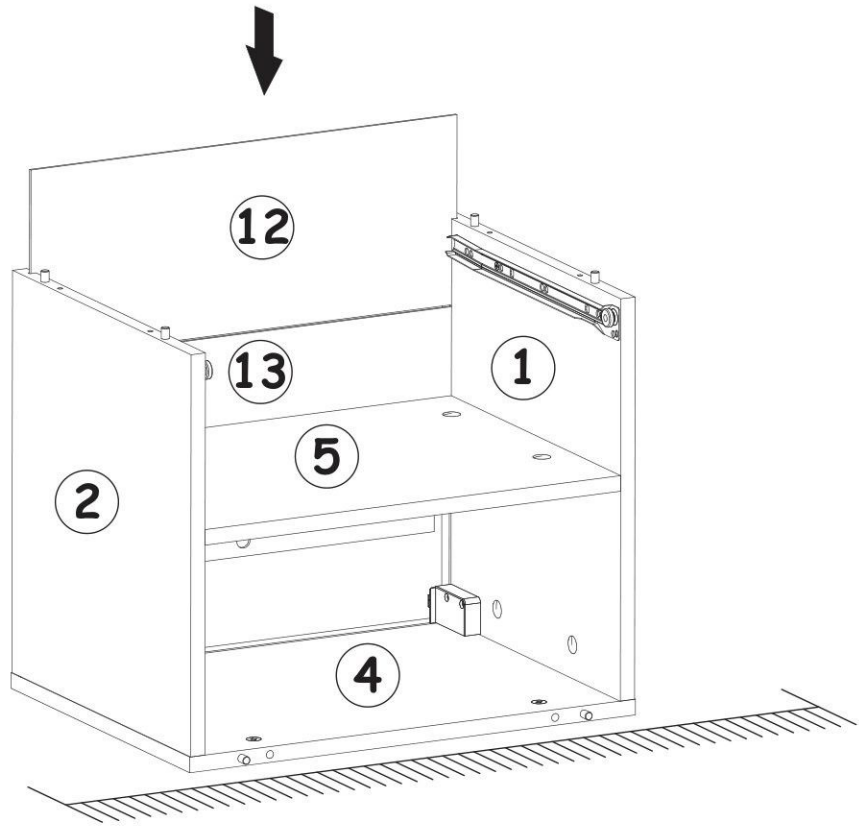

16

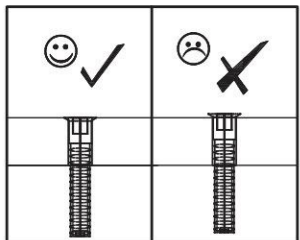
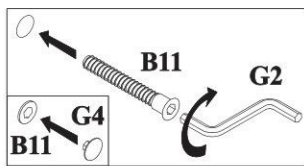
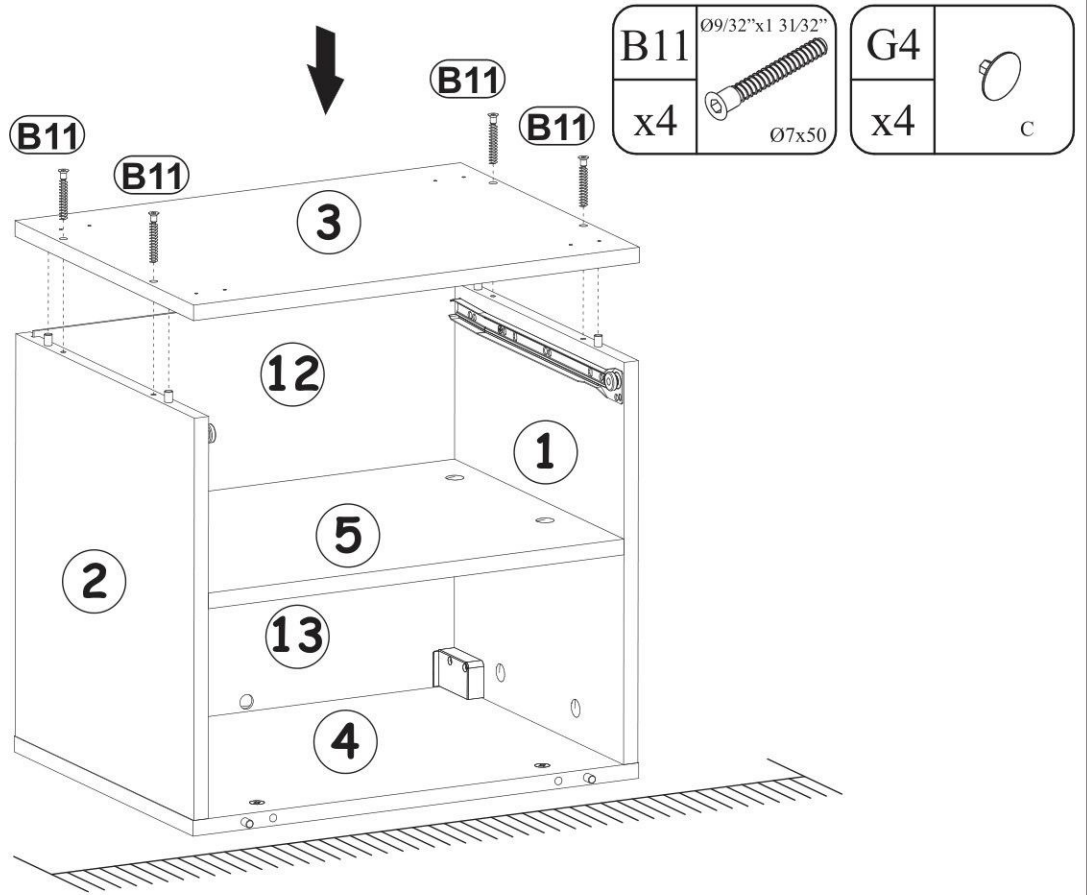

17

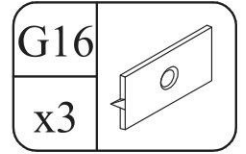
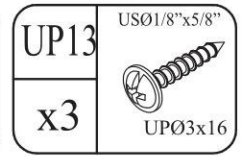
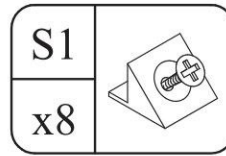
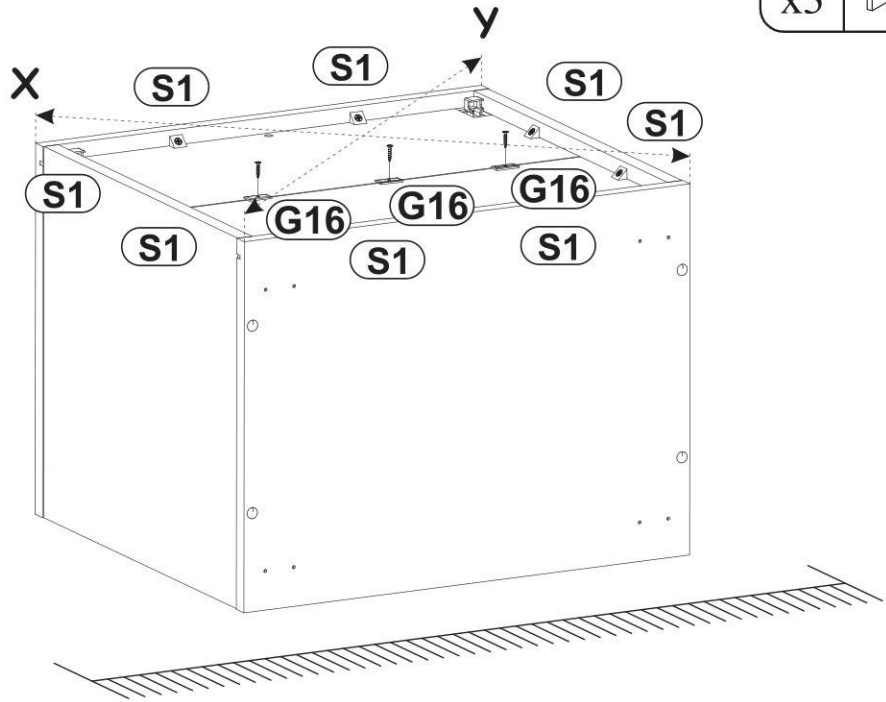
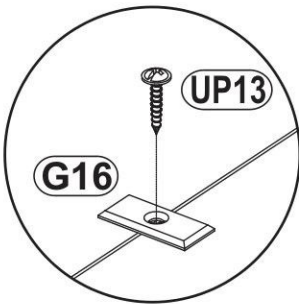
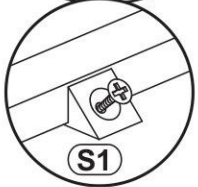
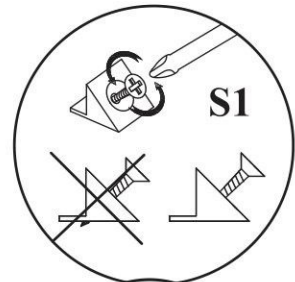

18

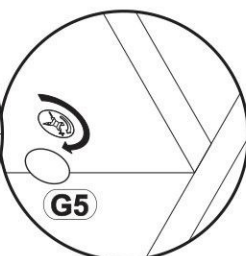
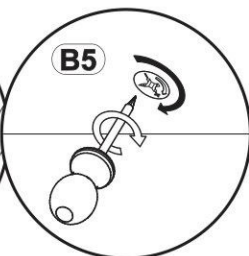
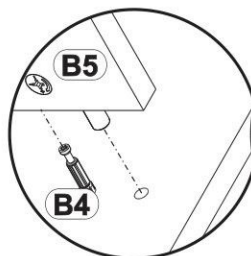
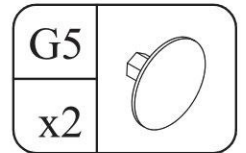
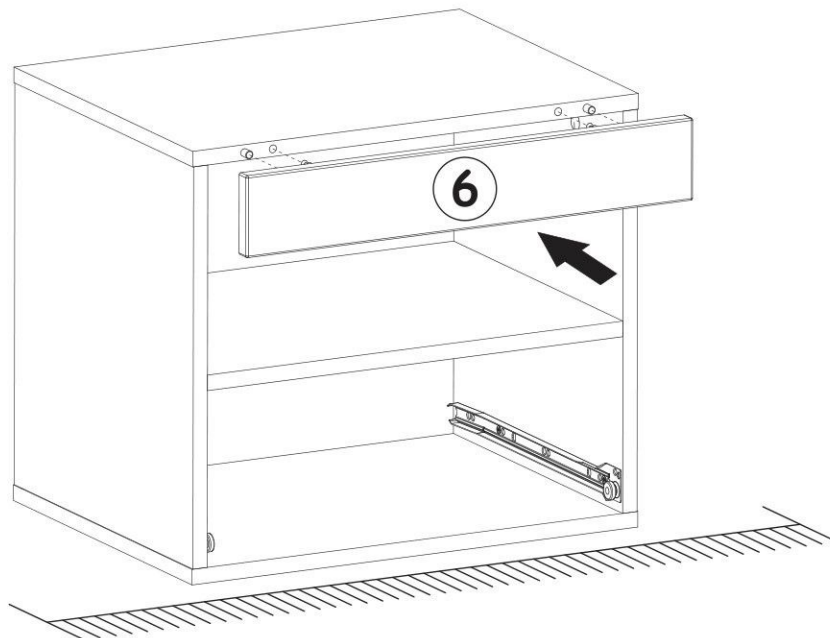

FLOOR STANDING OPTION ONLY!



19 - 21

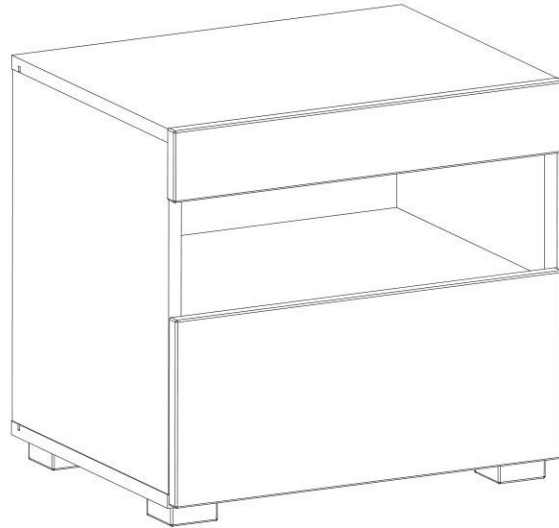

WALL MOUNTED OPTION ONLY!

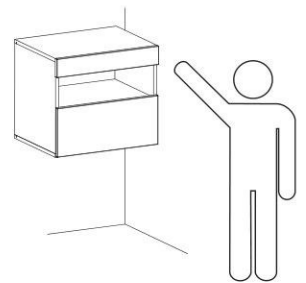

22 - 24

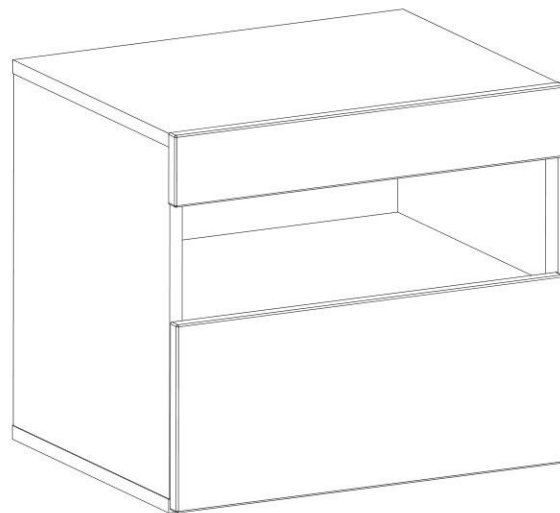

19

D6	US09/64"x1 3/16"	ST21	2 23/64"x 2 23/64"x63/64"
x8	USØ3,5x30	x4	60x60x25

FLOOR STANDING OPTION ONLY!

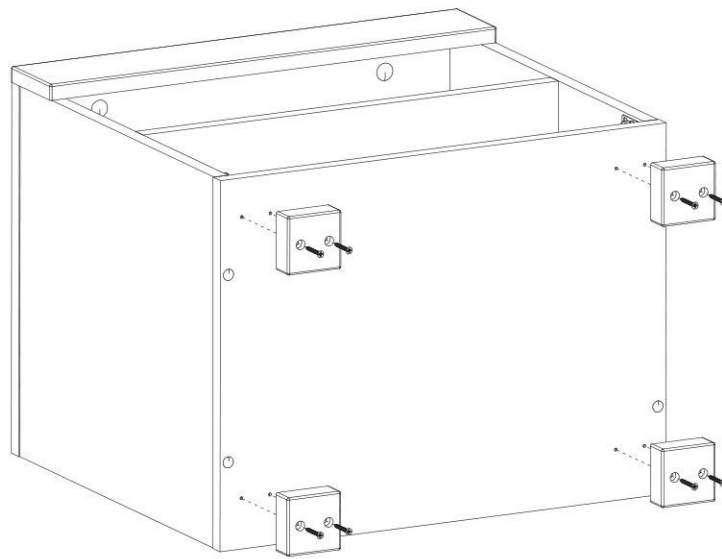
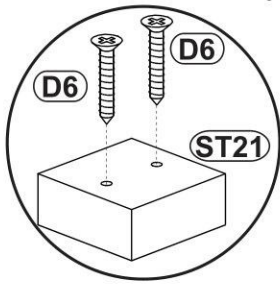

20

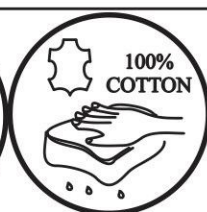
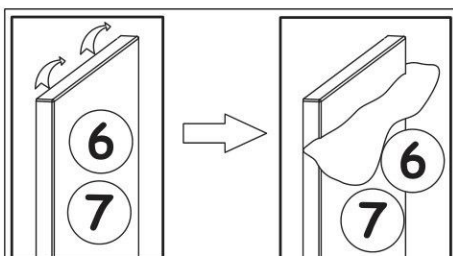
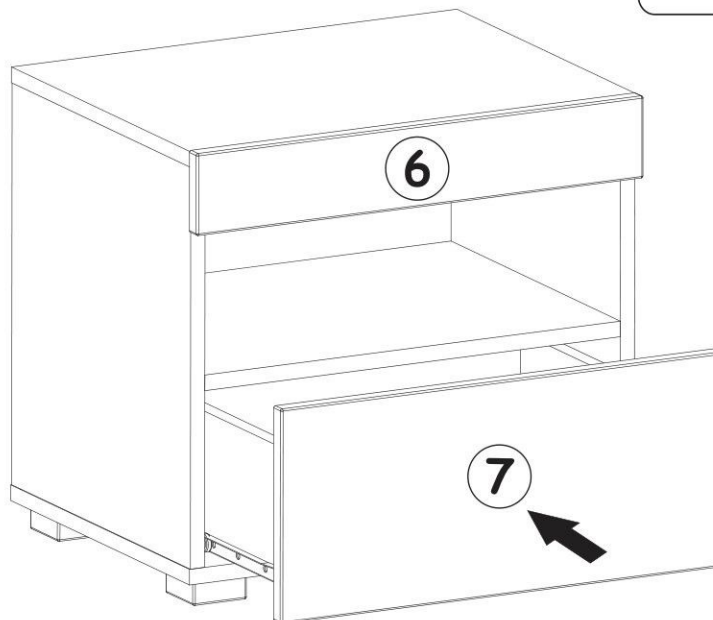
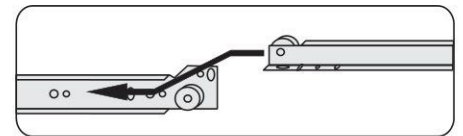

21

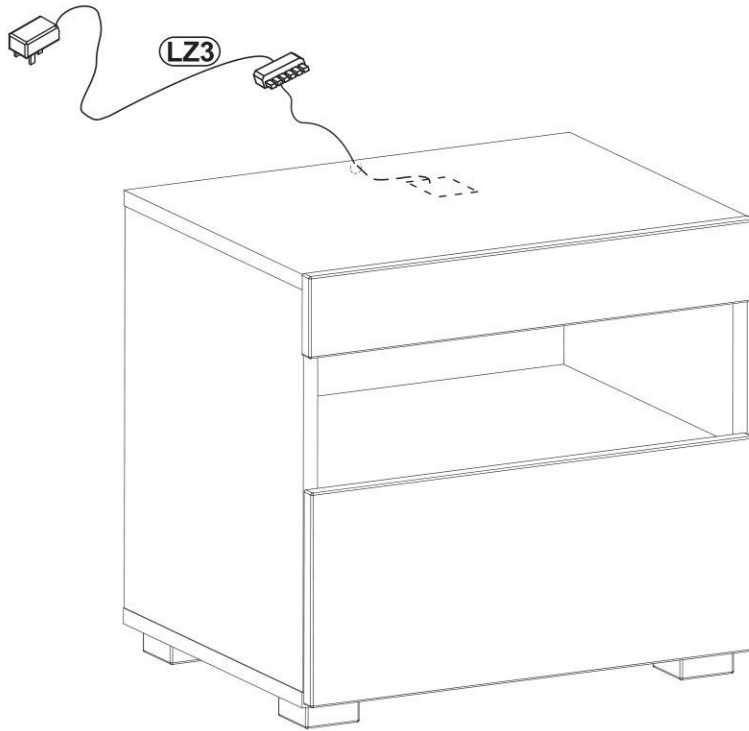

LZ3	
x1	

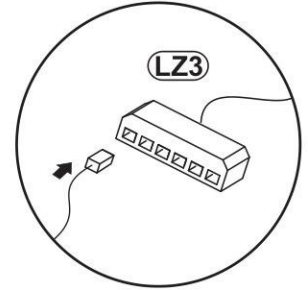

22 WALL MOUNTED OPTION ONLY!

KR5	
SFXP	
x4	

$\varnothing 25/64'' \times 1 31/32$ $\times 2 23/64$	
$\varnothing 10/50 \times 60$	

SZ9	L=18 3/16''
x1	
	L=462mm

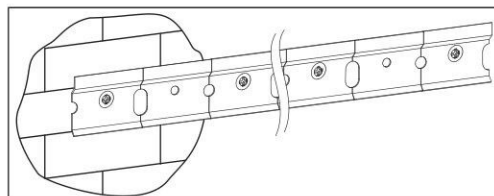
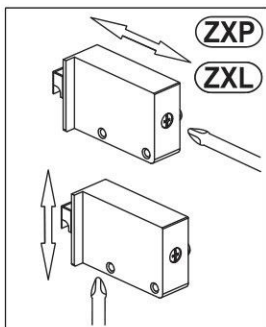
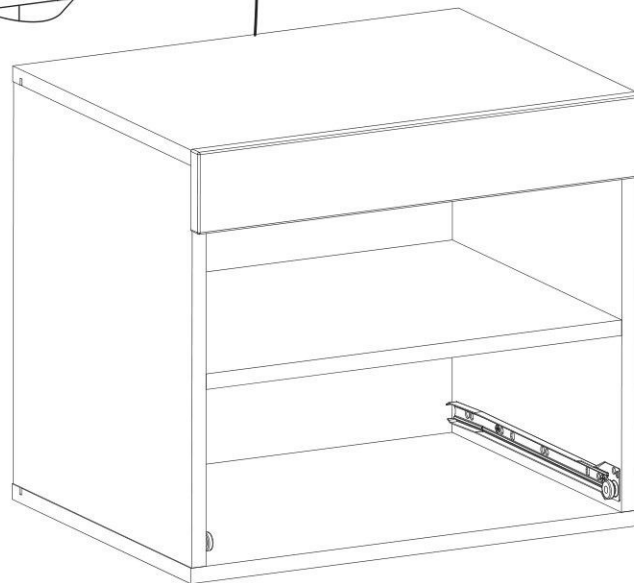
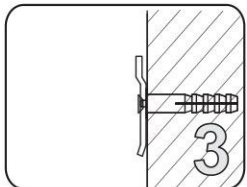
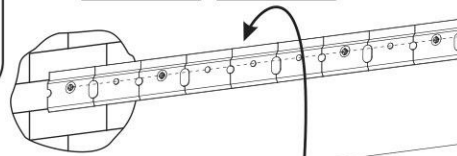
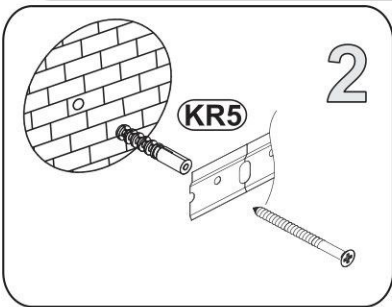
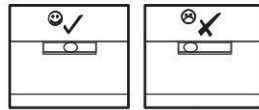
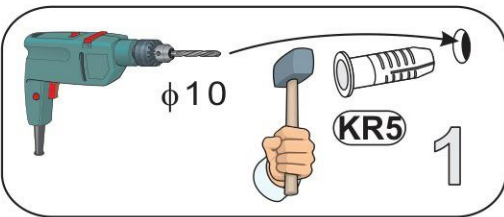

23

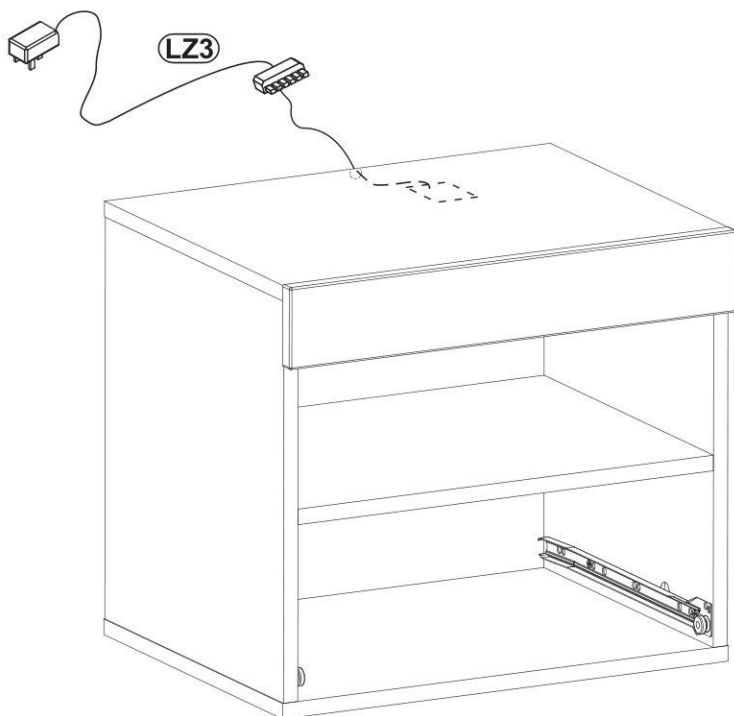

LZ3	
x1	

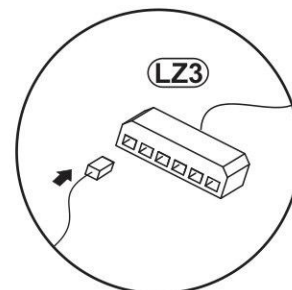

24

