

ASSEMBLY INSTRUCTION
BUNK BED
SKU : BW00146

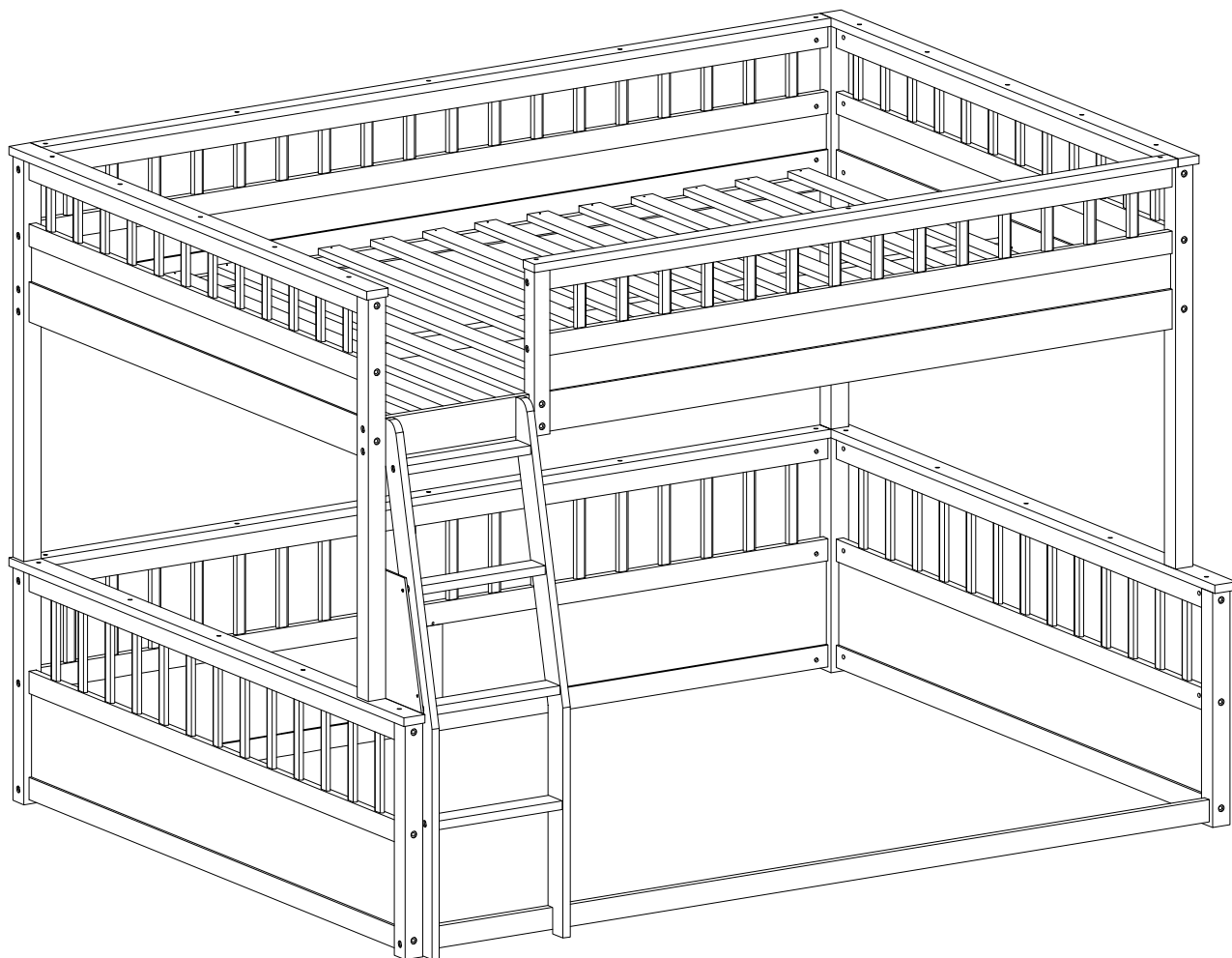



SAFETY WARNING



1. This bed is designed for use only mattress (es) meeting the following specifications on the upper bunk, and lower bunk:

Up bed





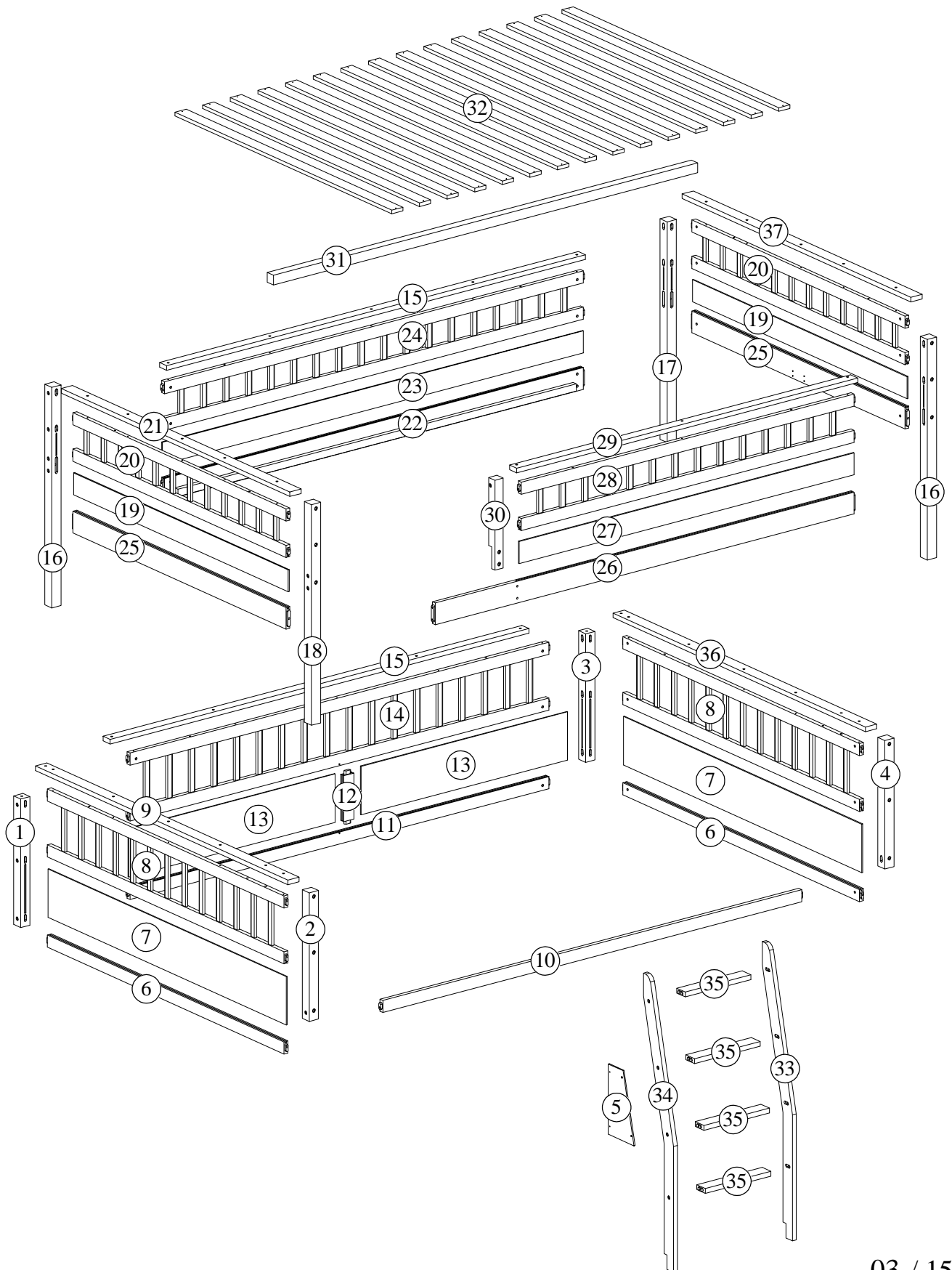

Bed type	Length	Width	Thickness
Queen Standard	80"	53 1/2 - 54"	6" max

2. Replacement parts, including additional guardrails, maybe obtained from any of our BUYER: Shenzhen Yuefeng Zhiqi Technology Co., Ltd.
A708-E1, 7th Floor, Block A, Building A, Jiangsu Building, No. 6013 Yitian Road, Fuxin Community, Lianhua Street, Futian District, Shenzhen
3. Follow the information on the warnings appearing on the upper bunk bed end structure and on the carton. Do not remove warning label from bed.
4. Always use the recommended size mattresses or mattress supports, or both, to help prevent the likelihood of entrapment or falls.
5. Surface of mattress must be at least 5" (127mm) below the upper edge of guardrails.
6. Do not allow children under 6 years of age to use the upper bunk.
7. Periodically check and ensure that the guardrail, ladder, and other components are in their proper position, free from damage, and that all connectors are tight.
8. Do not allow horseplay on or under the bed and prohibit jumping on the bed.
9. Always use the ladder for entering and leaving the upper bunk.
10. Do not use substitute part. Contact the manufacture or dealer for replacement part.
11. Use of a night light may provide added safety precaution for a child using the upper bunk.
12. Always use guardrails on both long sides of the upper bunk. If the bunk bed will be placed next to the wall, the guardrail that runs the full length of the bed should be placed against the wall to prevent entrapment between the bed and wall.
13. The use of water or sleep flotation mattresses is prohibited.
14. STRANGULATION HAZARD - Never attach or hang items to any part of the bunk bed that are not designed for use with the bed; for example, but not limited to, hook, belts and jump ropes.
15. Keep these instruction for future reference.
16. Prohibit more than one person on upper bunk
17. We recommend assembling your bunk bed on the shipping carton to protect your floor or carpet.
18. Be certain all staples are out of the box before beginning assembly on the shipping carton.



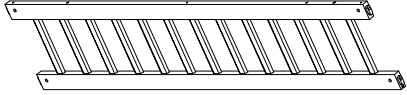
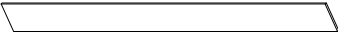

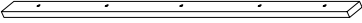
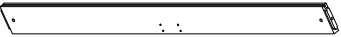
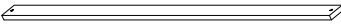

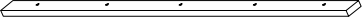

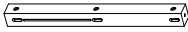
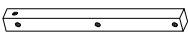
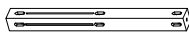
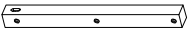
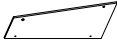
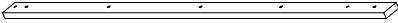

ASSEMBLY INSTRUCTION

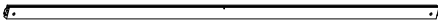

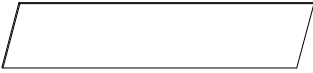
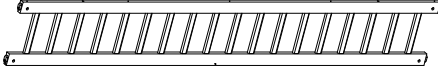

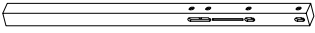
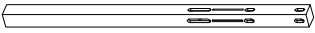
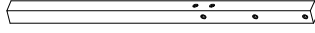
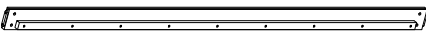
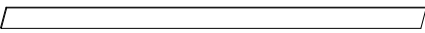
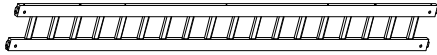
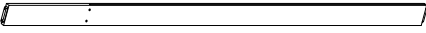
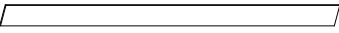
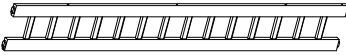

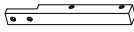
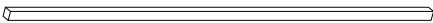

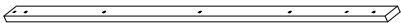



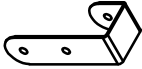

Part List : SKU : BW00146

<p>6</p>  <p>Lower Hip Bar-2pcs</p>	<p>7</p>  <p>Lower Side Board-2pcs</p>	<p>8</p>  <p>Lower Hip Frame-2pcs</p>
<p>19</p>  <p>Upper side board-2pcs</p>	<p>20</p>  <p>Upper hip frame-2pcs</p>	<p>21</p>  <p>Left side frame cover-1pc</p>
<p>25</p>  <p>Lower hip bar-2pcs</p>	<p>32</p>  <p>Slat-15pcs</p>	<p>35</p>  <p>Steps-4pcs</p>
<p>37</p>  <p>Upper side frame cover-1pc</p>		

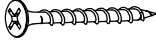
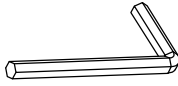
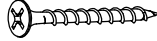
Part List : SKU : BW00146

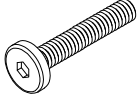
1		2		3	
	Left Hind Leg(Floor 1)-1pc		Left Front Leg(Floor 1)-1pc		Right Hind Leg(Floor 1)-1pc
4		5		9	
	Right Front Leg(Floor 1)-1pc		Stair Planks-1pc		Left Headboard(Floor 1)-1pc
10		11		12	
	Front and Bottom Crossbar-1pc		Lower Back Cross Bar-1pc		Frame Standing Puzzle-1pc
13		14		15	
	Back Frame-2pcs		Rear Frame-1pc		Rear frame railing cover-2pcs
16		17		18	
	Left front right hind leg(Foor 2)-2pcs		Right Hind Leg(Foor 2)-1pc		Left Front Leg(Foor 2)-1pc
22		23		24	
	Back bed shoulder-1pc		Rear Railing-1pc		Rear frame-1pc
26		27		28	
	Front Bed Shoulder-1pc		Front railing-1pc		Front railing frame-1pc
29		30		31	
	Front railing-1pc		Railing Puzzle-1pc		Bed rail support-1pc
33		34		36	
	Right foot of the ladder-1pc		Left foot of the ladder-1pc		Lower side frame cover-1pc

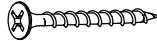

Hardware List : SKU : BW00146

<p>A</p>  <p>Ø8 x 30 mm Wood dowel-14pcs</p>	<p>B</p>  <p>Ø1/4" x 80 mm Hex-Head bolts-48pcs</p>	<p>C</p>  <p>Ø1/4" x 60 mm Hex-Head bolts-8pcs</p>
<p>D</p>  <p>Ø1/4" x 12 mm Horizontal-Hole bolts-56pcs</p>	<p>E</p>  <p>U bracket-2pcs</p>	<p>F</p>  <p>Ø1/4" x 16 mm T-nut-2pcs</p>
<p>G</p>  <p>M4 x 35 mm Wood Screws-35pcs</p>	<p>H</p>  <p>Allen Key-1pc</p>	<p>J</p>  <p>M4 x 15 mm Wood Screws-20pcs</p>
<p>K</p>  <p>Metal bracket-2pcs</p>	<p>L</p>  <p>Ø1/4" x 30 mm Hex-Head bolts-1pc</p>	<p>M</p>  <p>Ø1/4" x 50 mm Hex-Head bolts-1pc</p>
<p>N</p>  <p>Ø10 x 90 mm Round iron bar-4pcs</p>	<p>O</p>  <p>Angle Metal-2pcs</p>	<p>P</p>  <p>M4 x 30 mm Wood Screws-34pcs</p>

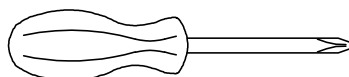
ASSEMBLY TOOLS REQUIRED (NOT INCLUDED)



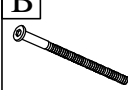

STEP1:

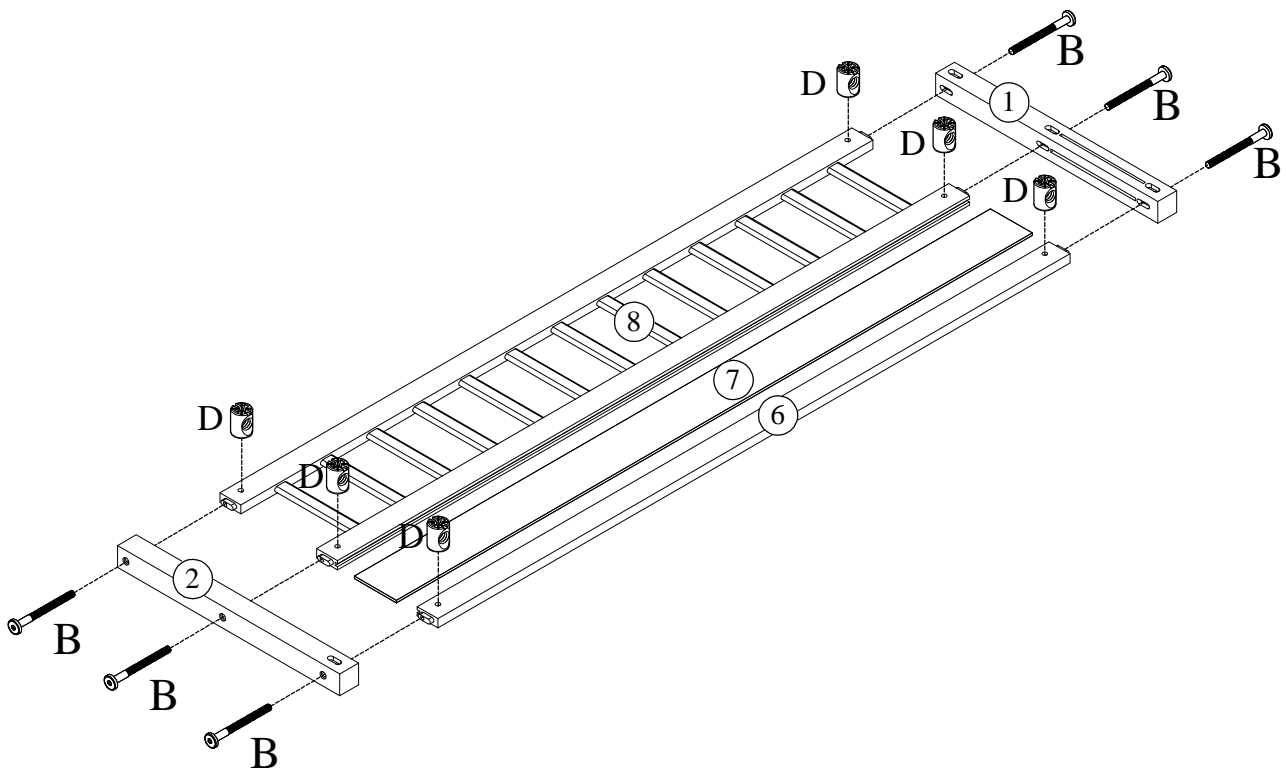
B 	D 
6PCS	6PCS

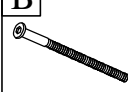

STEP2:

B 	D 
6PCS	6PCS

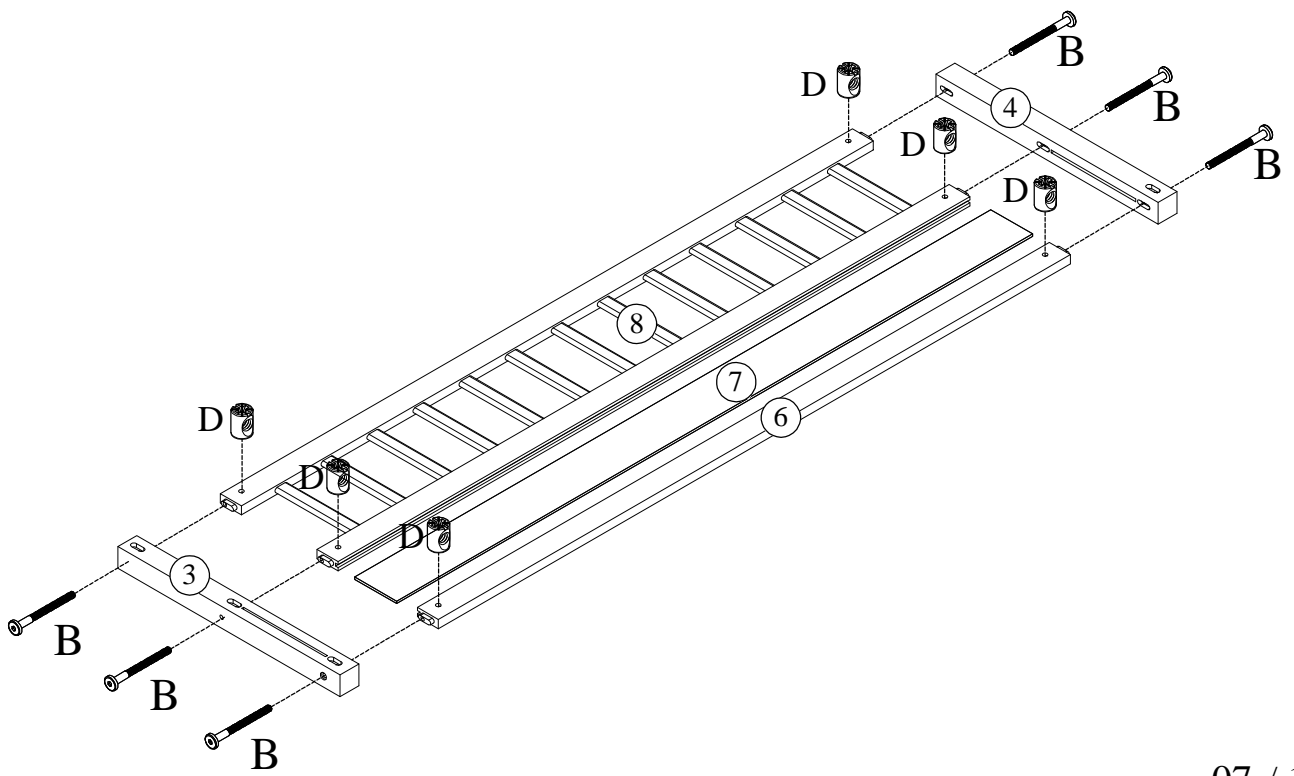

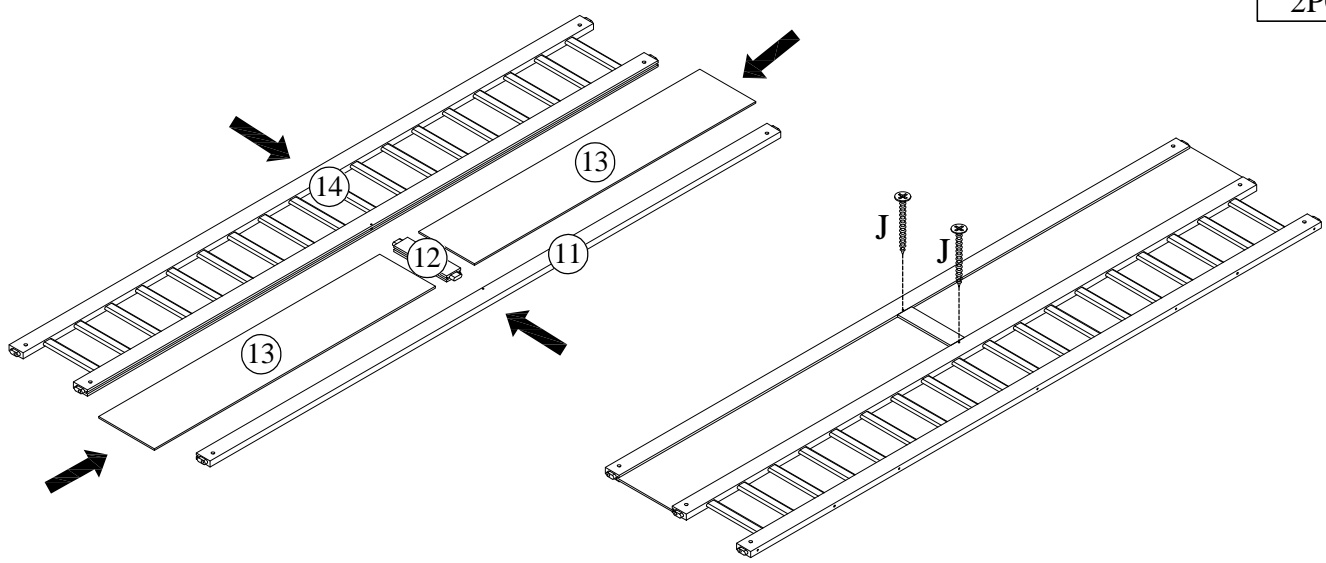

STEP3:

J

2PCS

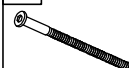

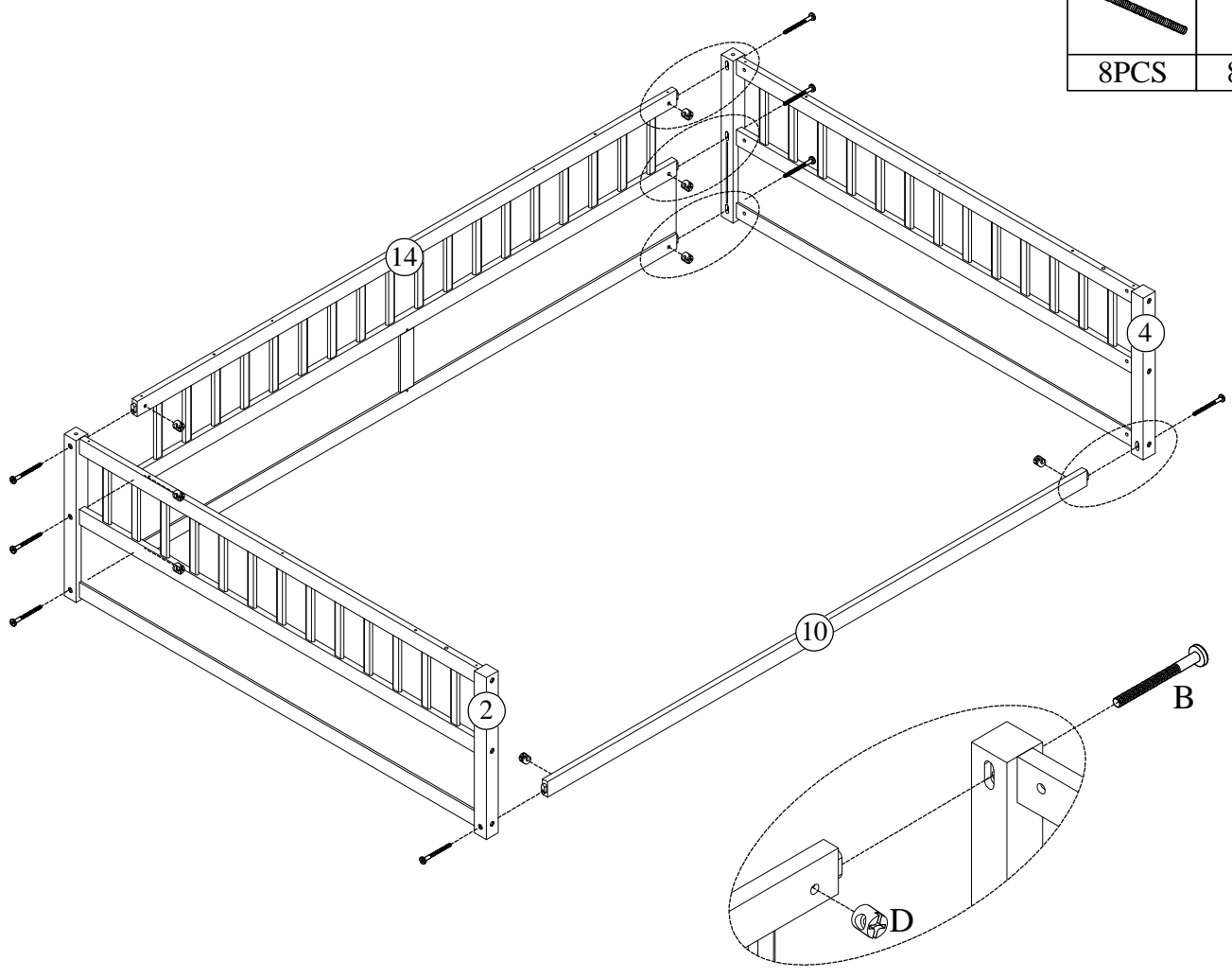

STEP4:

B	D
	
8PCS	8PCS





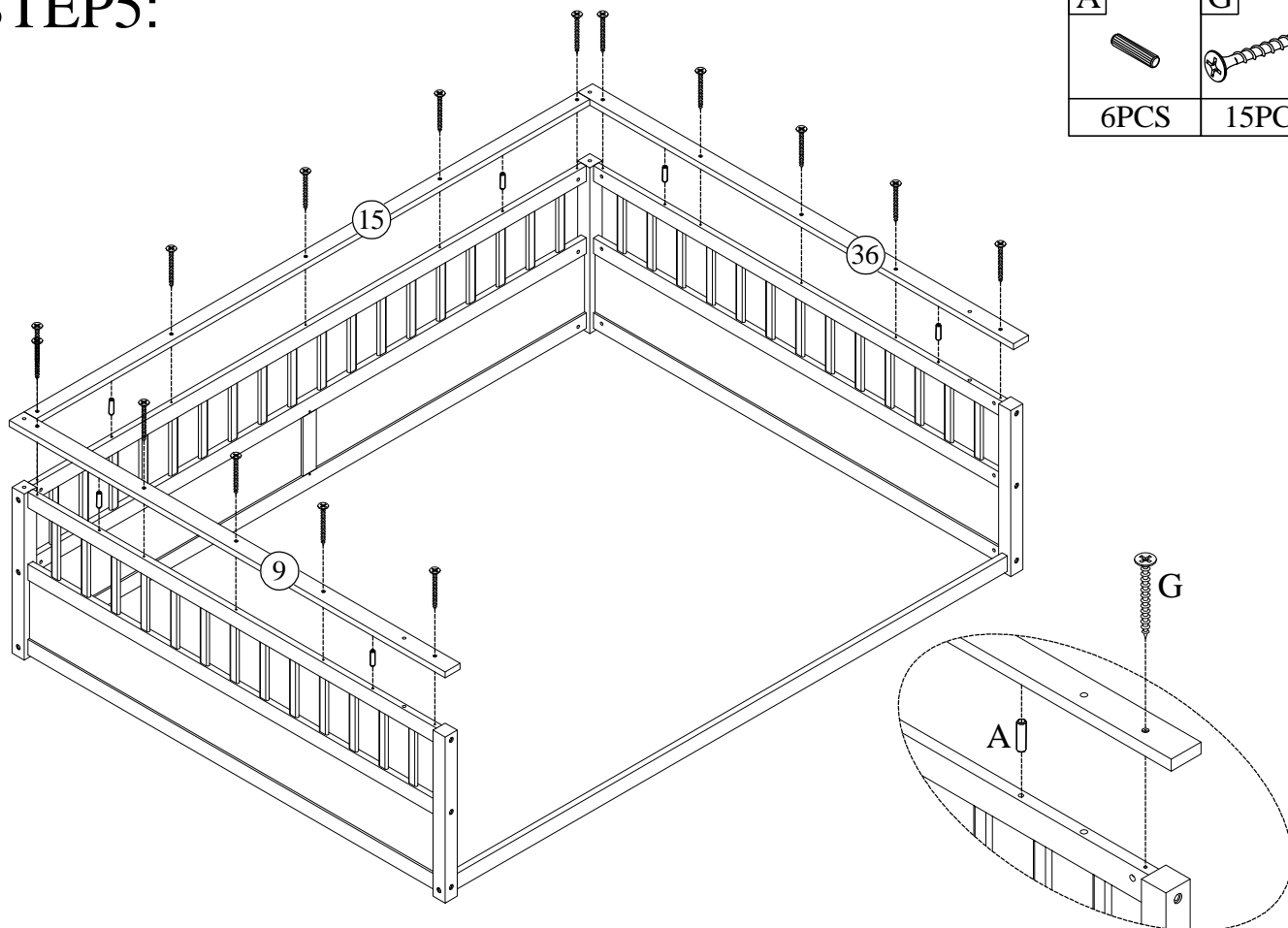

STEP5:

A 	G 
6PCS	15PCS



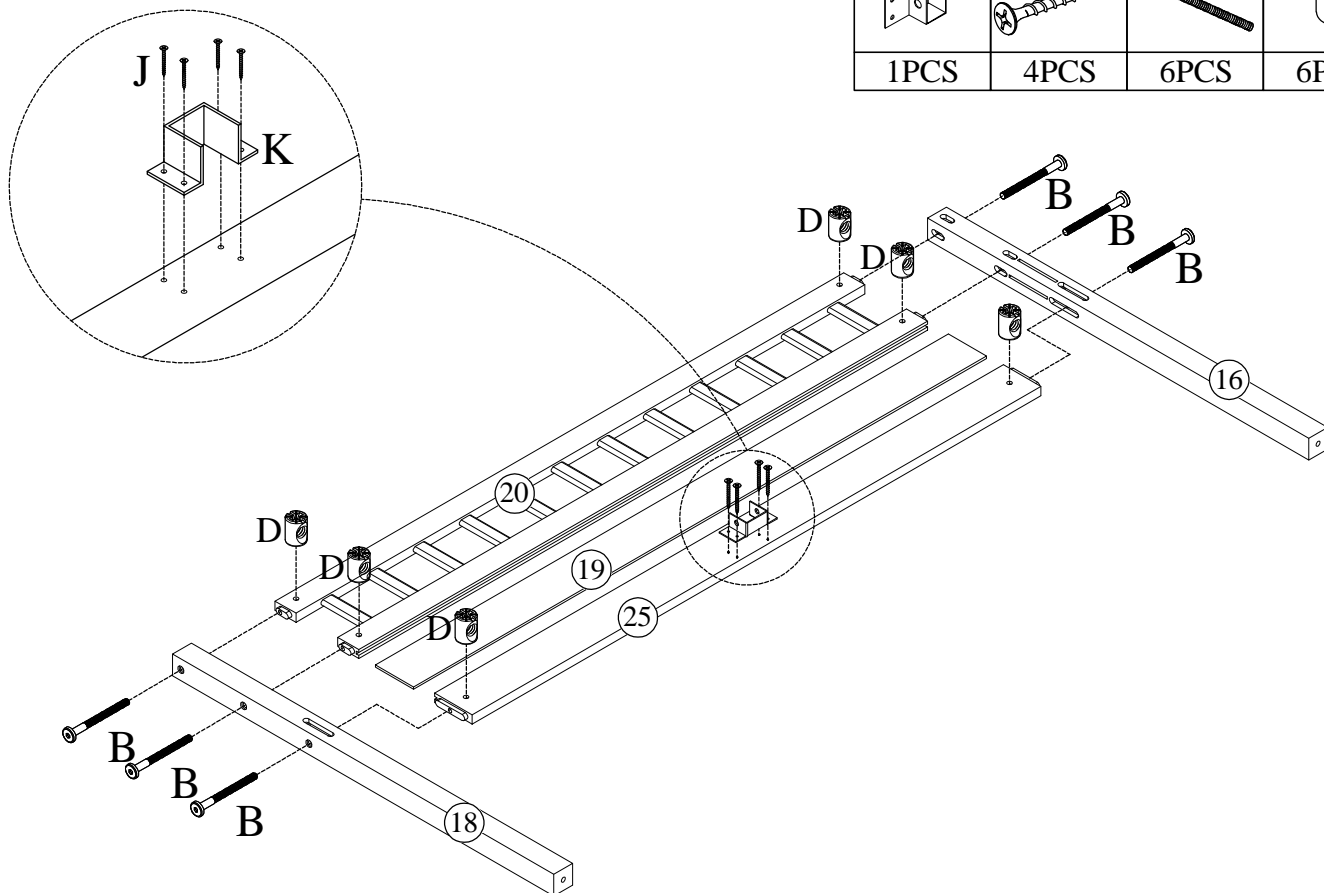

STEP6:

K 	J 	B 	D 
1PCS	4PCS	6PCS	6PCS



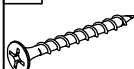
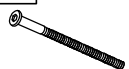

STEP7:

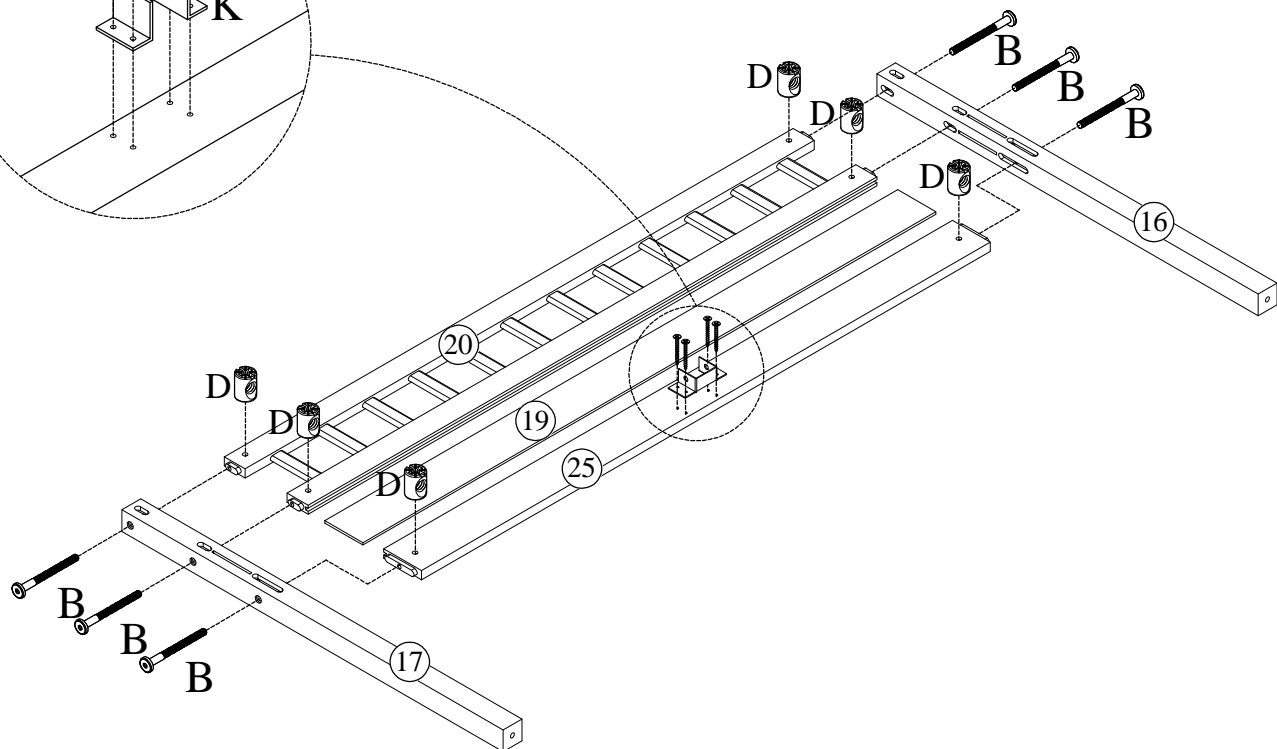
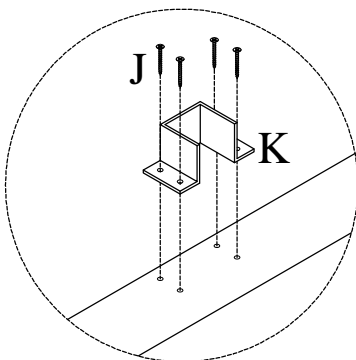
K 	J 	B 	D 
1PCS	4PCS	6PCS	6PCS



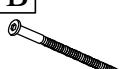

STEP8:

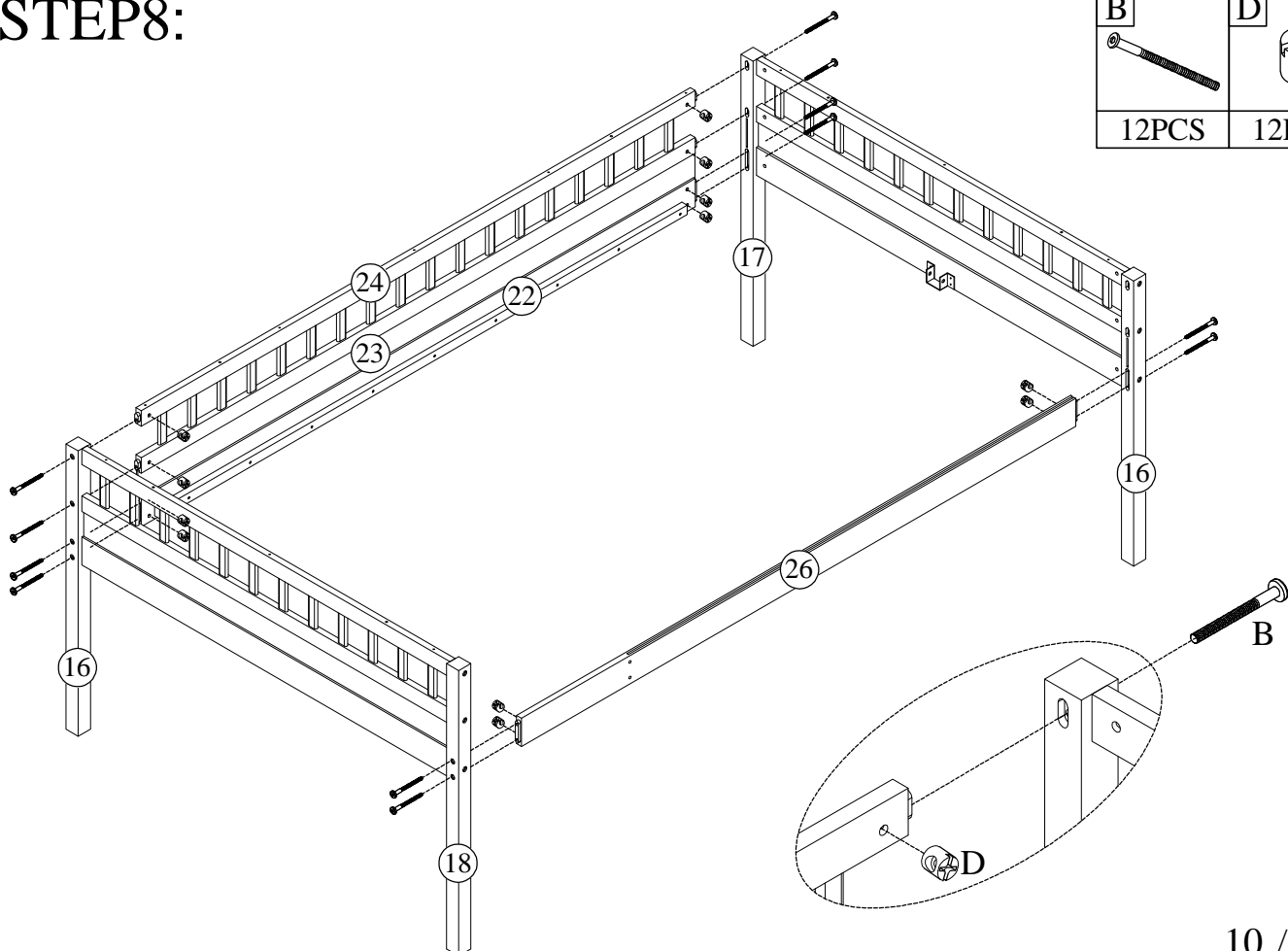
B 	D 
12PCS	12PCS



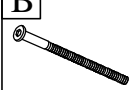

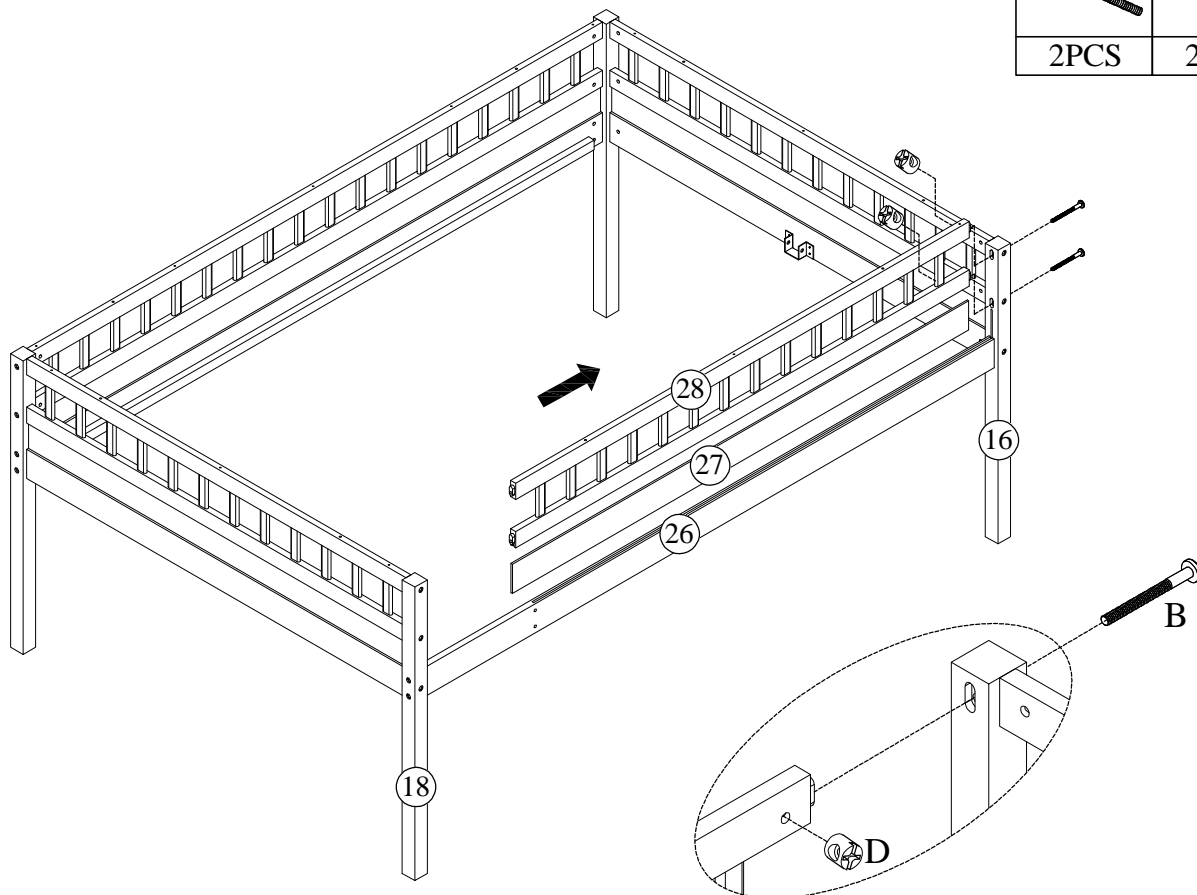

STEP9:

B 	D 
2PCS	2PCS

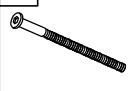

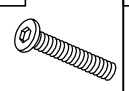

STEP10:

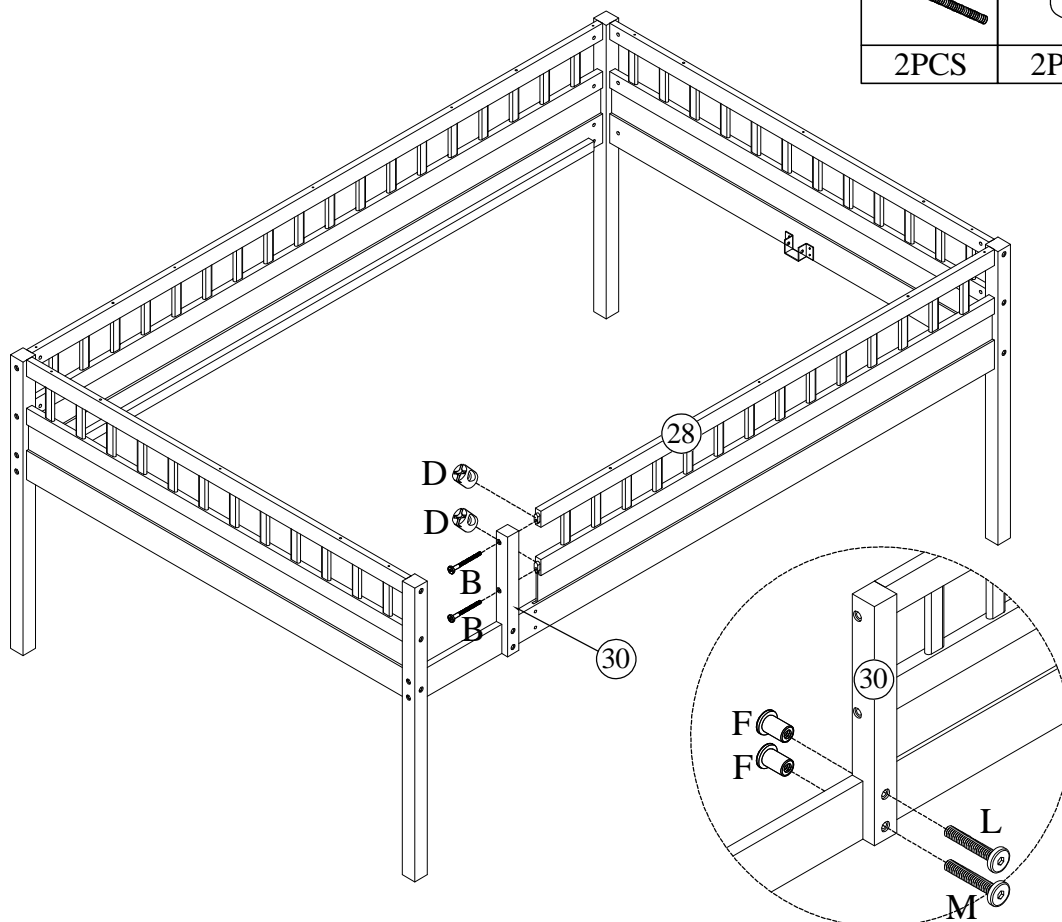
B 	D 	M 	F 
2PCS	2PCS	1PC	2PCS
			L 
			1PC



STEP 11:

A	G
	
8PCS	20PCS

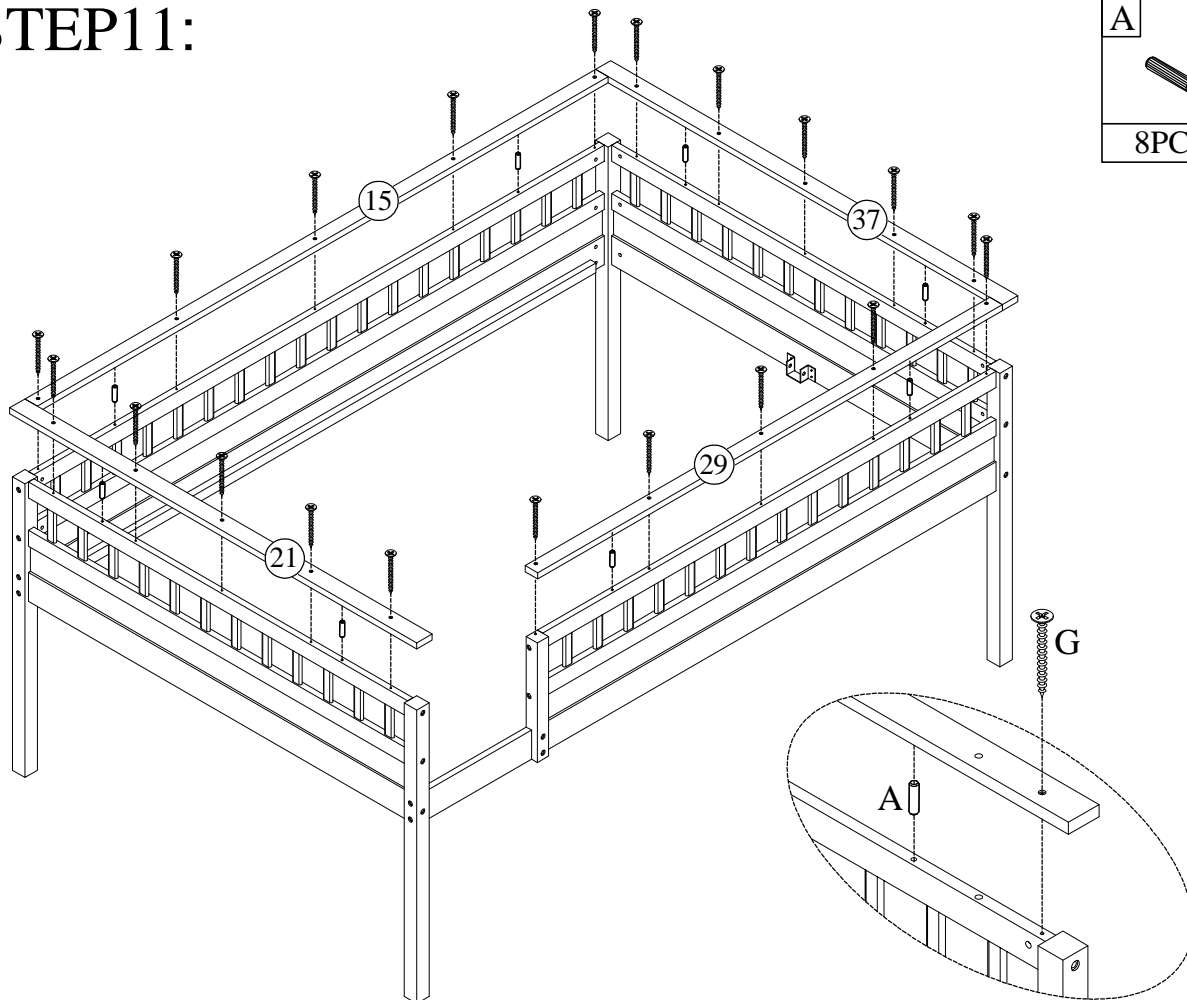

STEP 12:

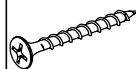
P

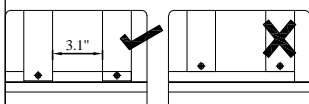
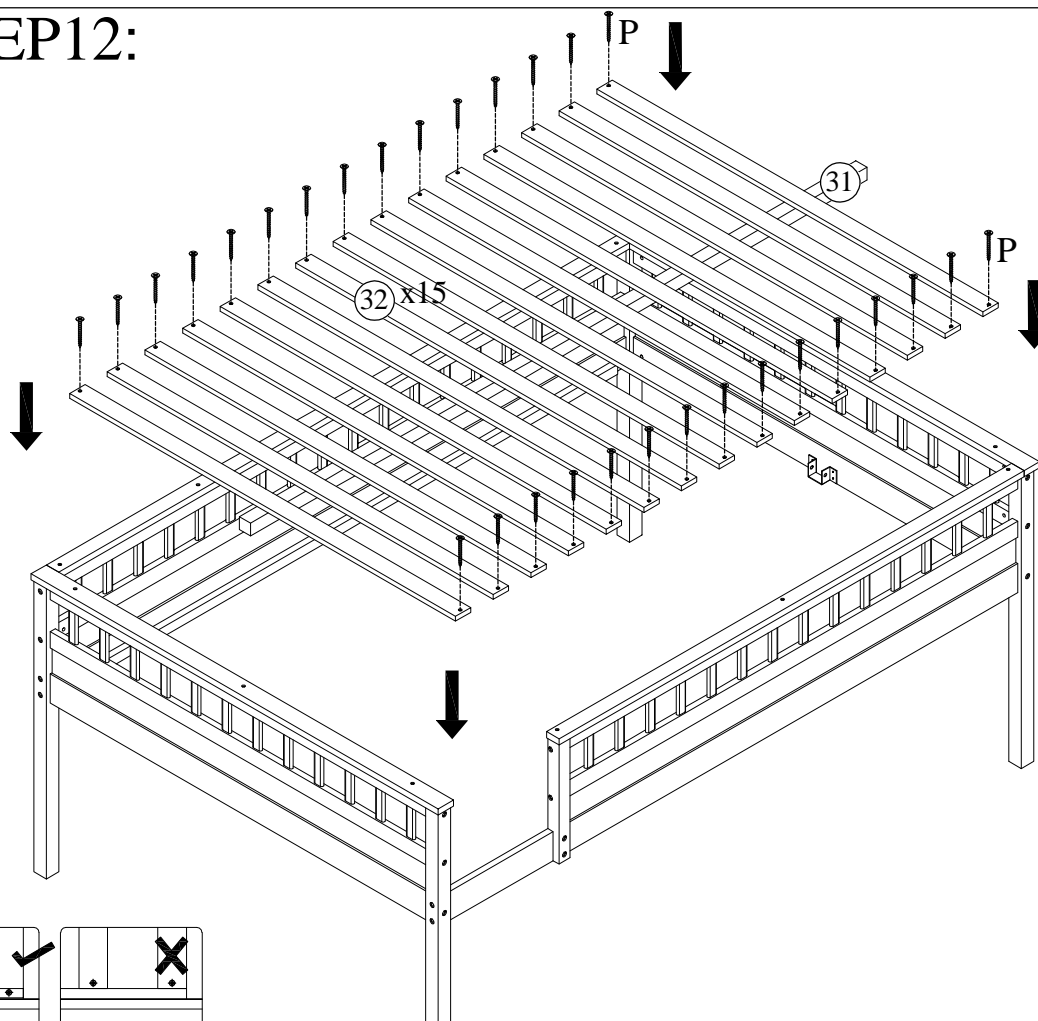
30PCS



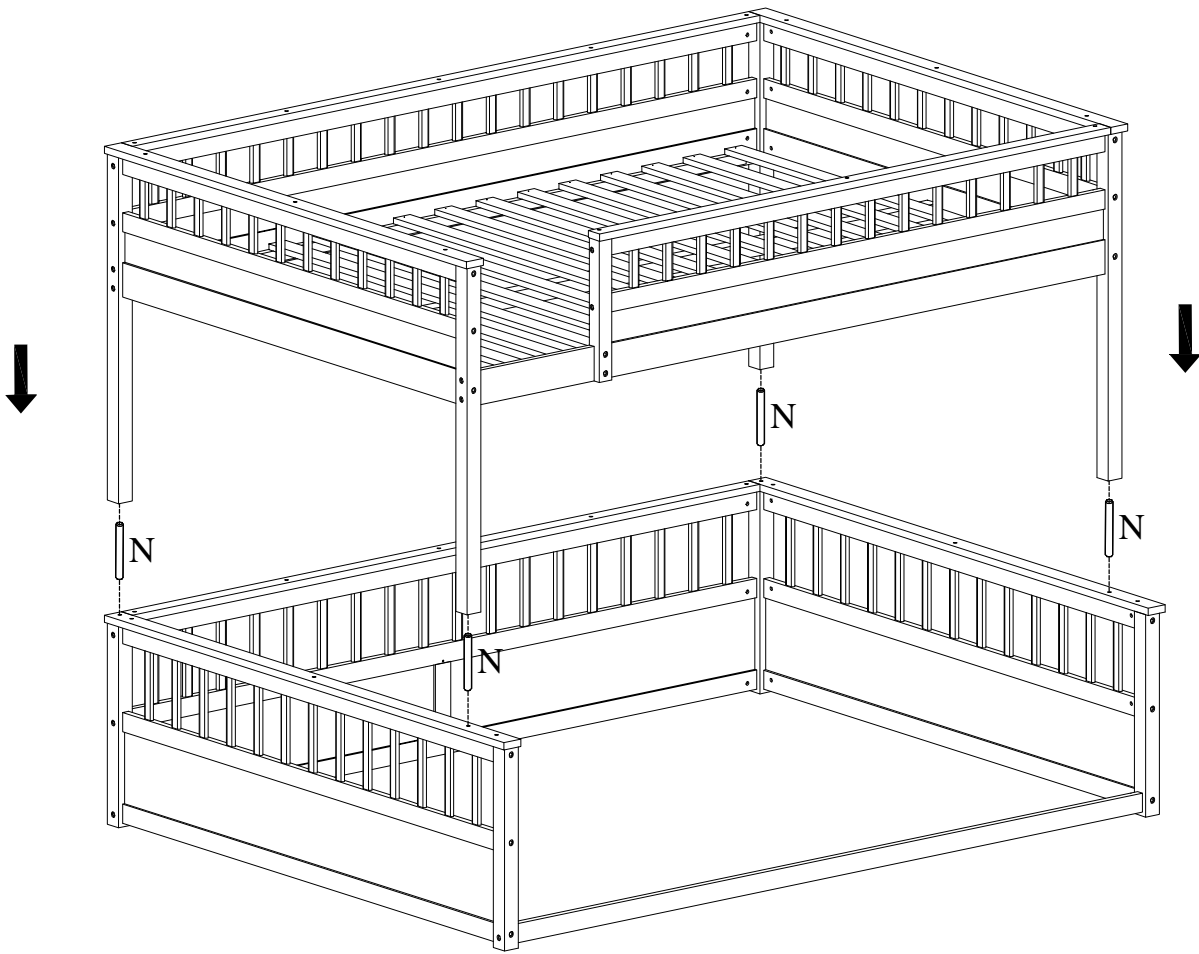

STEP13:

N	
4PCS	



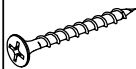
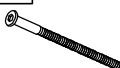

STEP14:

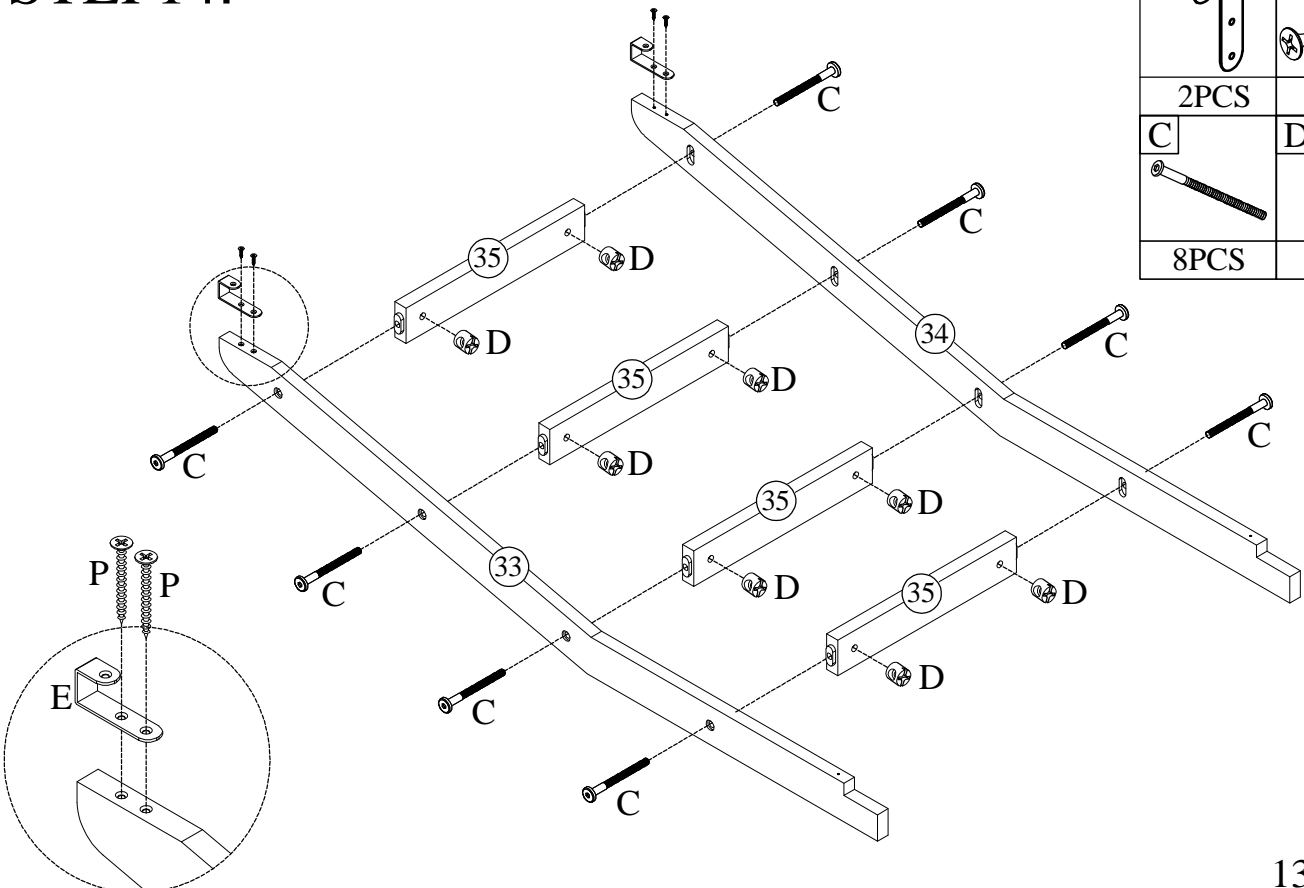
E		P	
2PCS		4PCS	
C		D	
8PCS		8PCS	



STEP15:

J	O
	
6PCS	2PCS

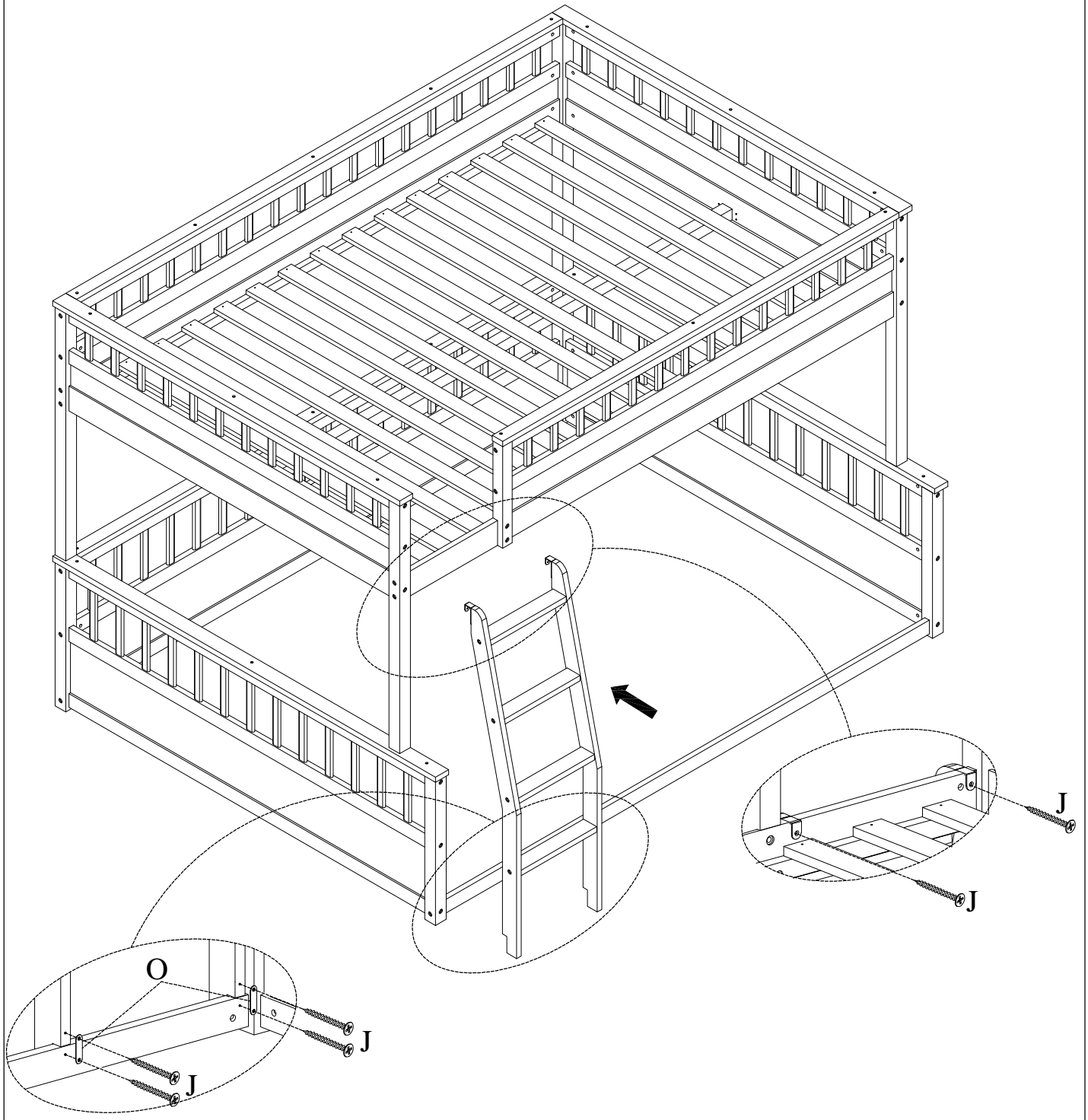

STEP16:

J

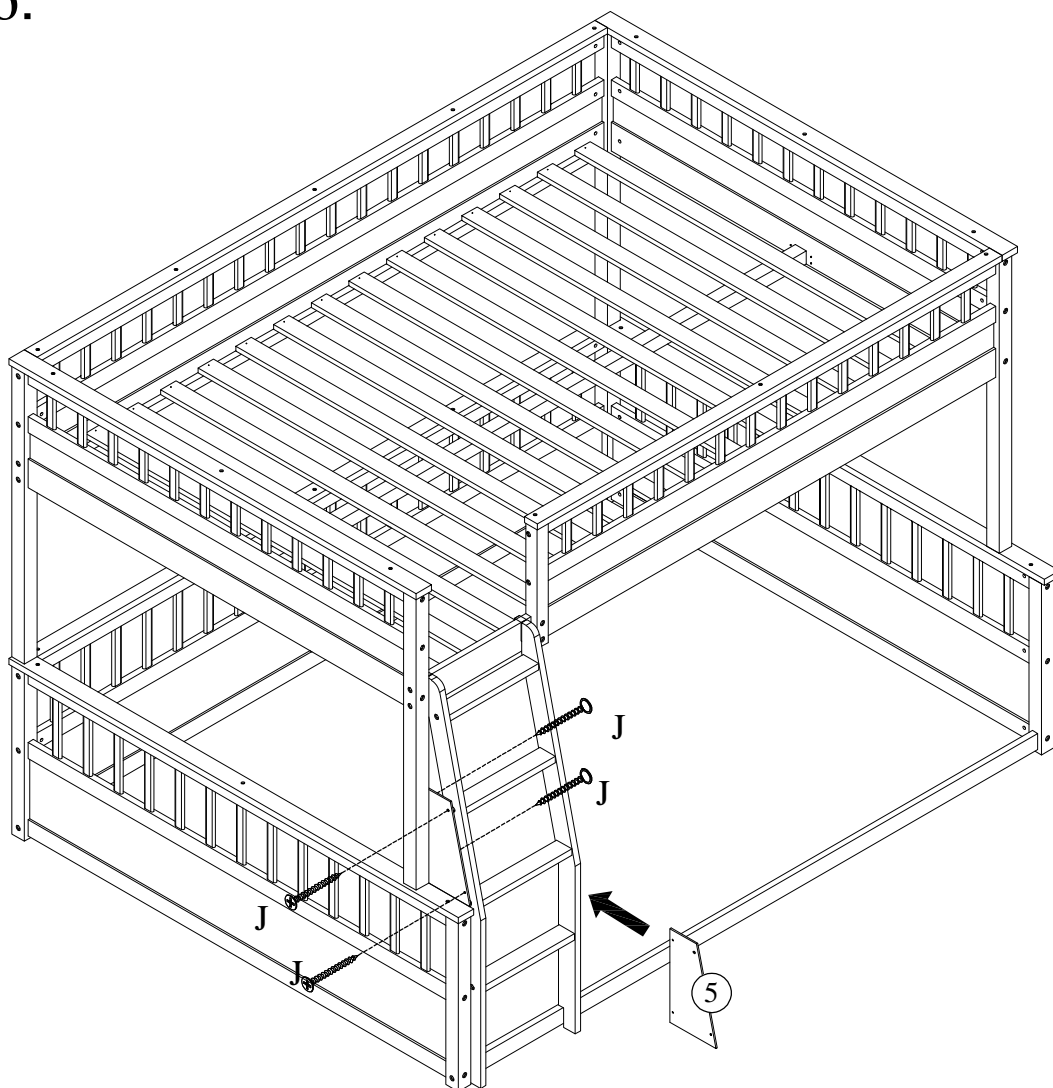
4PCS



COMPLETED

