











Assembly Instructions

Caution : You must read this before you proceed

Care & Maintenance

- ⊘  ● Not for commercial use. For residential use only.
- ✓  ● Furniture may scratch floors. We recommend using furniture pads to protect your floors.
- ⊘  ● Do not put hot items directly on furniture surface.
- ⊘  ● Do not clean furniture with harsh cleansers or polish.
- ⊘  ● Do not place furniture under direct sunlight.
- ⊘  ● Do not place furniture near heating or cooling vents.
- ⊘  ● Do not write on furniture without a padded barrier to protect the surface.
- ⊘  ● Do not place furniture outside . For indoor use only.
- ⊘  ● Stains may be removed with mild soap solution and damp cloth.
- ⊘  ● Children should not climb or jump on the furniture.
- ✓  ● Dust and pick-up spills using a clean, non-colored, lint-free cloth.

Please look in Seat frame for hardware packs and legs.

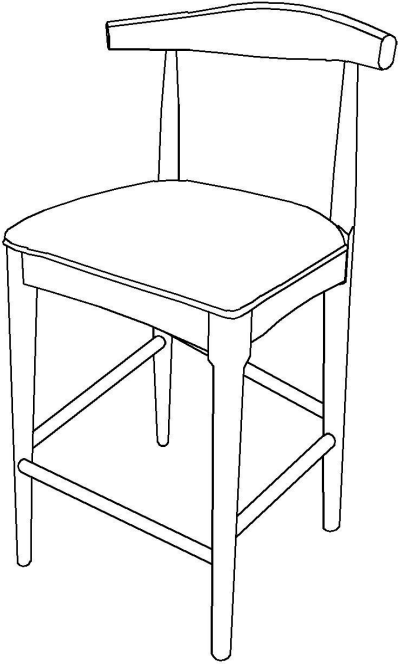

Sets often ship in multiple boxes and may arrive a day or two apart.

Counter Stool



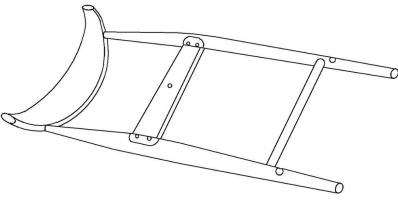
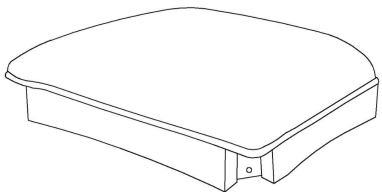
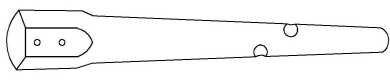

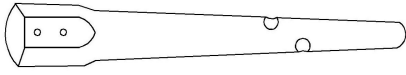





Parts List

Label	Picture	Description	QTY
A		Back with leg	1
B		Seat	1
C		Leg	1

D		Leg	1
E		Link	3

Hardware

Label	Picture	Description	QTY
①		Allen Wrench (M8)	1
②		Bolt (M8x45mm)	2
③		Bolt (M8x57mm)	5
④		Bolt (M8x83mm)	5
⑤		Spring Washer (M8)	12
⑥		Flat Washer (M8)	12
⑦		Screw (Φ8x38mm)	7
⑧		Screwdriver (not provided)	1

Assembly Preparation

Before Beginning Assembly:

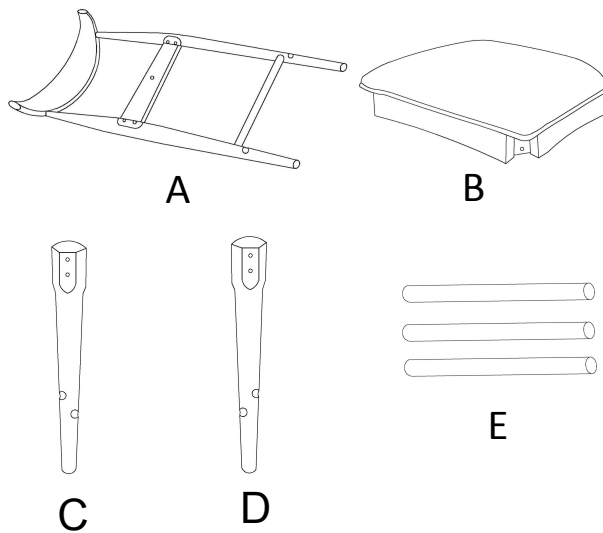

- ① L-shaped bolt
- ② Bolt x2
- ③ Bolt x5
- ④ Bolt x5
- ⑤ Washer x12
- ⑥ Washer x12
- ⑦ Screw x7



• Read instructions, cover to cover-



• Have 2 adults on hand for assembly-



• Do not assemble on flooring or carpet-



• Assemble on a clean non-marring surface (packing foam)-



• Save all packaging until finished-

Assembly Steps

Overview

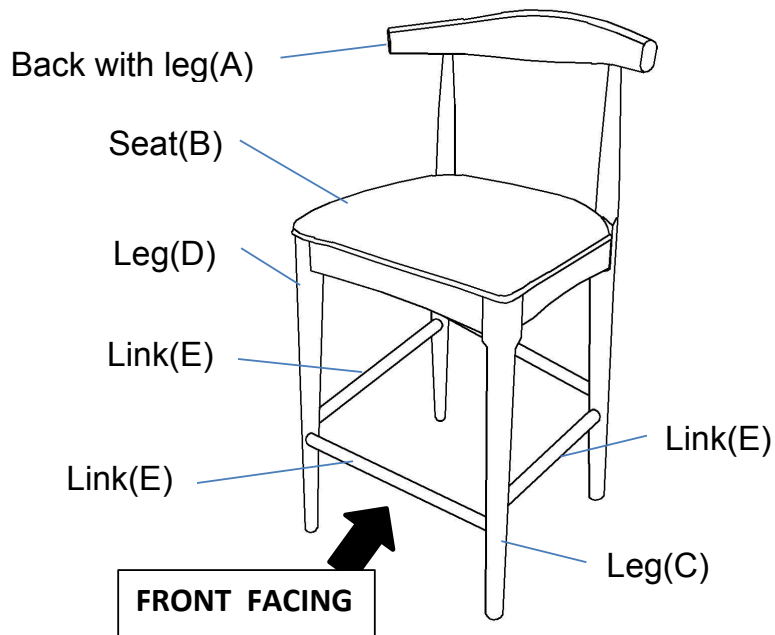

This Counter Stool has multiple parts and may require up to some 30 minutes to assemble. To give you an overview of the Counter Stool parts, the above picture is to help you put the various parts into perspective. Please read through the instructions below to familiarise yourself with the parts and steps before assembly.

Step 1

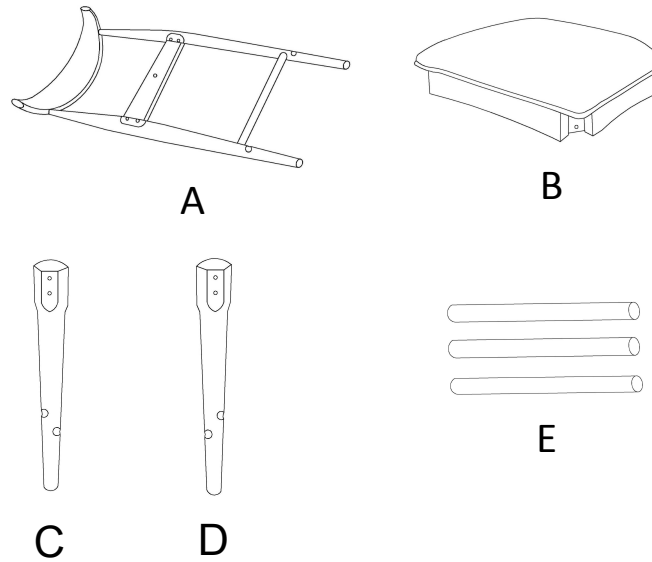

Place all Parts on a clean and flat surface.

Step 2

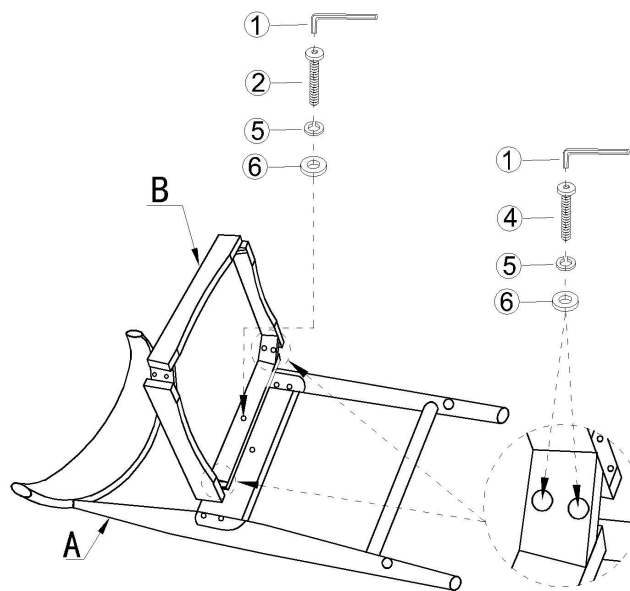

Use the Allen Wrench (①), Bolts (②), (④), Spring Washers (⑤) and Flat Washers (⑥) to install the Seat (B) as shown in the figure above. **Do not fully tighten the Bolts at this time.**

Step 3

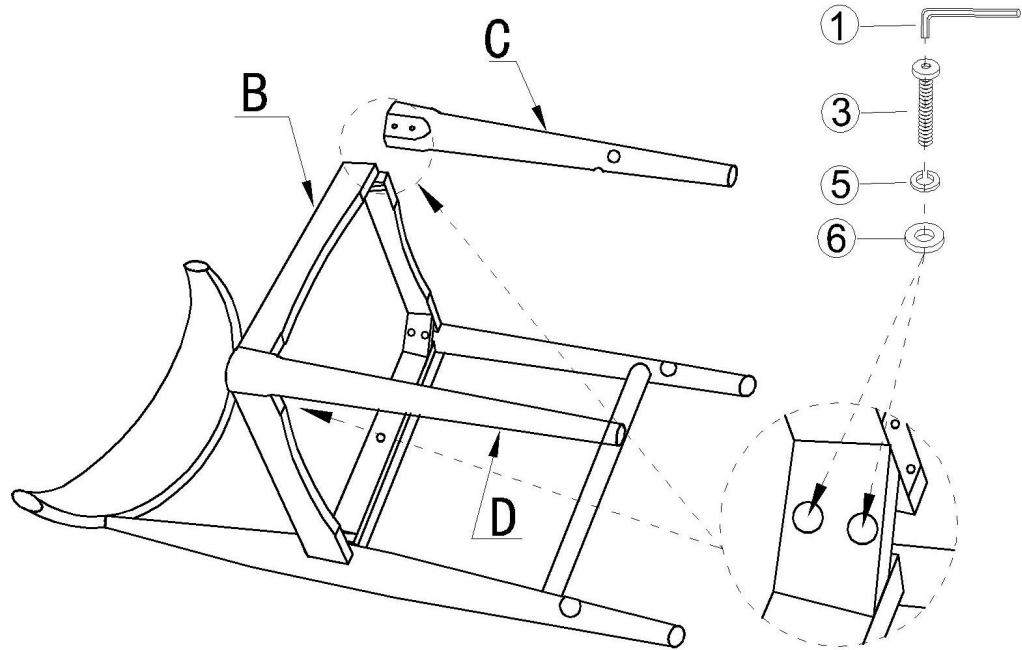

Use the Allen Wrench (①), Bolts (③), Spring Washers (⑤) and Flat Washers (⑥) to install the Legs (C) (D) as shown in the figure above. **Do not fully tighten the Bolts at this time.**

Step 4

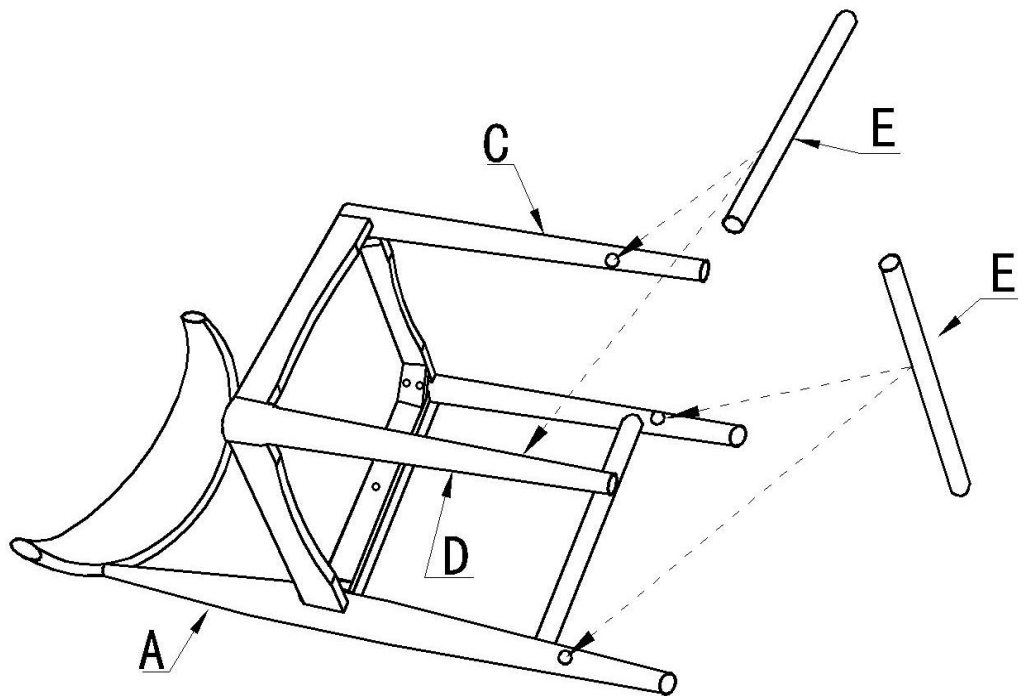

Place the Link (E) in the Back with leg (A) and connect the leg (C) (D). **Do not fully tighten the Bolts at this time.**

Step 5

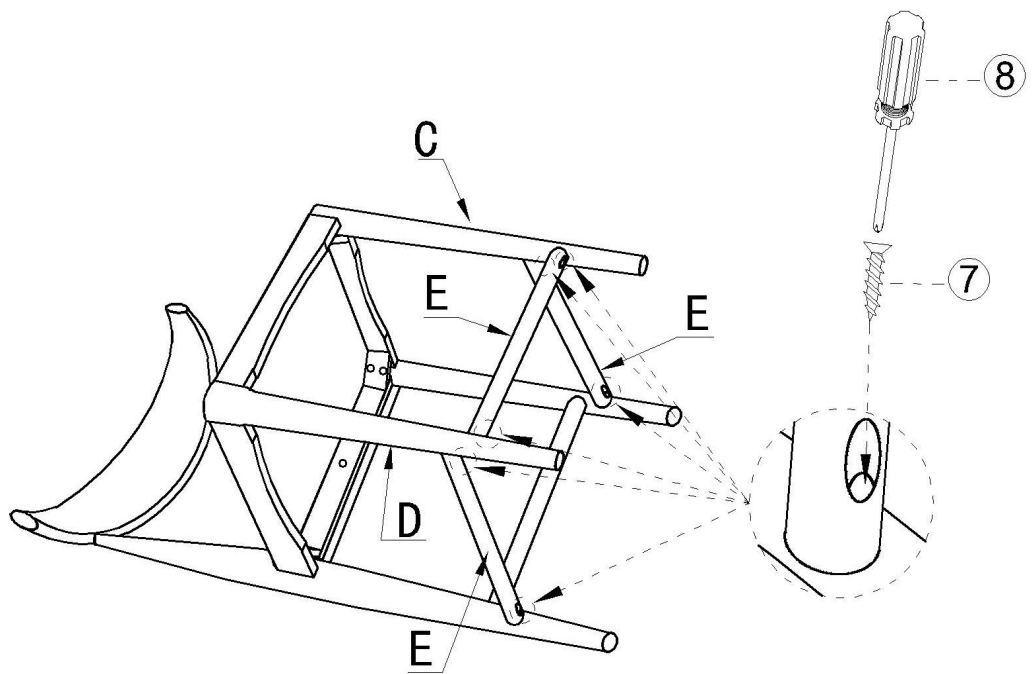

As shown in the figure: Use Screwdriver (⑧) and Screw (⑦) to fix the Link (E) to the Back with leg (A) and leg (C) (D) .

Step 6

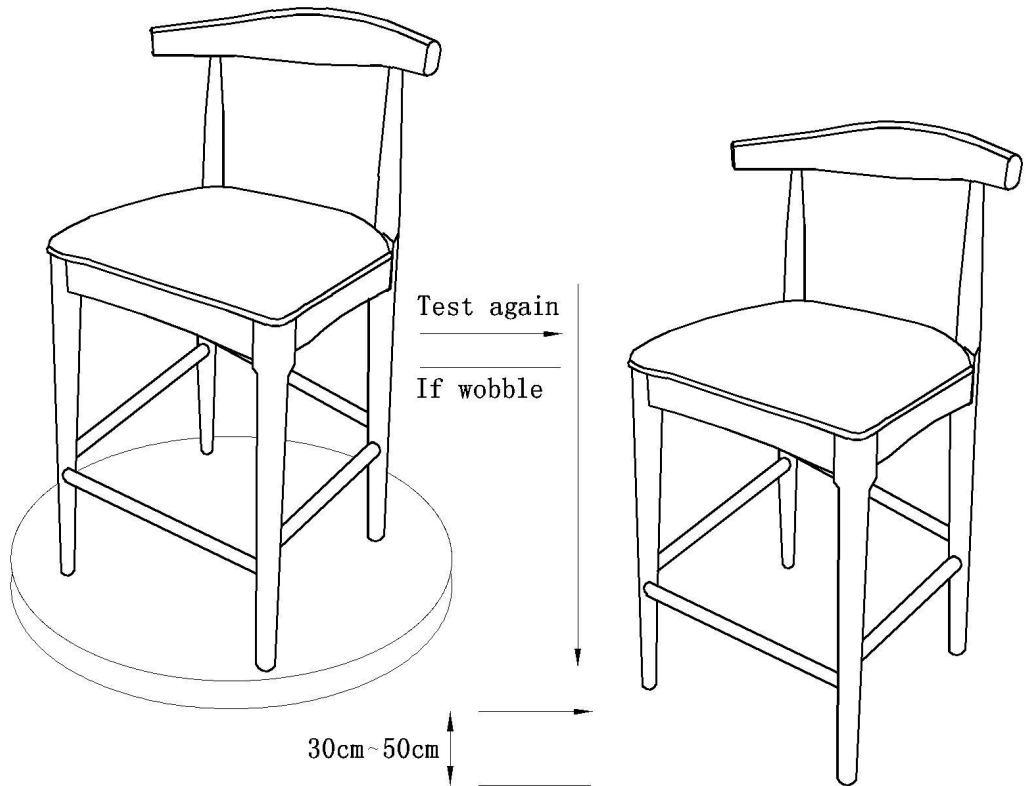

Place the Counter Stool on a level Surface to check for wobbles.
If it wobbles, lift the Counter Stool some 30cm to 50cm high from the ground.
Keep your feet and toes well away from the drop zone.
Drop the Counter Stool freely and vertically, with all four legs hitting the ground at the same time.
This Drop Test will help to ensure that all Bolts and gaps reach full alignment status.
Test again for evenness on a Level Surface.
If no wobbles are found, proceed to tighten all the Bolts.
When tightening the Bolts, tighten sequentially.
Do not fully tighten any Bolt fully and then move on towards the next one.
This may cause the frame to warp.
If there are still wobbles, loosen the Bolts and execute this same drop test.

Step 7

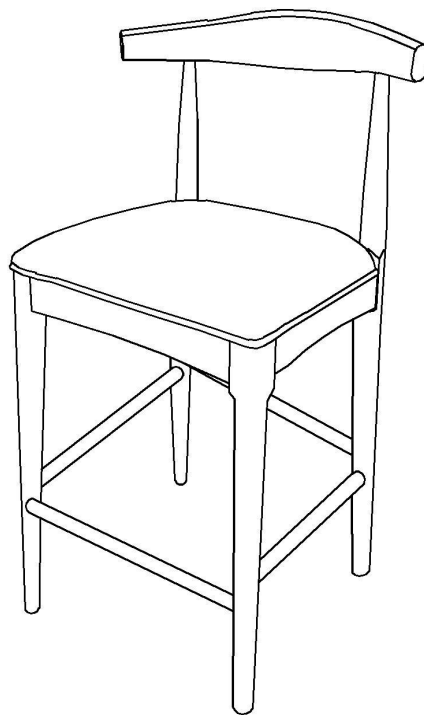

Your Counter Stool is ready for use.
This Counter Stool can only be used on a flat, level surface.