

D- Montageanleitung

GB- Assembly instructions

F- Instructions de montage

PL- Instrukcja montażu

RU- Инструкция по монтажу

NL- Montagehandleiding

TR- Montaj talimatı

RO- Instrucțiuni de montaj

IT- Istruzioni per il montaggio

SK- Návod na montáž

CZ- Návod k montáži

HU- Szerelési útmutató

BG- Ръководство за монтаж

P- Instruções de montagem

ES- Instrucciones de montaje

SRB- Uputstvo za montažu

SLO- Navodila za vgradnjo

HR- Upute za montažu

LT- Montavimo instrukcija

LV- Montāžas instrukcija

EST- Montaažijuhend

S- Monteringsanvisning

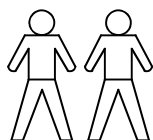

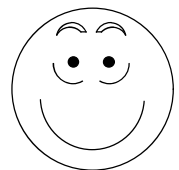
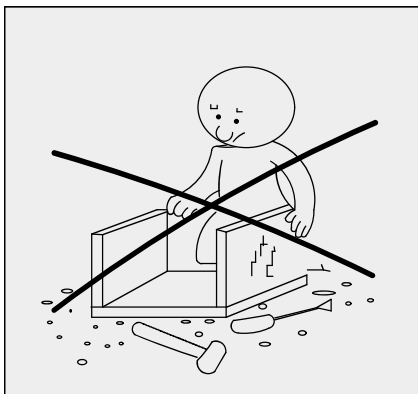
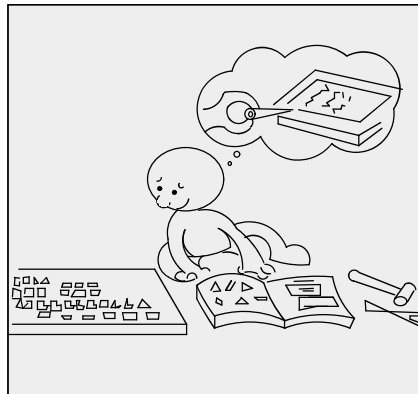
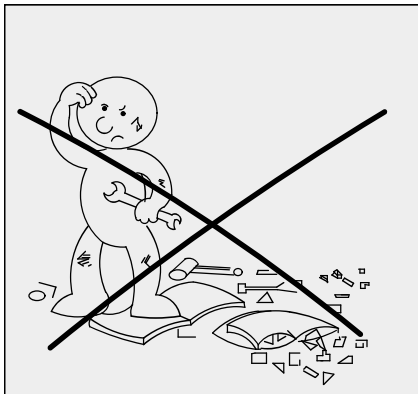
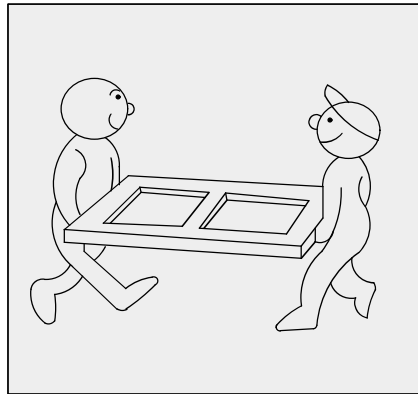
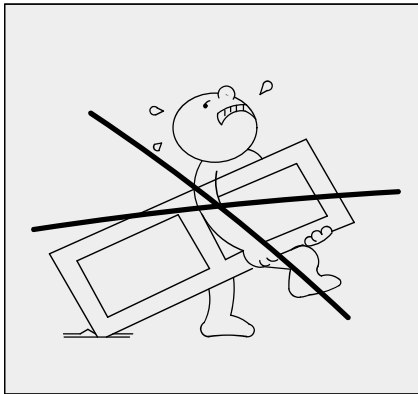
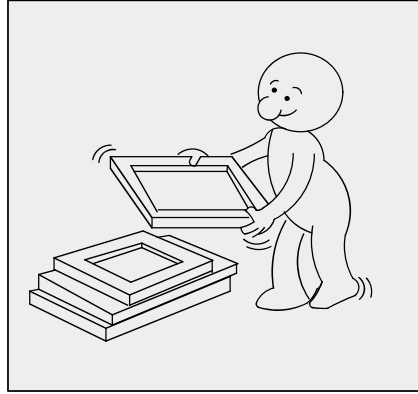
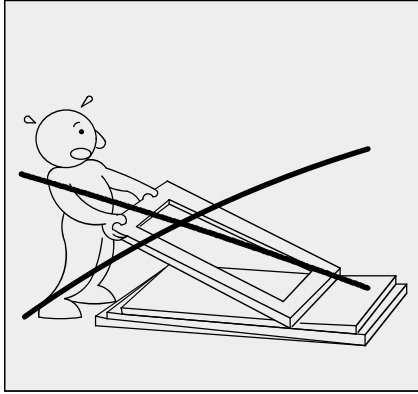
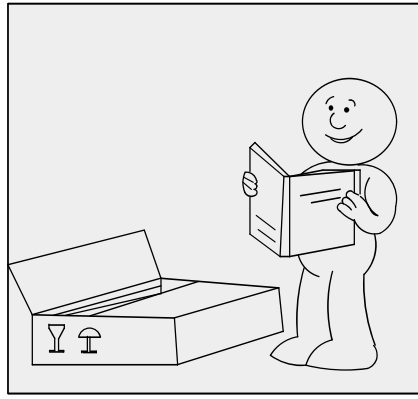
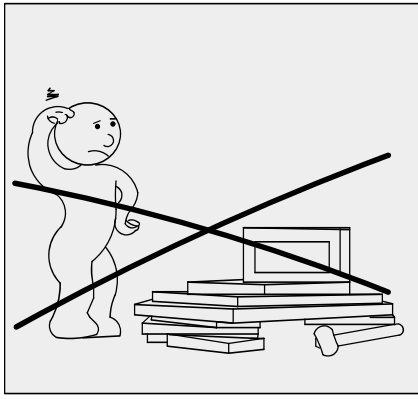





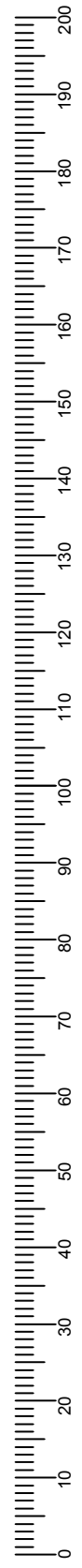
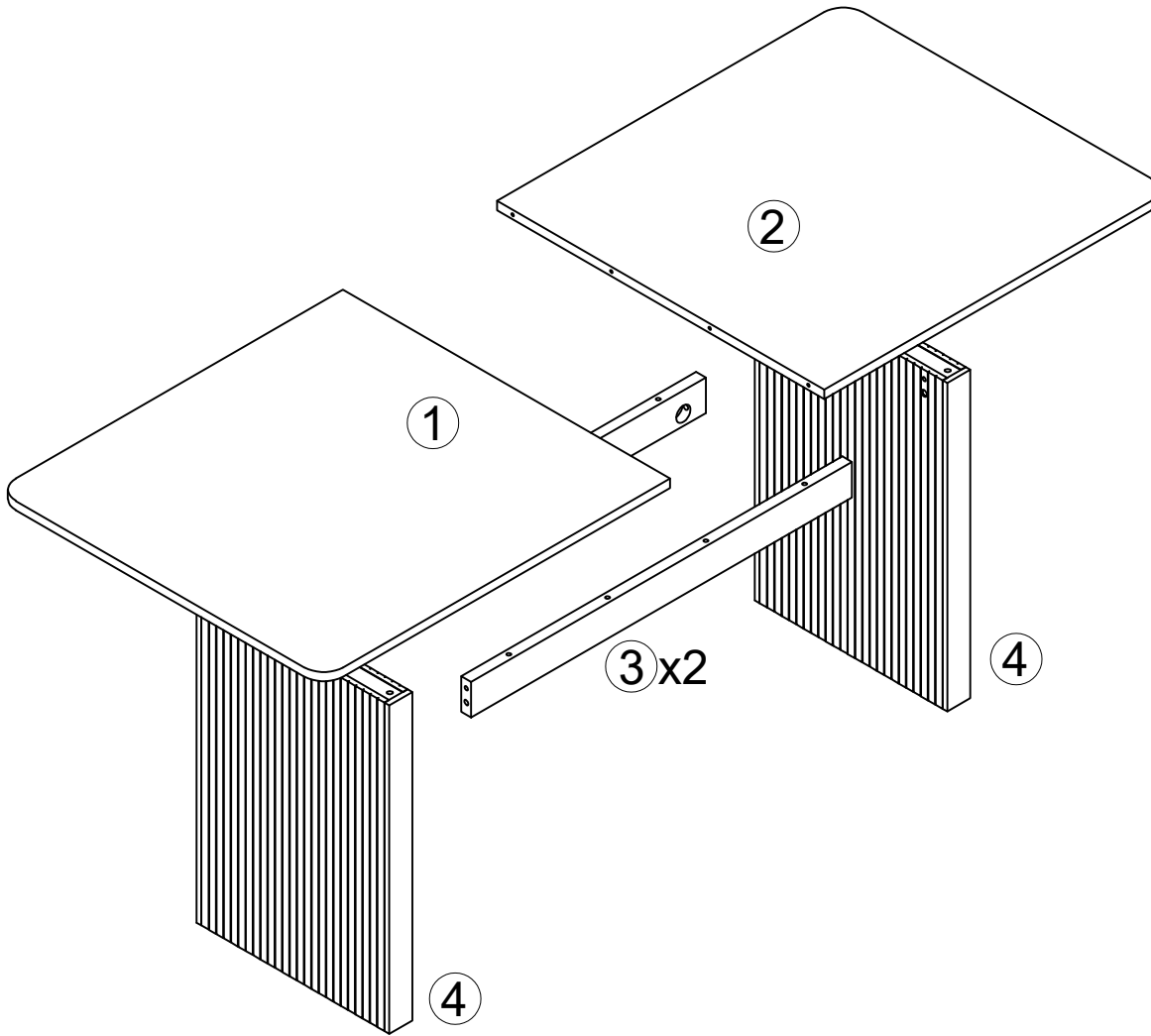



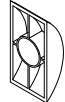



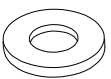

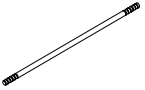

Servicekarte/ Сервизна карта/ Carte service/ Servisní karta/ Service card/ Tarjeta de servicio/
 Servisna kartica/ Teeninduskaart/ Szervizlevél/ Servis karti/ Scheda di servizio/ Techninés
 priežiūros kortelė/ Servisa karte/ Servicekaart/ Servisna kartica/ Cartão de serviços/ Karta
 serwisowa/ Carte de service/ Сервис-карта/ Servicekort/ Servisna kartica/ Servisná karta

Item name

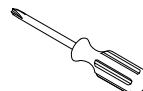

A  ø10x40 x4	B  M8x80mm x4	C  M8 x4	D  M8 x12	E  M8 x4
F  M8x20 x4	G  M10x20 x4	H  M10 x4	I  L=744mm x4	J  M8x55 x8
K  M8x19 x8	L  x2	M  ø3x16mm x8	N  M8 x1	O  x1
P  5mm x1	Q  x4			

1

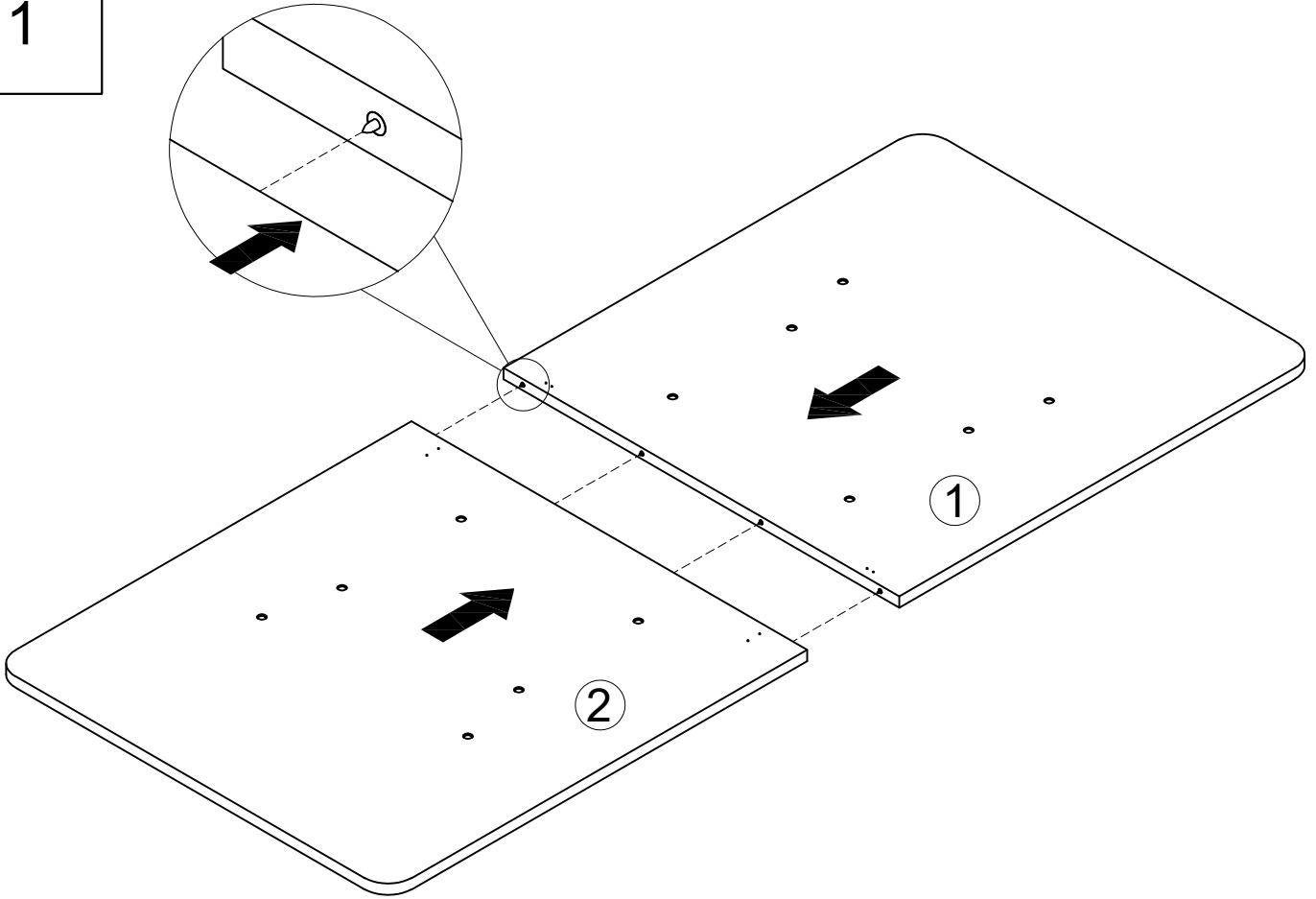

2

Dx8

Jx8

Kx8

Px1

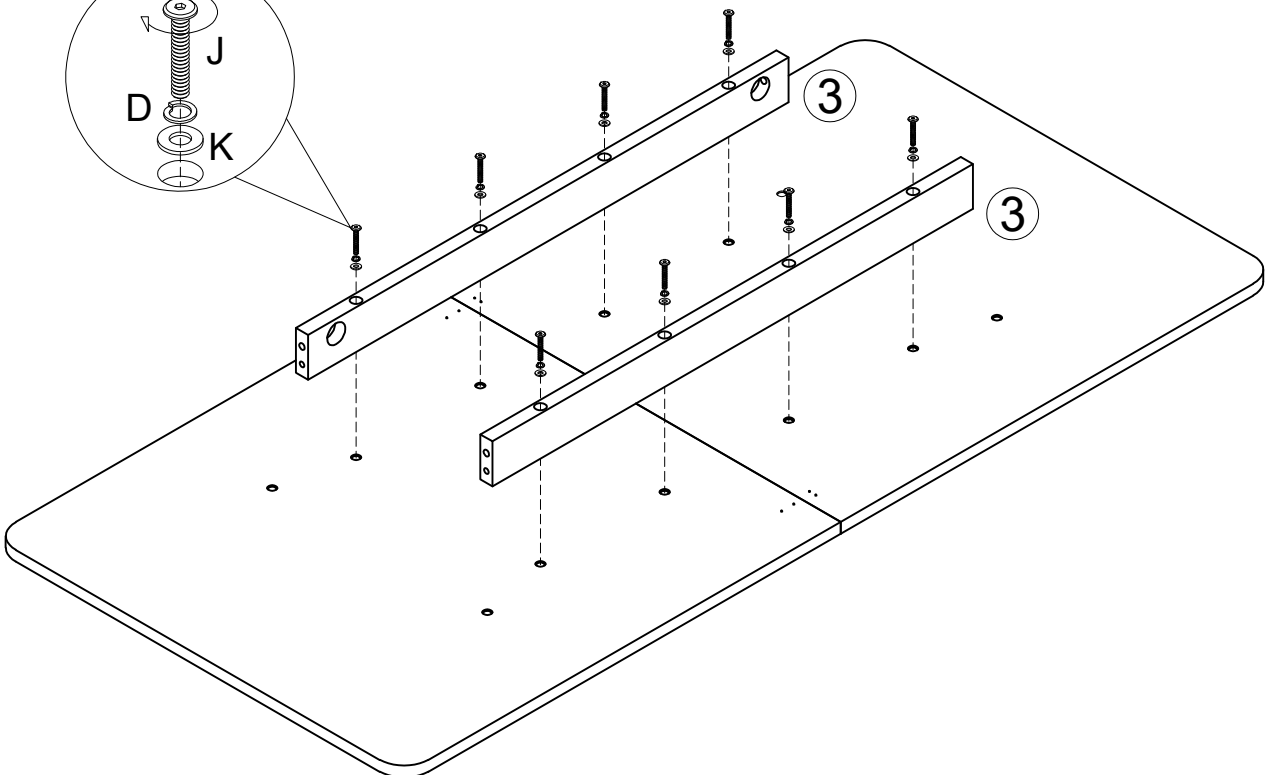
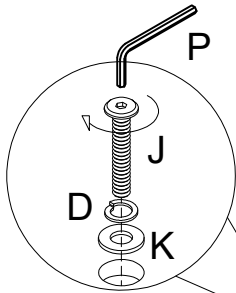
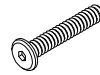

3

Ax4



Bx4



Cx4



Dx4



Ex4



Nx1

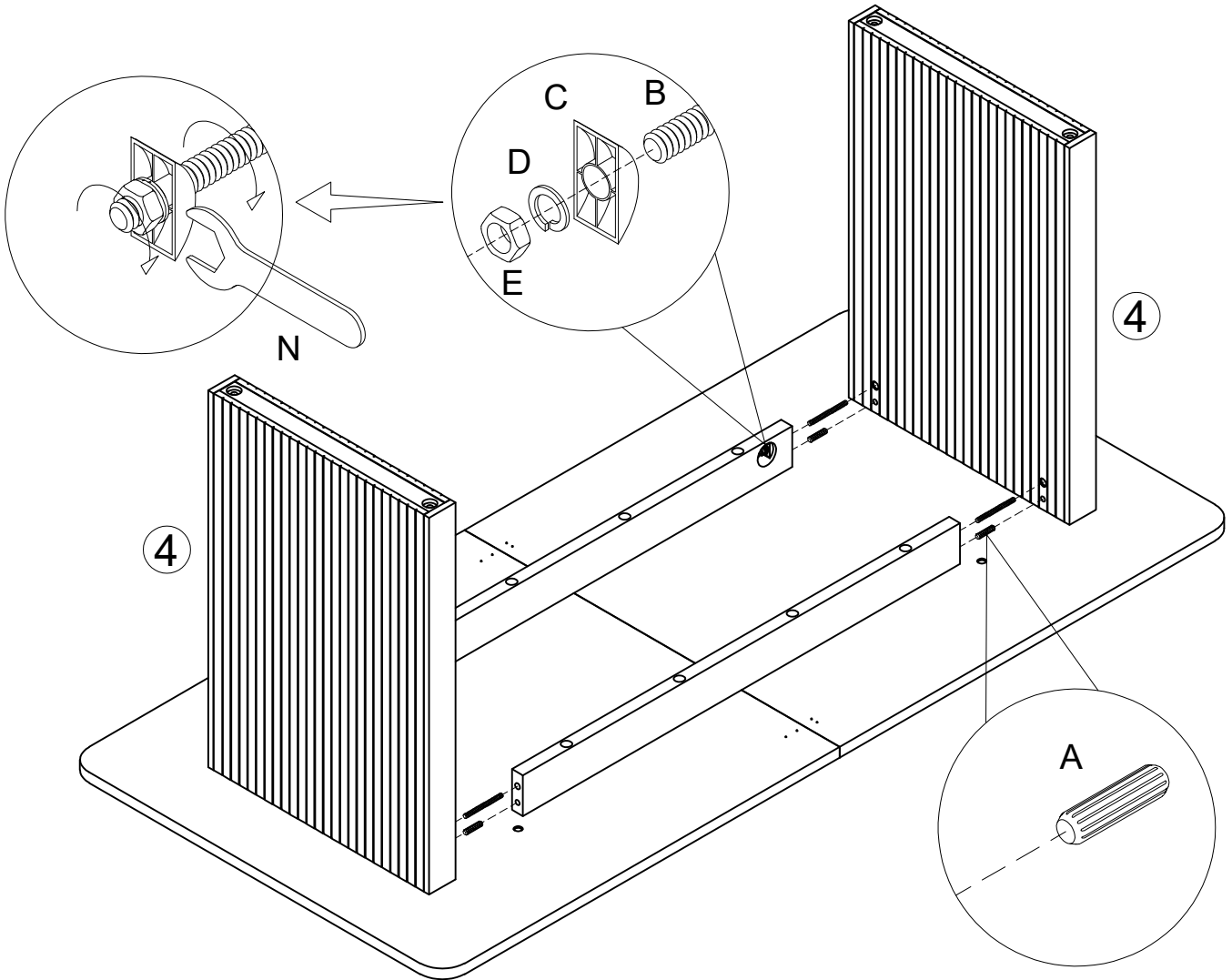

4

Fx4



Gx4

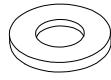

Hx4



Ix4

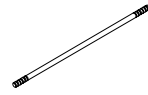

P

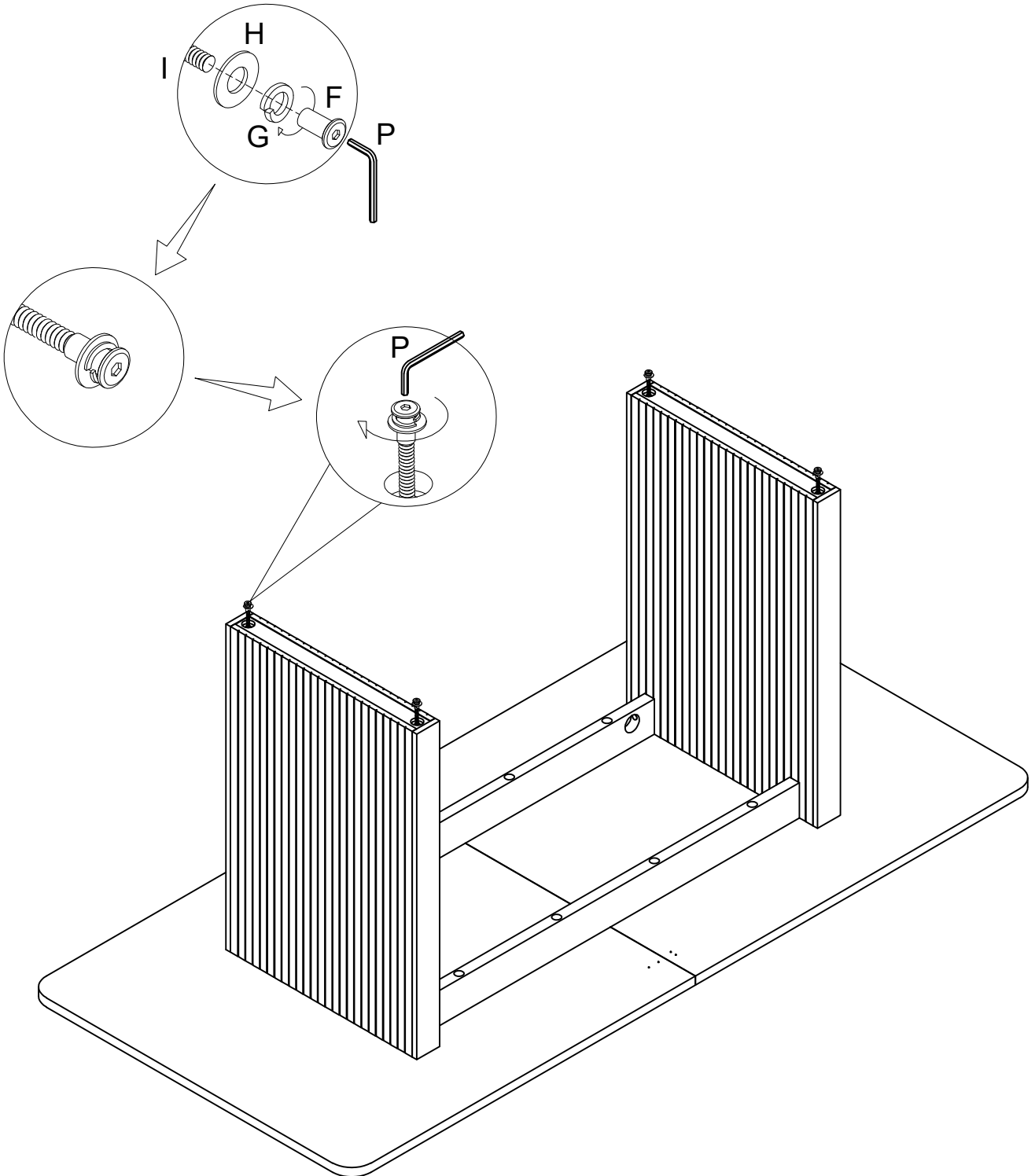

5

Lx2



Mx8



Ox1

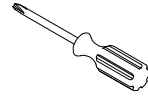

Qx4

