

TOOLS REQUIRED



240 LBS
CHAIR
CAPACITY



1 PERSON
ASSEMBLY



APPROXIMATELY
20 MIN.
ASSEMBLY

HARDWARE

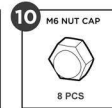
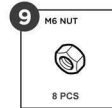
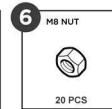
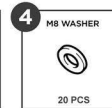

PARTS

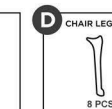
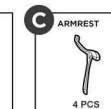
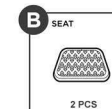

Thank you for choosing our product. If you have any questions, comments or concerns please feel free to contact us by phone, by email, or you could also email us via our contact us page.

We stand behind our brand and the quality of the items we sell. We will send new parts, or replace products at our discretion within the one year warranty period. Before we can help, you will need to provide proof of purchase with the date of purchase and photos of the defective merchandise. We will use the photos to determine the cause of defect and for future quality control.

CHAIR ASSEMBLY

Please retain these instructions for future reference.

1

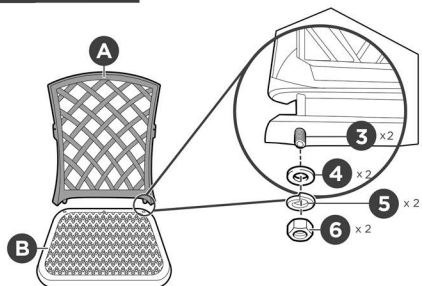

Insert the part A backrest into the part B seat and secure it with two part 3 fastener, two part 4 washers, two part 5 spring washers, and two part 6 nuts.

2

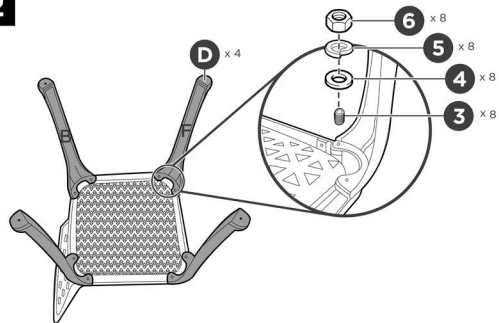

Attach four part D chair legs with eight part 3 fastener, eight part 4 washers, eight part 5 spring washers, and eight part 6 nuts—two washers, spring washers, and nuts per leg.

CHAIR ASSEMBLY

3

Attach the top of a part C armrest with a part 1 bolt, part 7 washer, part 8 spring washer, part 9 nut, and part 10 nut cap.

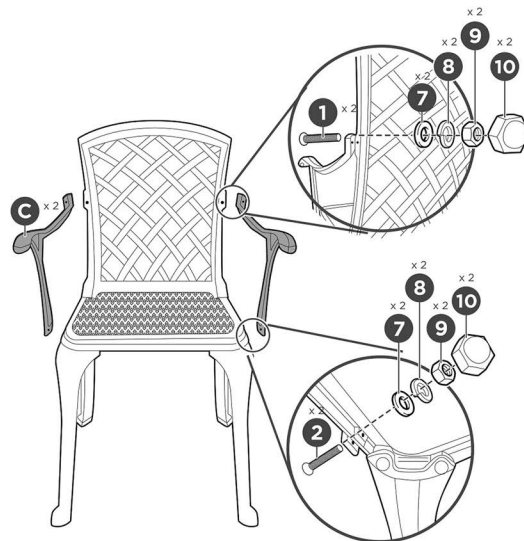

Attach the bottom of the armrest with a part 2 bolt, part 7 washer, part 8 spring washer, part 9 nut, and part 10 nut cap. Repeat to attach the other armrest.