

OLIVER

Storage Bed

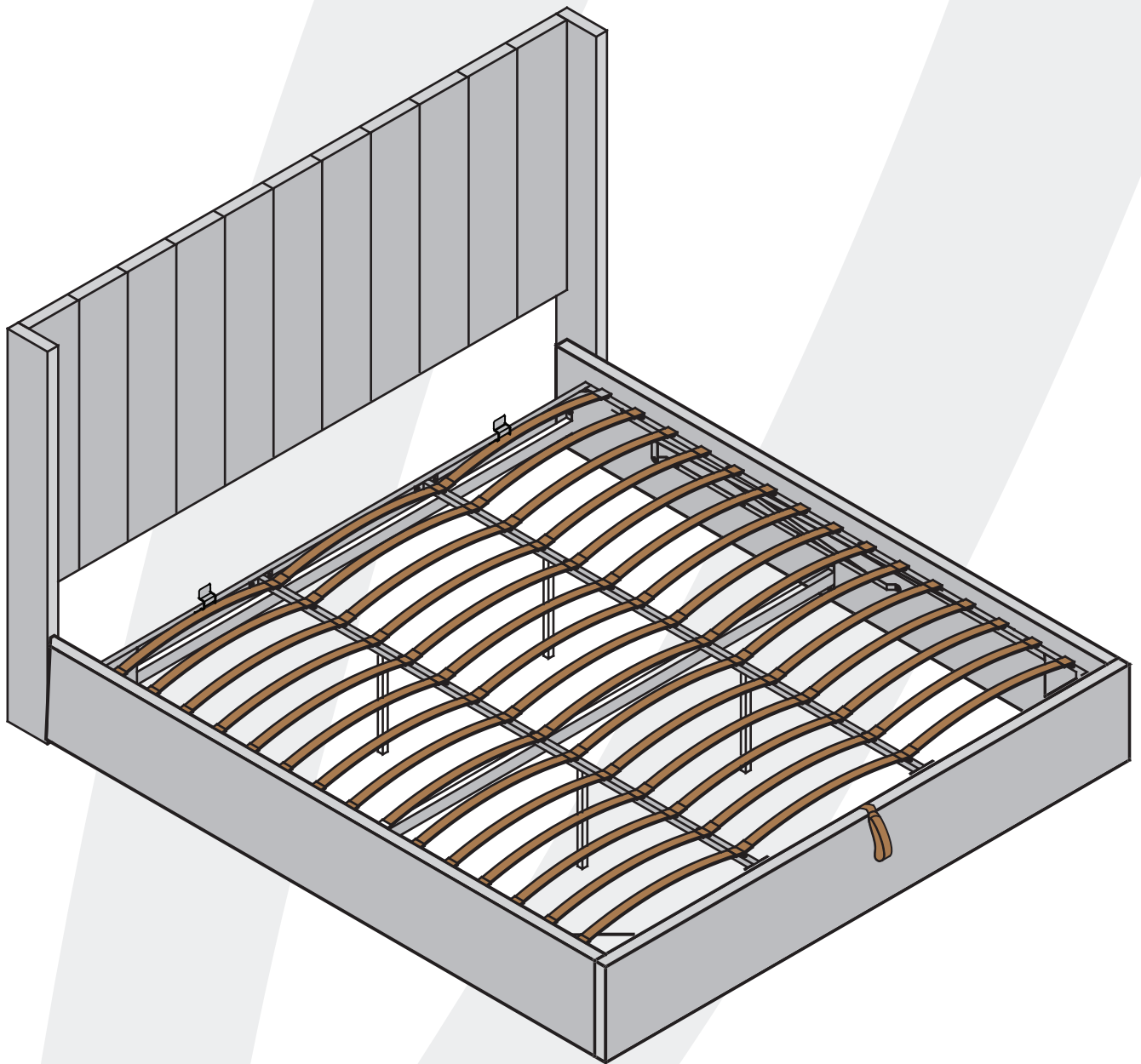



SAFETY PRECAUTIONS

PLEASE READ ALL INSTRUCTIONS CAREFULLY BEFORE ASSEMBLING AND USING THE PRODUCT.

1. Please check all parts are present. In case of missing or damaged parts, use the QR code **“Report an Issue”** so that we can send you the parts you need immediately.
2. For ease and speed of assembly. We recommend that you should identify all parts required for assembly before commencing each step.
3. Please ensure that you have sufficient space and people to assemble your product safely & perfectly on a flat surface.
4. We recommend that all assembled parts should be placed near from the assembly location to avoid loss or forgetting while assembling.
5. For larger items, we recommend that should be assembled where they are expected to be placed to minimize unnecessary movement.
6. It's recommended that the floor should be covered with cardboard or plastic to avoid damage.
7. In each step, do not tighten bolts/screws completely until all bolts/screws are lined up and tightened 80% separately. Do not over tighten bolts/screws to avoid stripping.
8. Do not stand on the product. Do not use the product as a step ladder.
9. This product is intended for indoor, household use, please do not put it outdoors.



2 Hours
Assembly Time



POWER TOOLS
No Power Tools Required



2 PEOPLE
Required For Assembly



HARD
Level of Difficulty









Thank you for making a purchase with Velets. The goal of this assembly sheet is to help you assemble the product in a way that will contribute to its longevity and durability. Read these instructions carefully and keep for future reference. Refer to parts inventory for guidance, and ensure you have all pieces before starting.



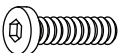

A few important things to note:









1. Please do not use a power tool to assemble this product. Using one may hinder and/or damage the item and will invalidate any claims for warranty.
2. Depending on the amount of use this product receives, it may be recommended to tighten up the fixings from time to time. This is completely normal!

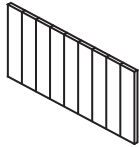

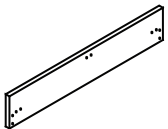

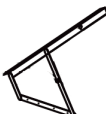

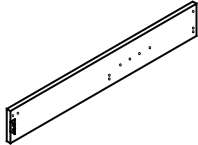
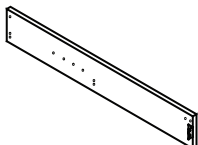
When assembling, place all parts on a soft, clean, and flat surface such as a carpet to prevent scratches. If you face any difficulty, our friendly customer care team is always here to help. Call us at 1.800.484.7050 during business hours, email support@velets.com.

All parts & hardware is placed at the back of the Headboard, please remove the back cover to find the parts

PARTS INVENTORY			
ID	DESCRIPTION		QTY
A	M6*20 BOLT		12
B	M8*25 BOLT		22
C	M8*45 BOLT		30
D	FLAT WASHER M8		44
E	SPRING WASHER		12
F	FLAT WASHER M6		12
G	NUT M8		20
H	ALLEN KEY		1

PARTS INVENTORY			
ID	DESCRIPTION		QTY
I	OPEN SPANNER		1
J	PROTECTIVE PAD		10
K	MATTRESS STOPPER		2
L	BLACK PIN		8
M	BLACK LEVELING FEET		2

PARTS INVENTORY		
ID	DESCRIPTION	QTY
1	Headboard 	1
1-1	Right Wings 	1
1-2	Left Wings 	1
2	Footboard 	1
3	Left Gas Lift Frame 	1
4	Right Gas Lift Frame 	1
5	Gas Lift Machine 	2
6	Right Siderails 	1
7	Left Siderails 	1
8	Wood Slat 	45
9	Single Close Ended Clip 	30

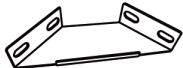
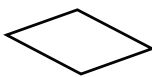
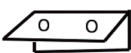
PARTS INVENTORY		
ID	DESCRIPTION	QTY
10	Double Open-Ended Clip 	30
11	Side Rail Metal Bar 	2
12	Headboard and Footboard Metal Bar 	2
13	Side Rail Connector Metal Bar 	2
14	Middle Metal Bar 	2
15	Support Legs 	4
16	Gas Lift Strap 	1
17	Gold Corner 	2
18	Black Nonwoven Fabric 	1
19	Black Back Plate 	1

1

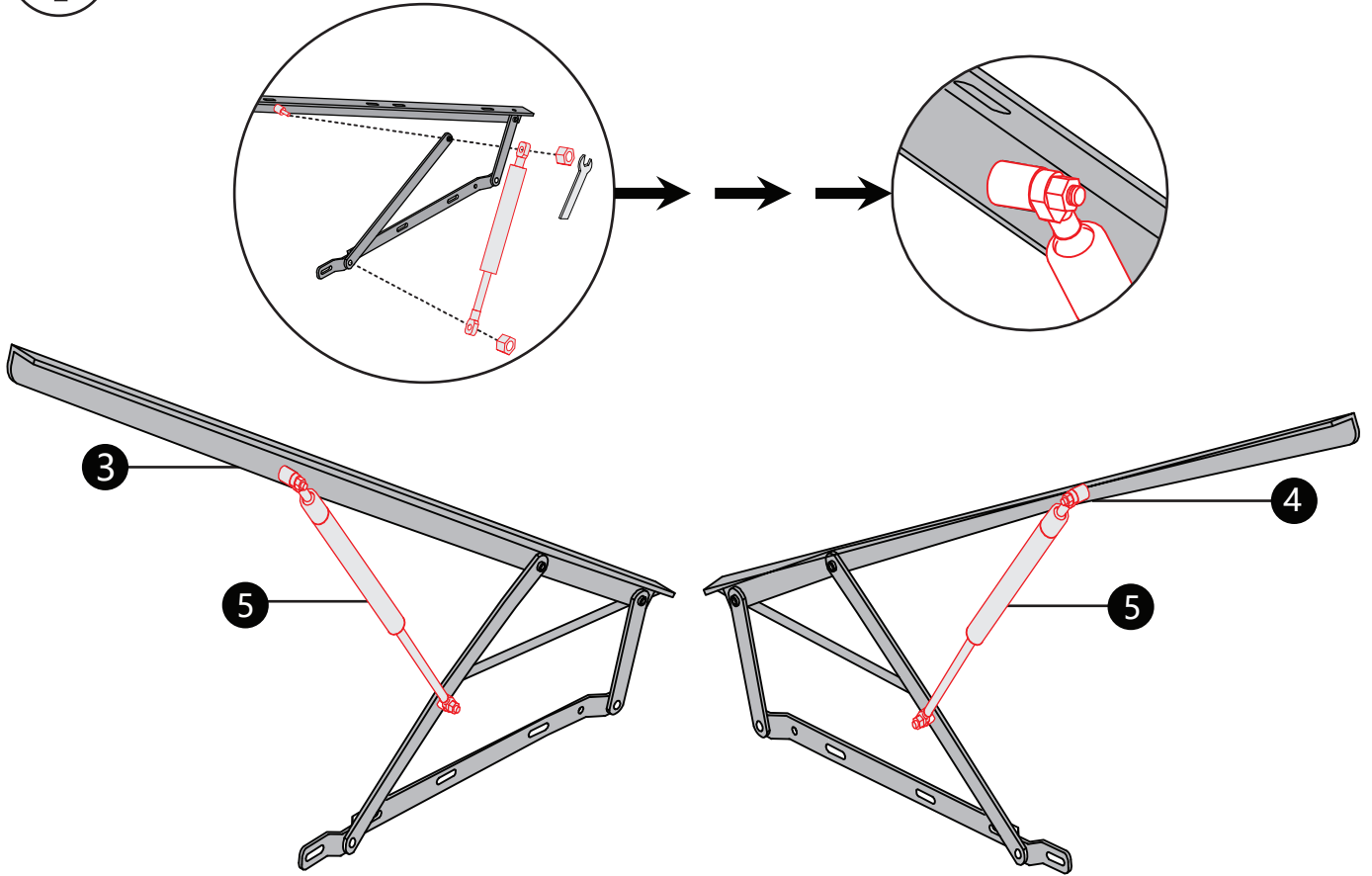

2

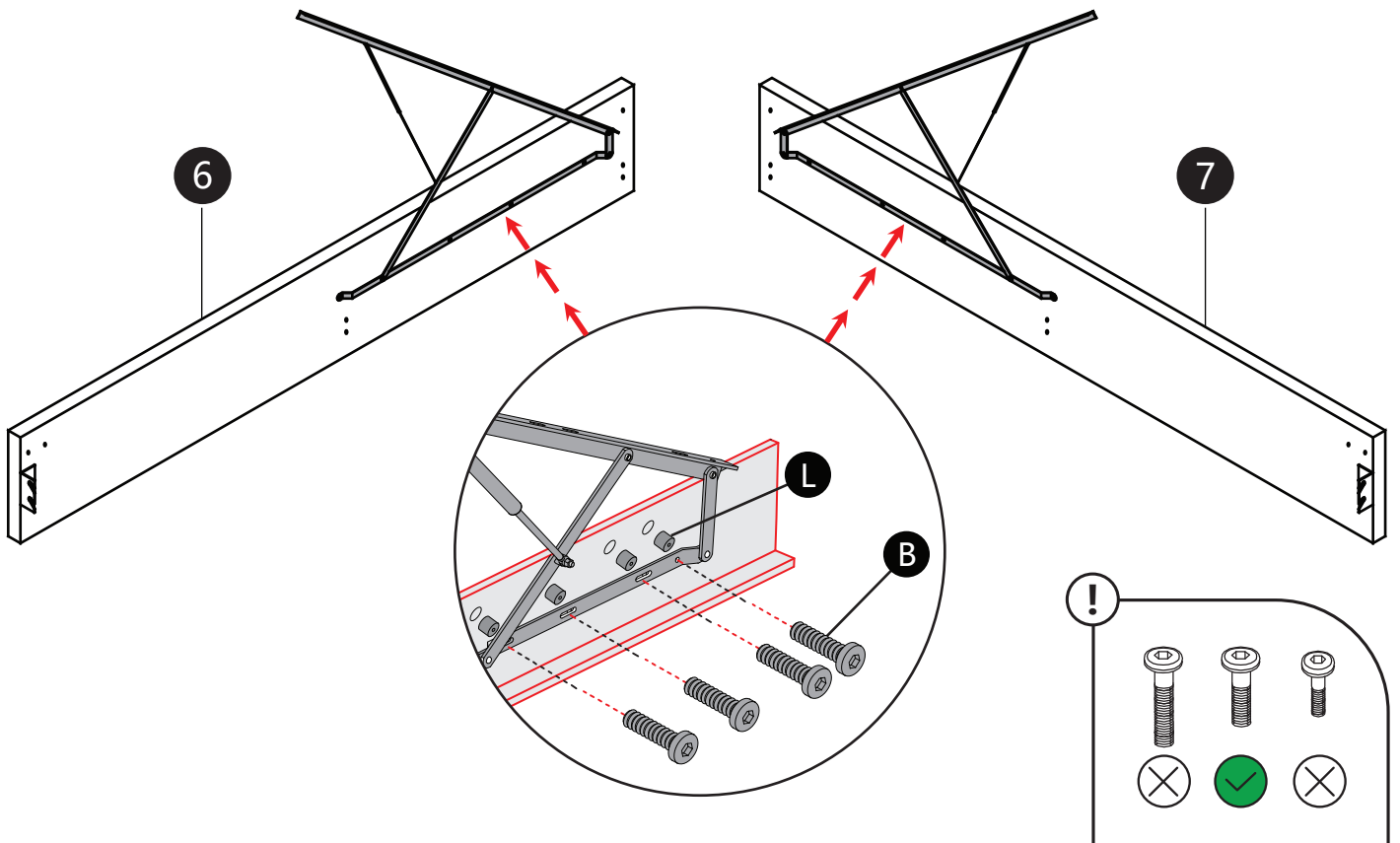

3

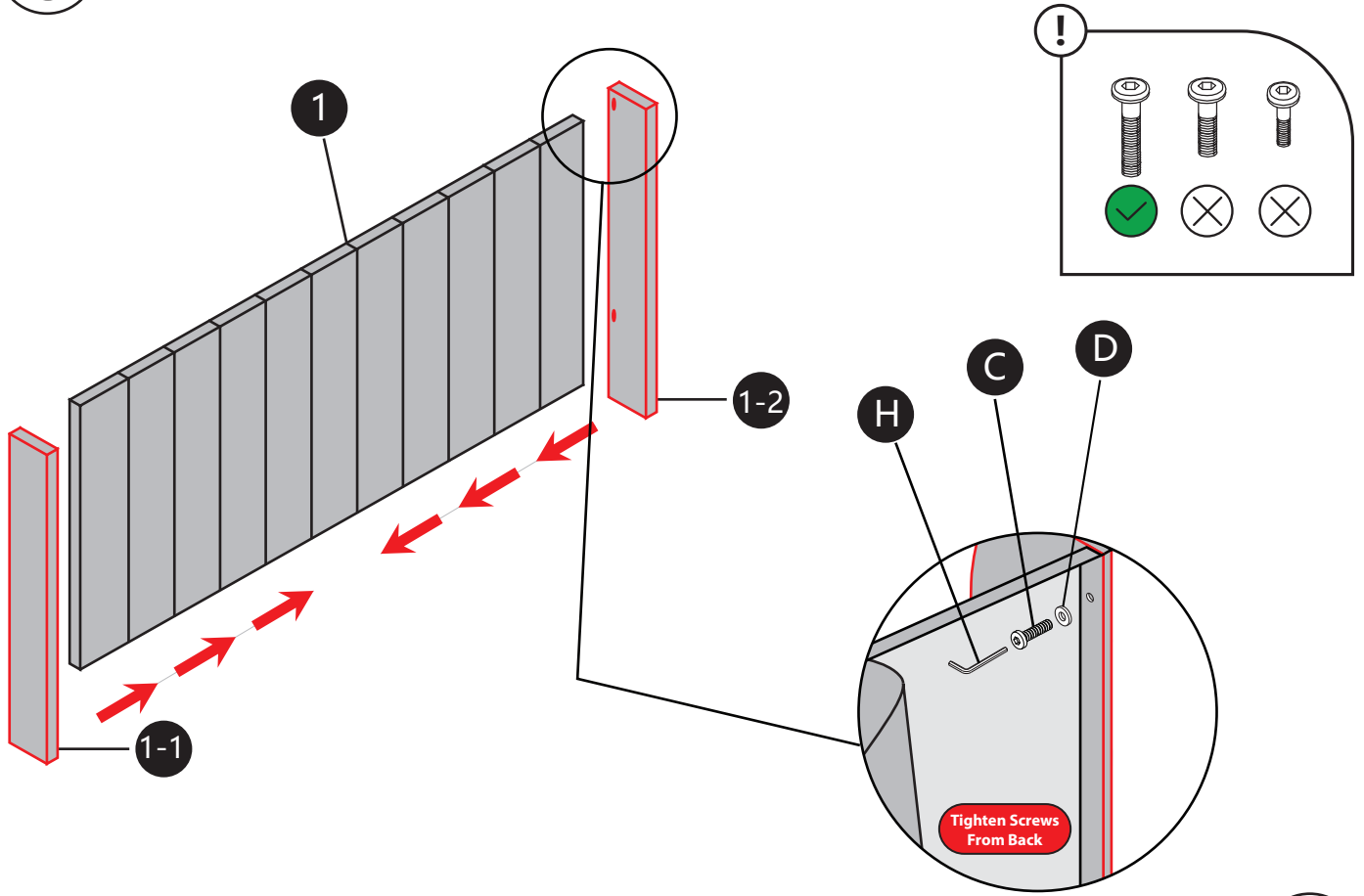

4

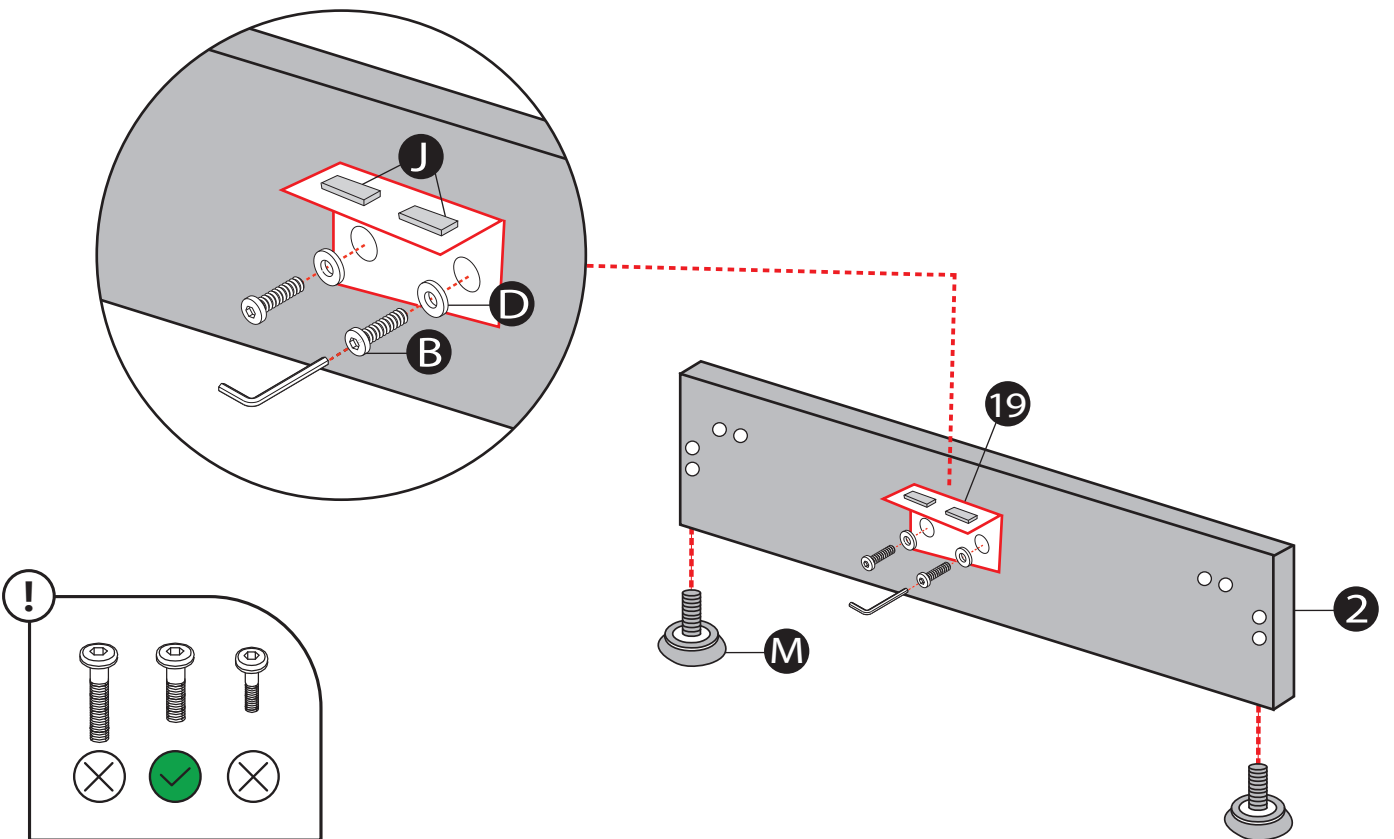

5

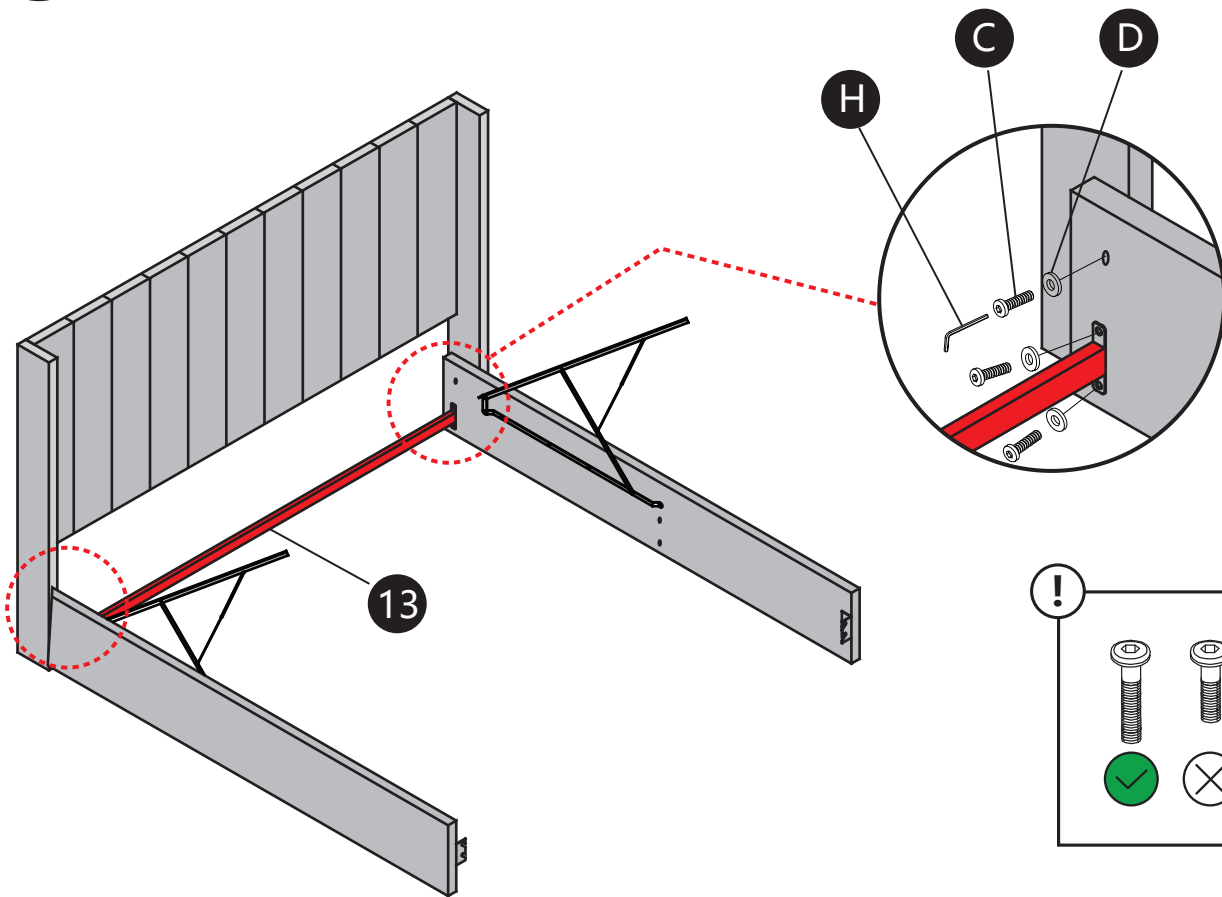

6

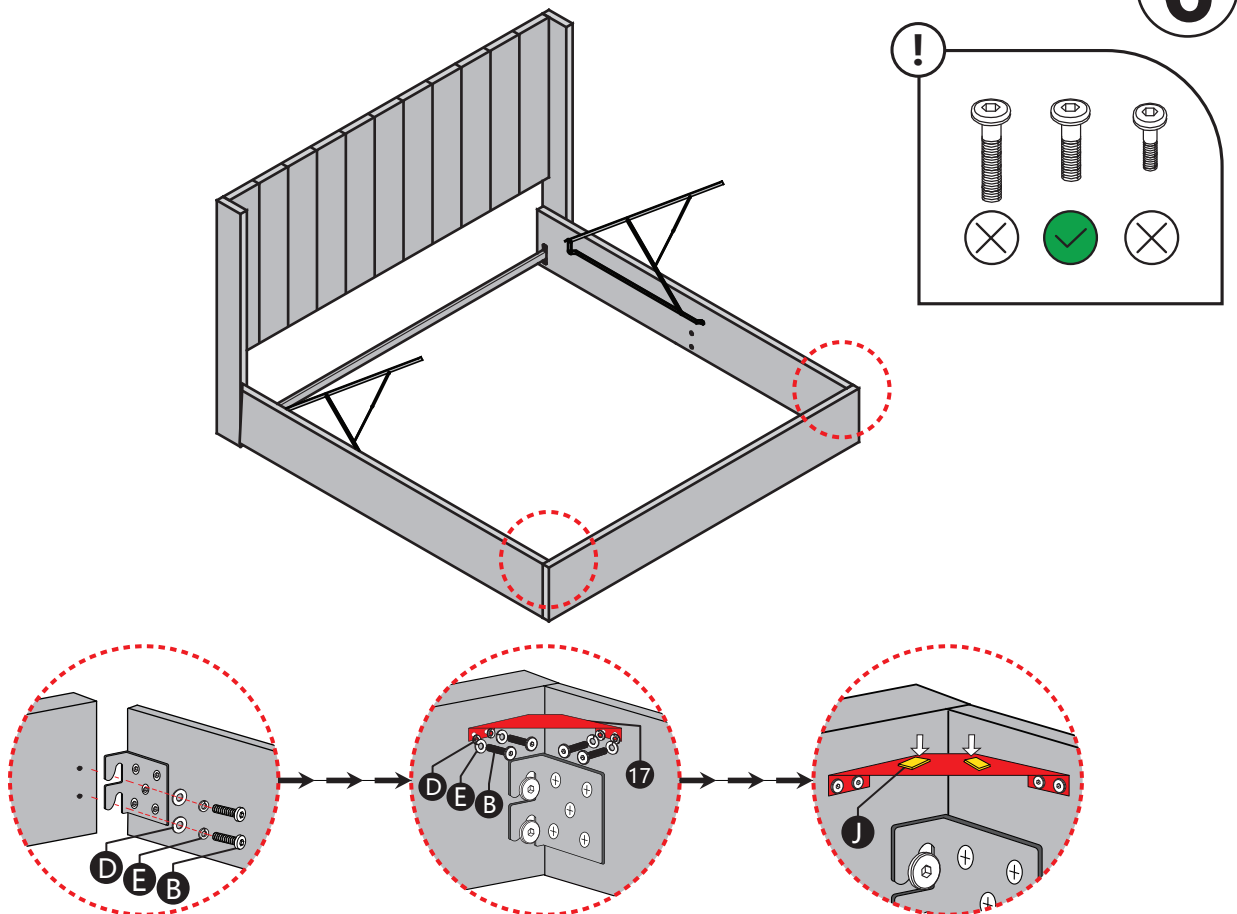

7

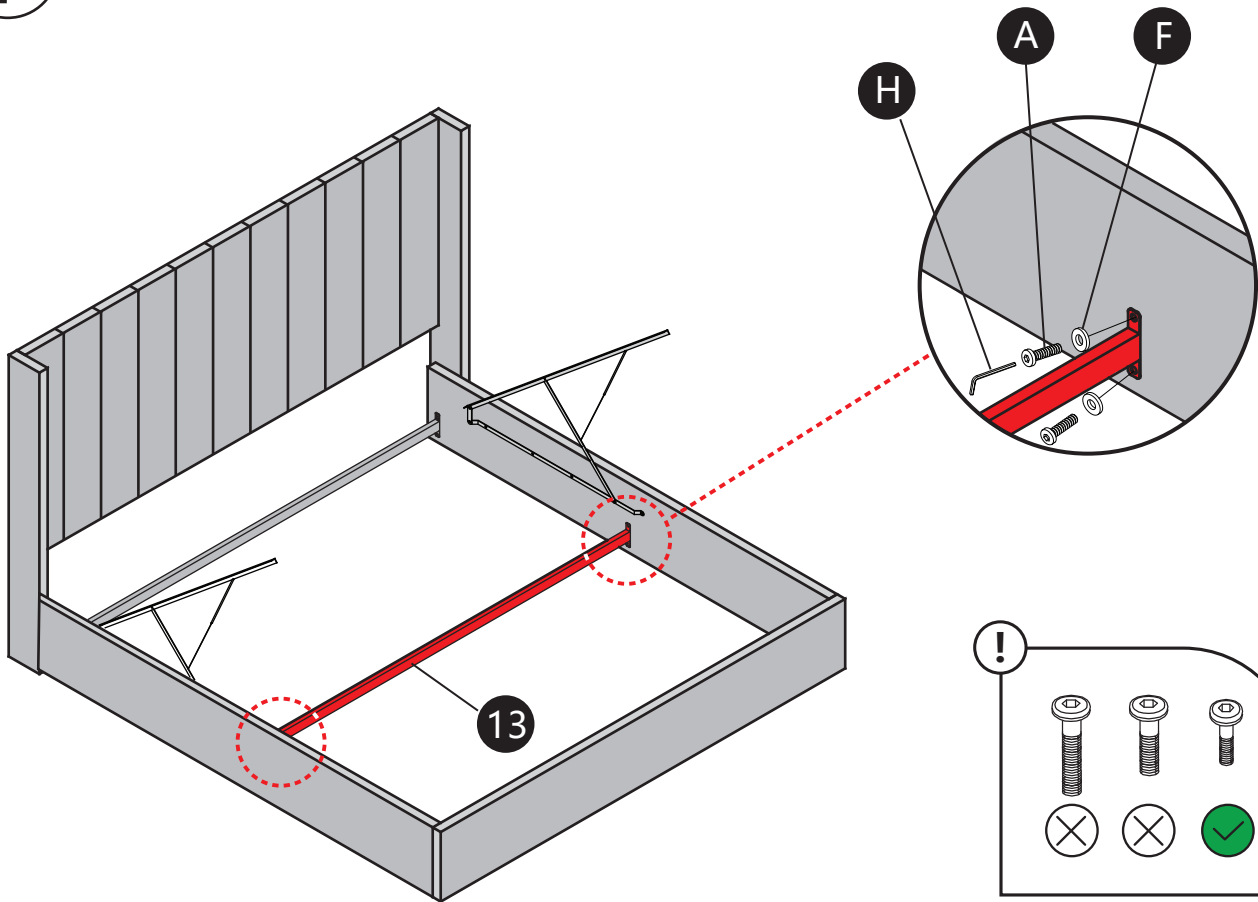

8

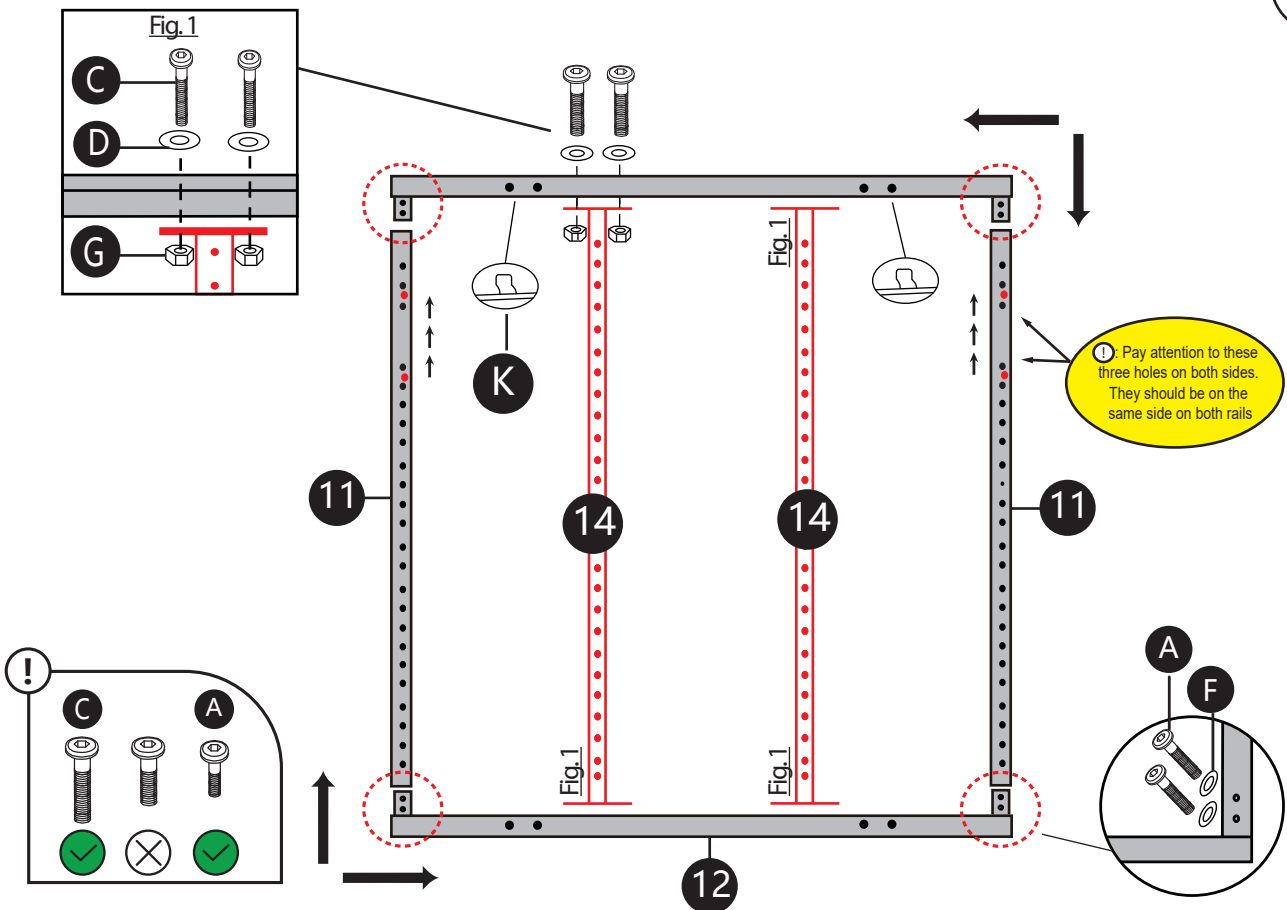

9

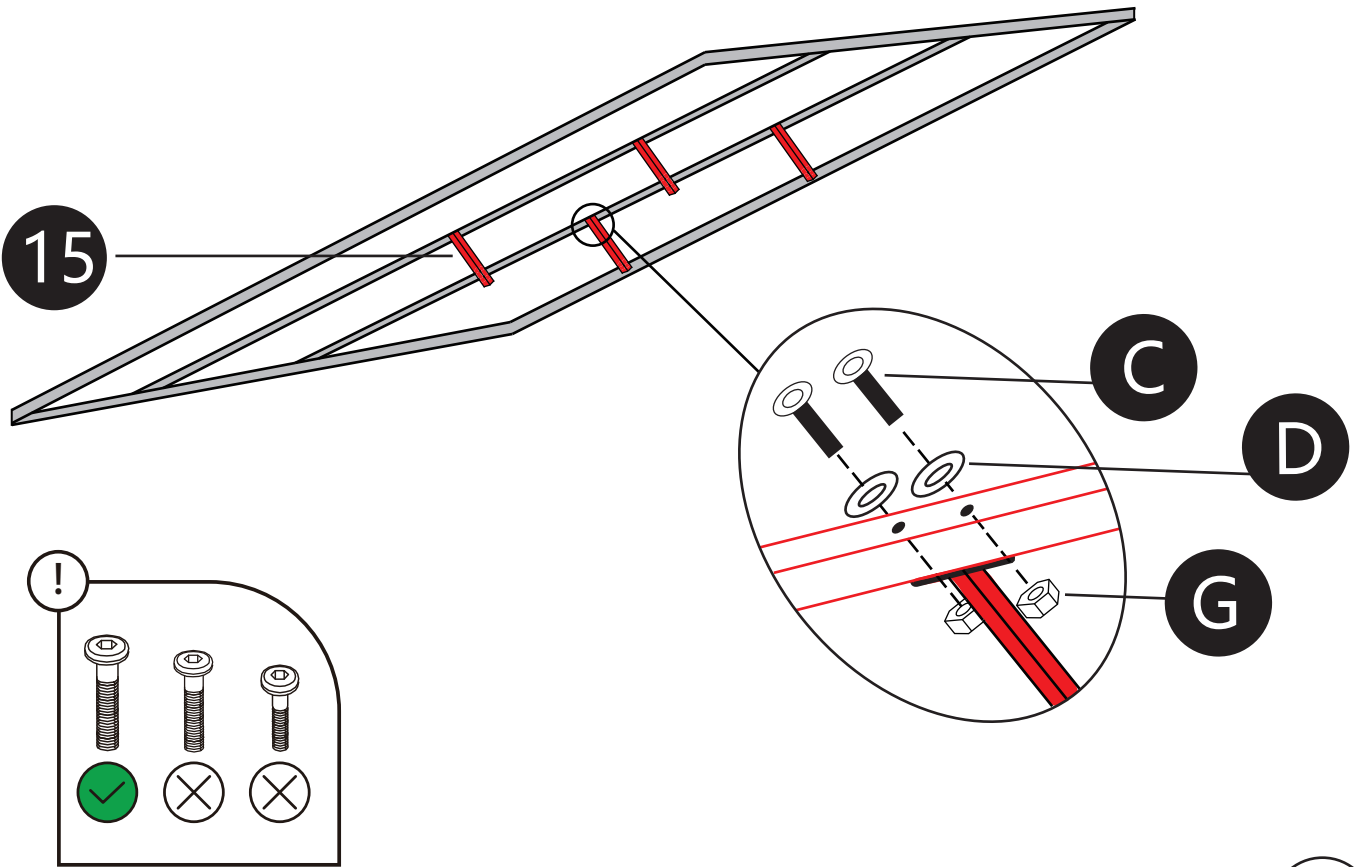

10

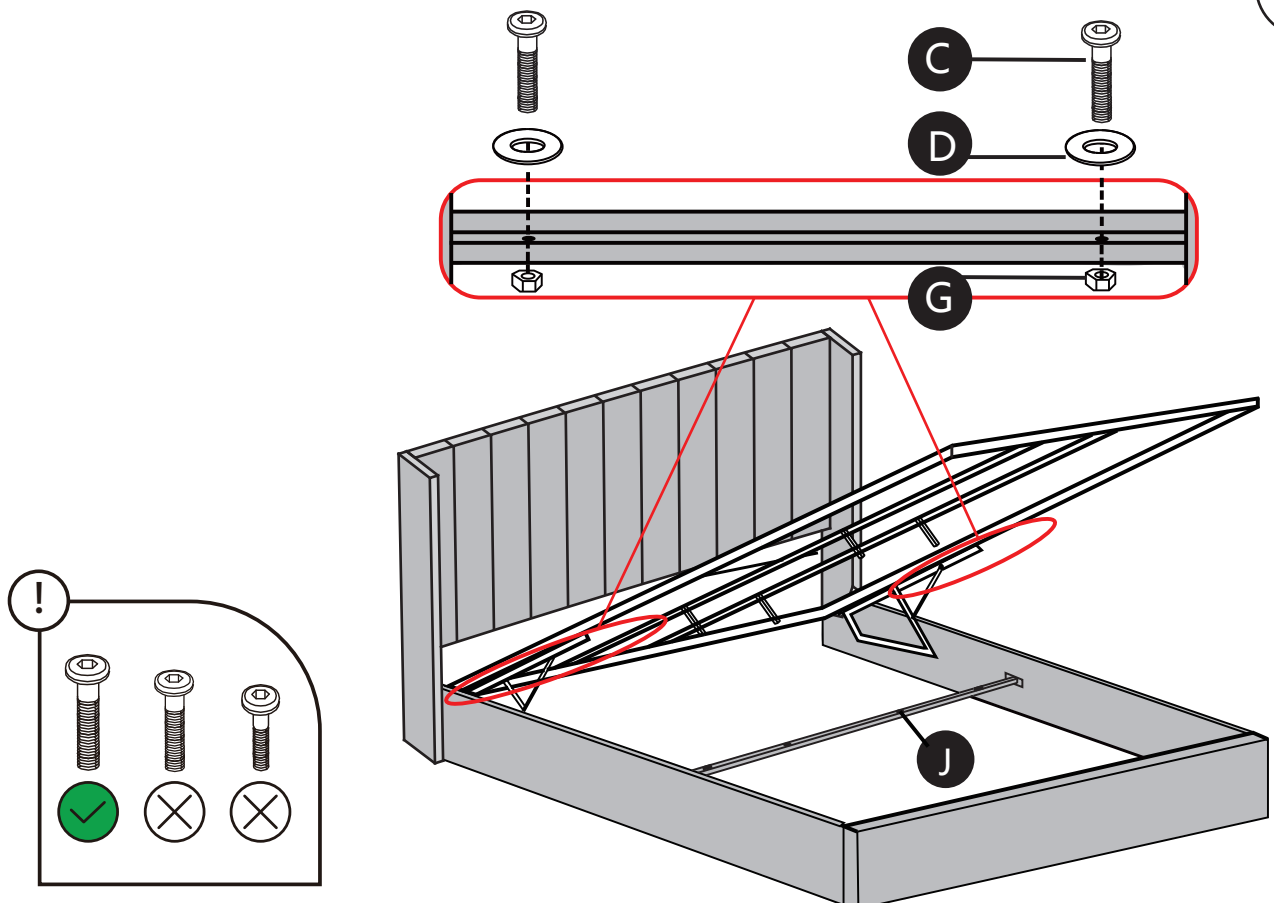

11

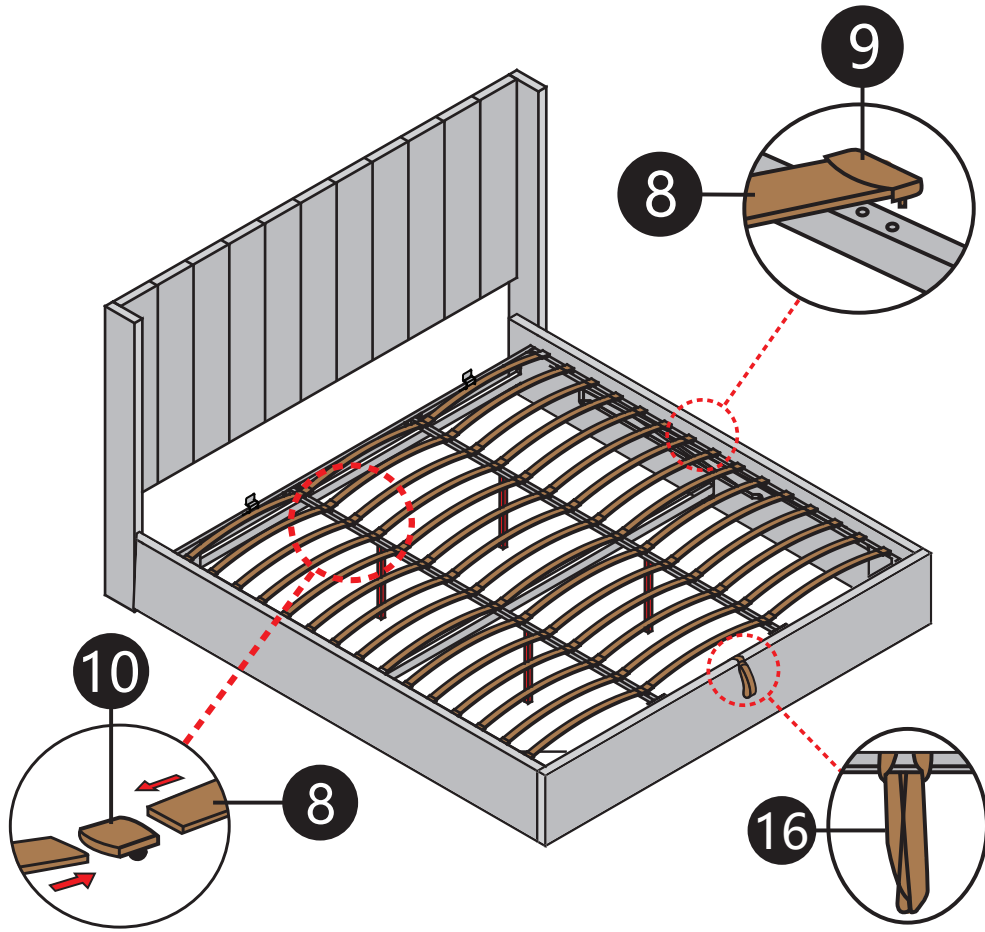

12

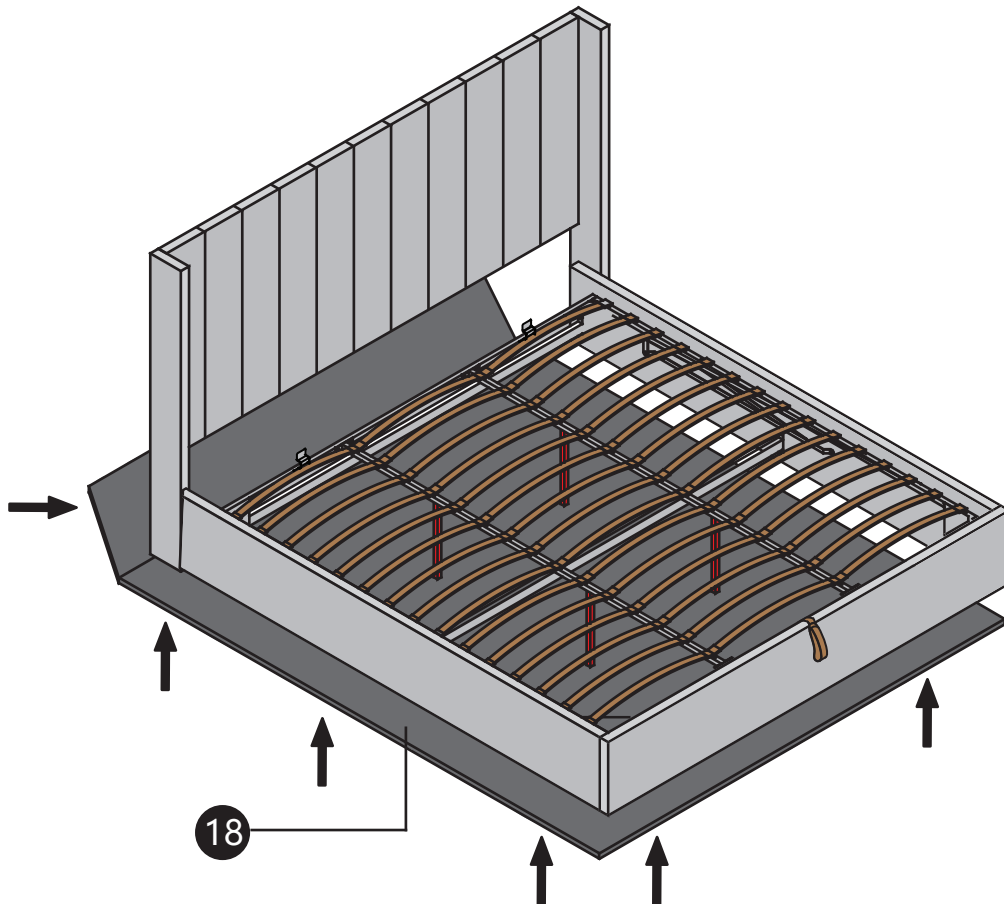

Warranty Information

Version 1.0

How long is the warranty valid?

The warranty for new Velets products remains in force for 6 months. The warranty is valid from the date of purchase. The original purchase receipt is required as proof of purchase.

Products and parts not covered under this warranty:

- Fabric covers
- Leather covers
- Coated fabric covers

What is covered under this warranty?

This warranty applies to residential use only and covers defects in material and workmanship in frames, seat and back cushions when used with the intended frames. This warranty becomes valid only after the return window has expired. Please read this Limited Warranty carefully. You must follow these guidelines in order to keep your Warranty valid. If your product is proven to be defective due to poor manufacturing or structural defects other than the specified restrictions set forth herein, we will, at our discretion, replace it or issue you a prorated refund.

Only the product itself is covered by the manufacturer's warranty and financial liability; anything that might be used with the purchased product is not covered. Only manufacturing defects are covered by this warranty; misuse-related damages are not. Manufacturing defects include circumstances where the product has broken under normal use. In the event you encounter a manufacturing defect, please stop using this product immediately and call customer service.

Only the original purchaser, who is the first purchaser of the product according to the original sales receipt or invoice and who

purchased the product directly from Velets as a new product, is eligible to take advantage of this warranty. Please keep your original invoice as it is mandatory and the only accepted proof of purchase.

The warranty applies only when the product has been properly used by the original purchaser. Proper use means that the product was not abused by the consumer, as defined by the manufacturer. This warranty gives you specific legal rights and you may have other rights that vary from state to state.

What is not covered under this warranty?

This warranty does not cover products that have been improperly used, mistreated, misused, improperly stored, assembled, or installed, or cleaned with the incorrect cleaning agents or methods.

Normal wear and tear, scrapes, scratches, and damage from impacts or accidents are not covered by this warranty.

This warranty does not apply if the product has been used outside or in a humid environment.

This warranty does not cover incidental or consequential damage.

How to reach us if you need service?



Scan the above QR code or visit www.velets.com, email us at support@velets.com or call us at 1.800.484.7050