

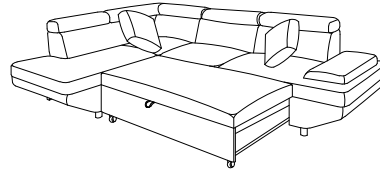









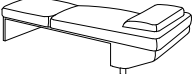
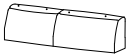









SOFA ASSEMBLY INSTRUCTION



THANK YOU FOR PURCHASING SOFA PART LIST

NO	DRAWING	QTY	DESCRIPTION
A		1	Chaise
B		1	Sofa Seat
C		1	Sofa Back
D		1	Headrest
E		3	Headrest
F		1	Headrest
G		1	Pillow
H		6	Leg
I		4	Wheel
J		1	Left Connecting Piece
K		1	Right Connecting Piece
1		4	5/16" Nut
2		4	5/16 " Flat Washer
3		4	5/16" Lock Washer
4		1	Wrench
5		4	Hang Bolt
6		1	Allen Wrench
7		10	Bolt M6 * 25
8		16	Screw
9		2	K/D Pin

STEP 1:

1. Before assembly the sofa, need to take out the Sleeper Section.
2. Turning the leg into the metal plate on the bottom of the Sofa seat and Chaise.

LEGS AND HEADREST INSIDE

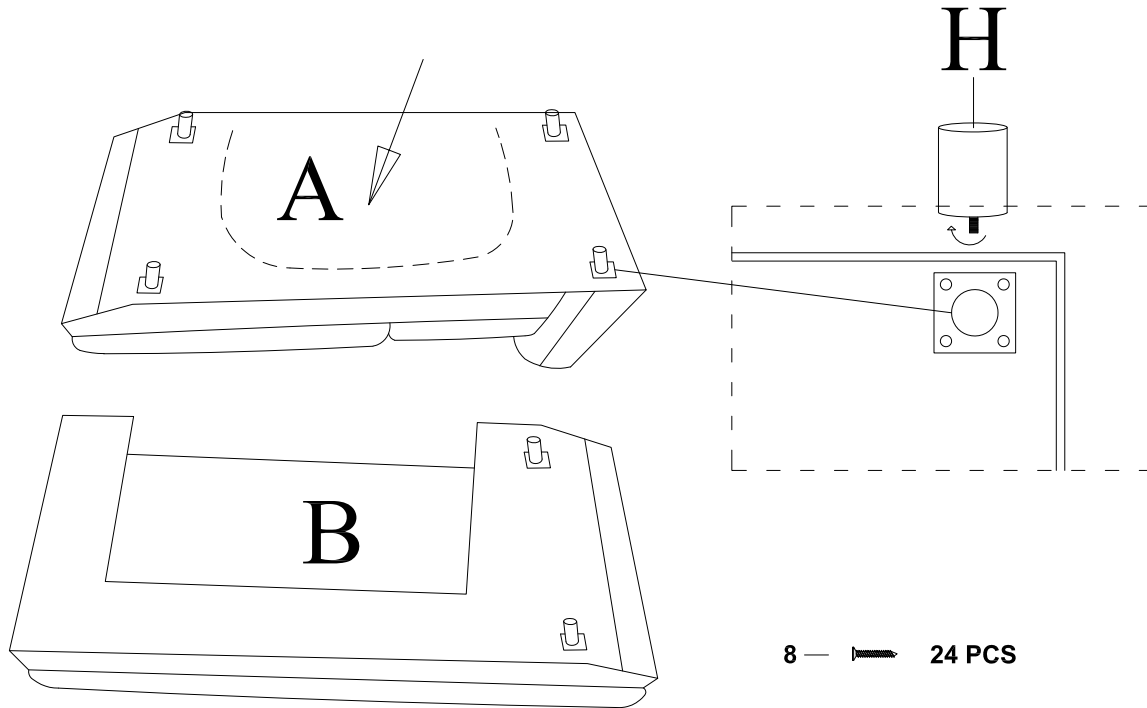

STEP 2:

1. Screw the Hang bolts into bottom of Sofa Back (C) of the Sofa seat (B). Make sure there is enough length of the Hang bolt for next step. As show in Figure 1.
2. Attach the Sofa Back (C) on the Sofa Seat (B) using Flat Washer (2), Lock Washer (3) and Nut (1), tighten with Wrench(4) as show in Figure 2.

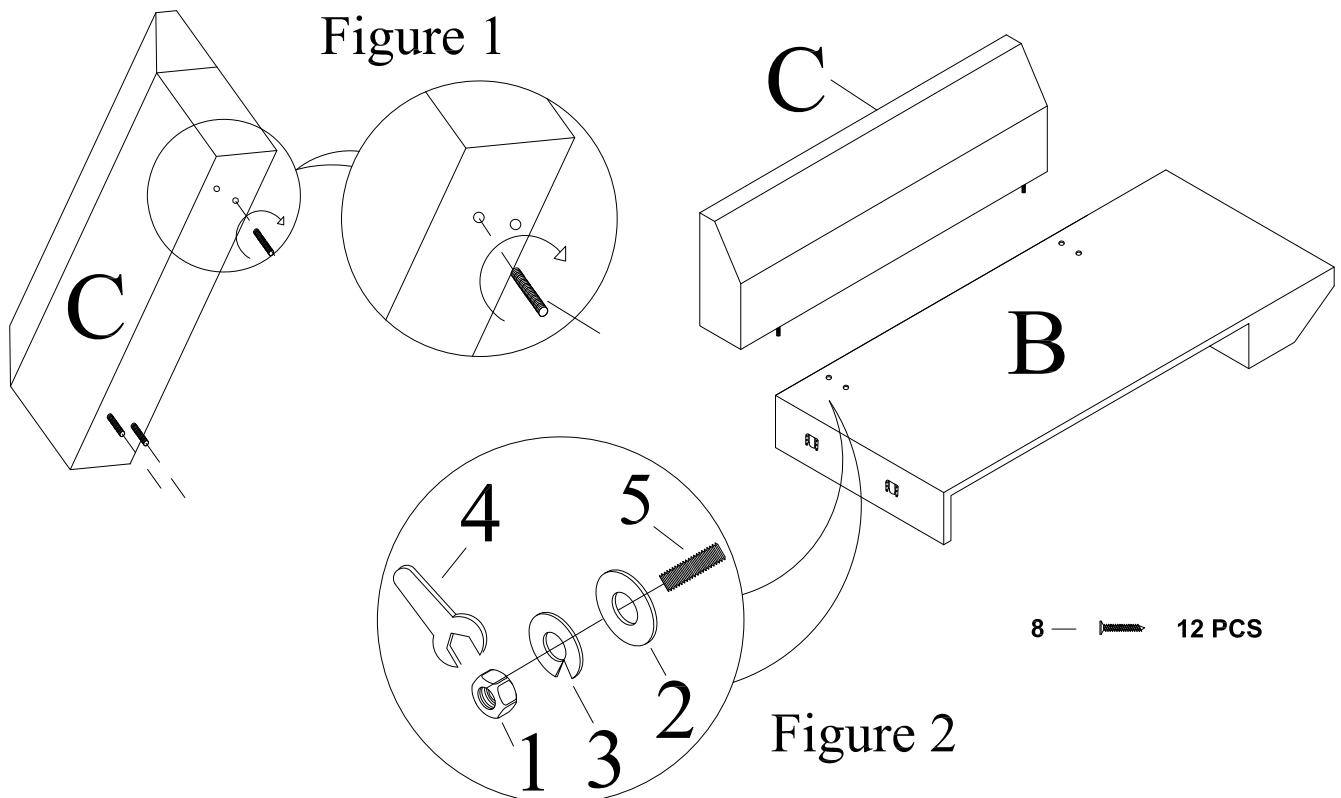

STEP 3:

Assemble the left and Right mechanisms to the Sleeper Cushion.

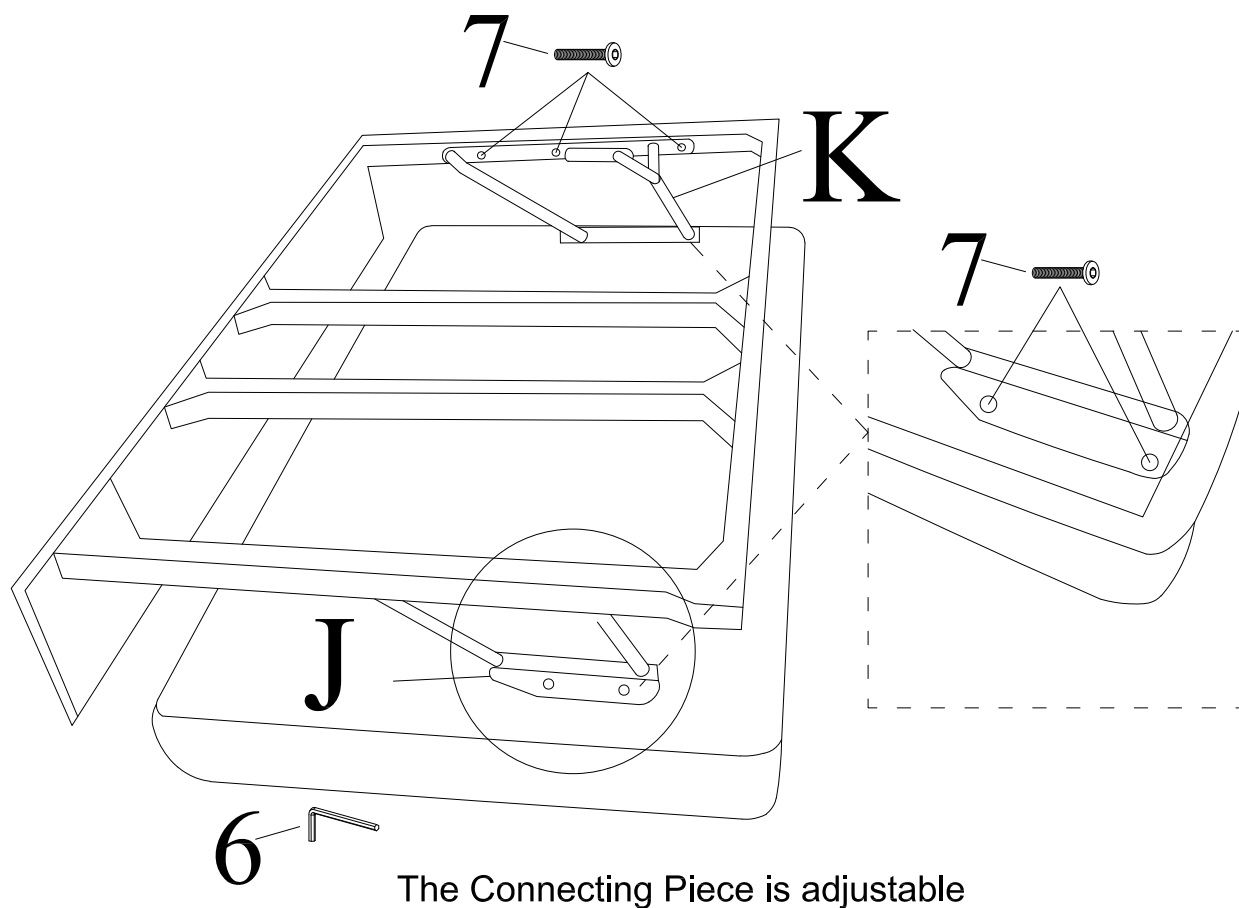

STEP 4:

Assemble the Wheels onto the Sleeper Cushion.

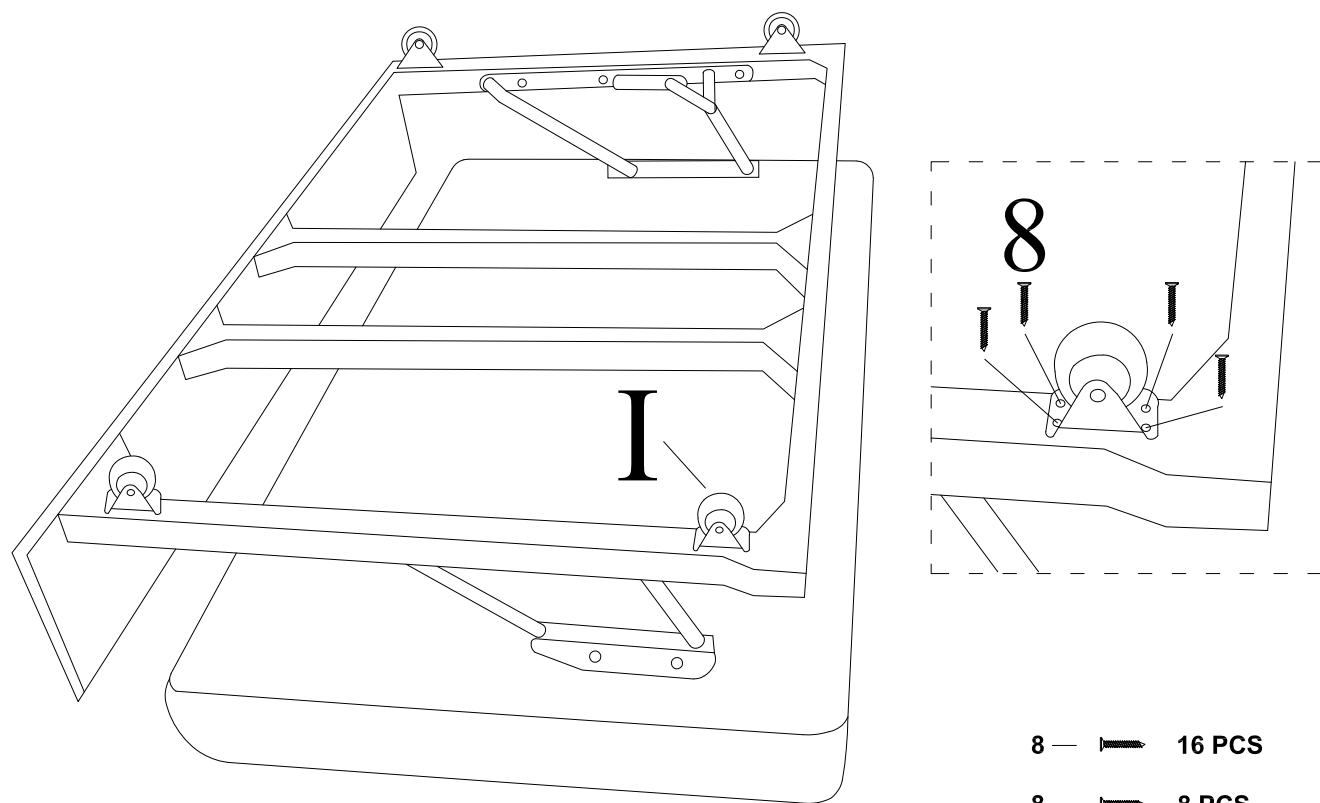

STEP 5:

Insert all the Headrests on the Chaise and Sofa Back, connect the Chaise and Sofa Seat with hooks.

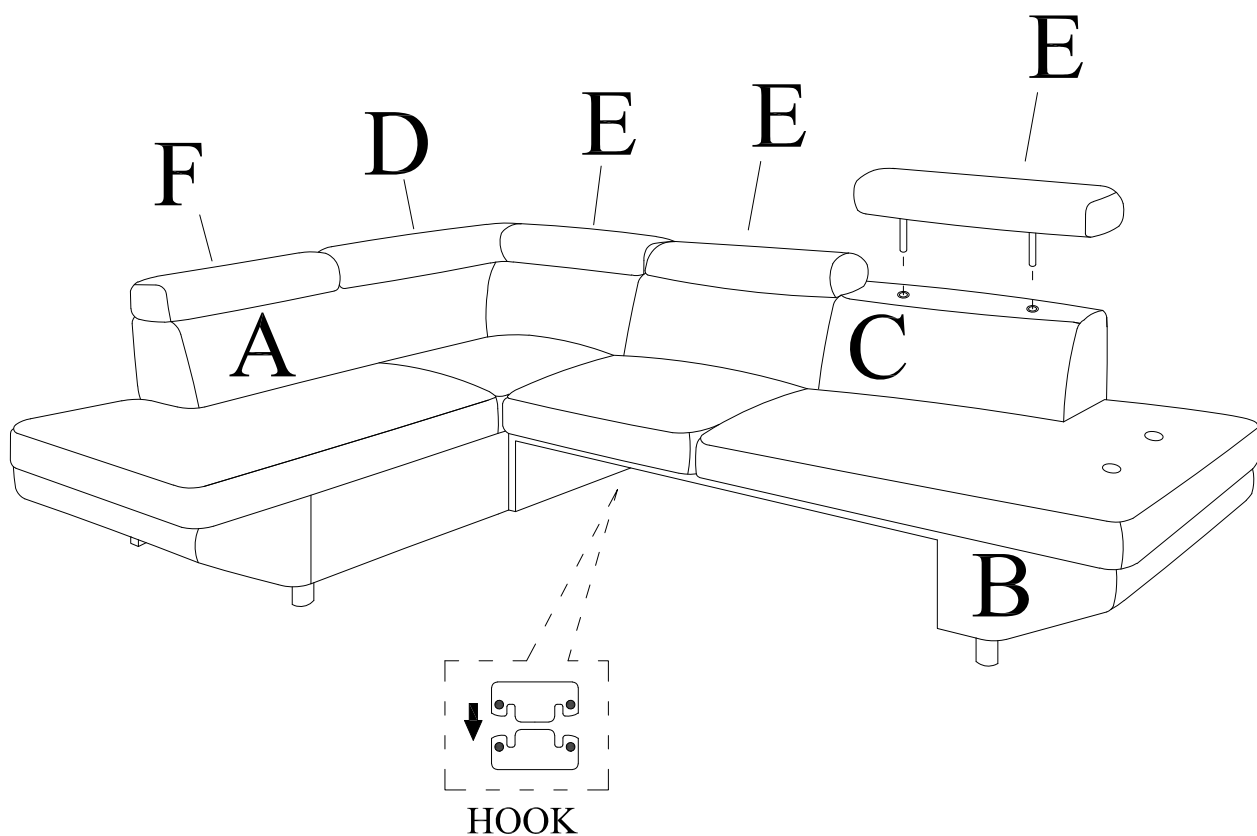

STEP 6:

Assemble the Pin(9) onto the back side

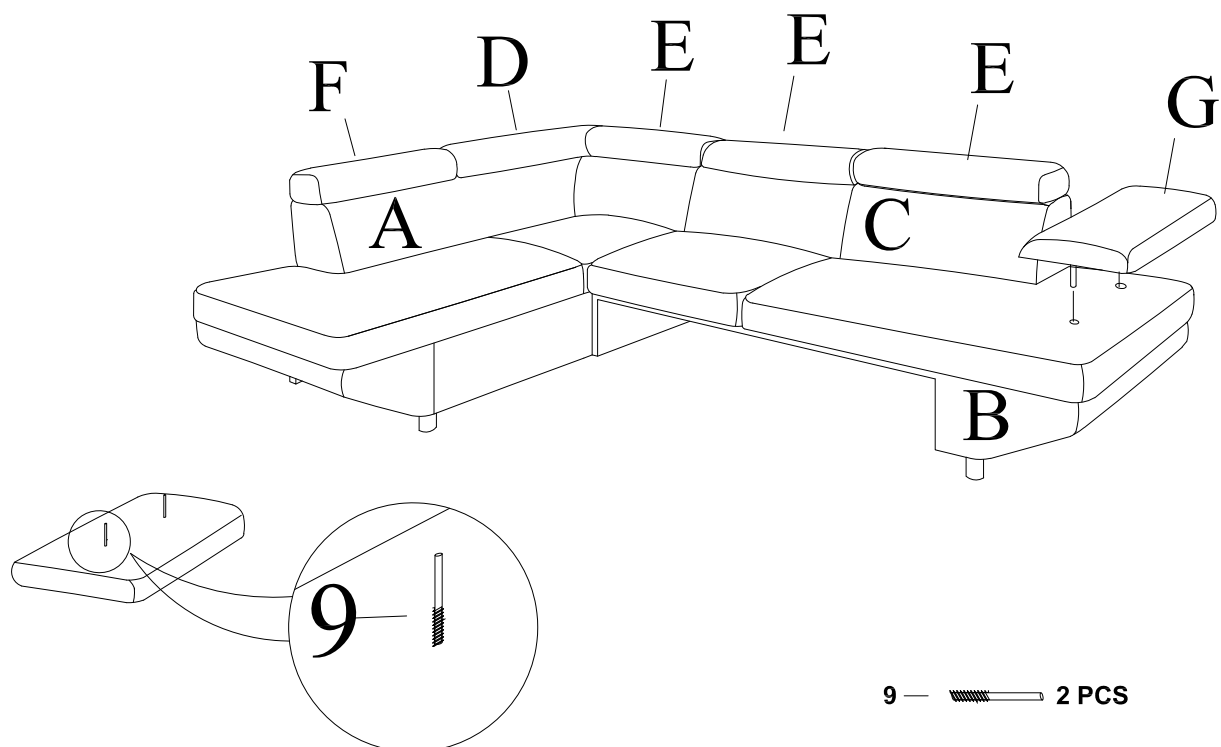

STEP 7:

Move the Sleeper Section to sofa card slot, then push it into Sofa Seat.

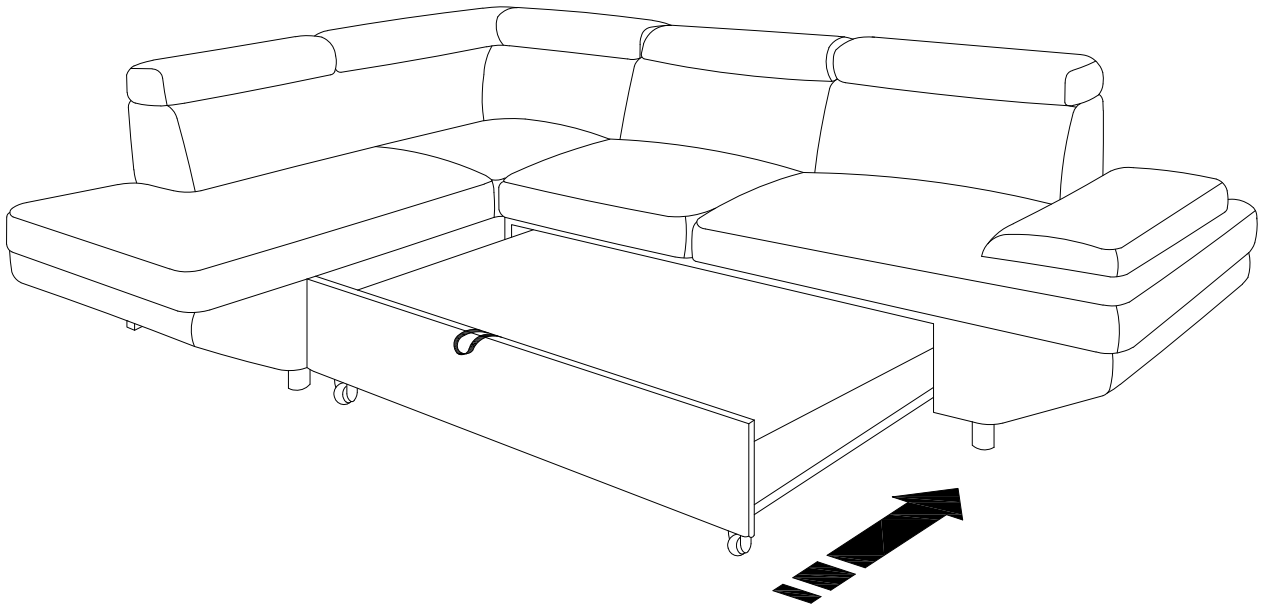

STEP 8:

Pull out the Sleeper Cushion.

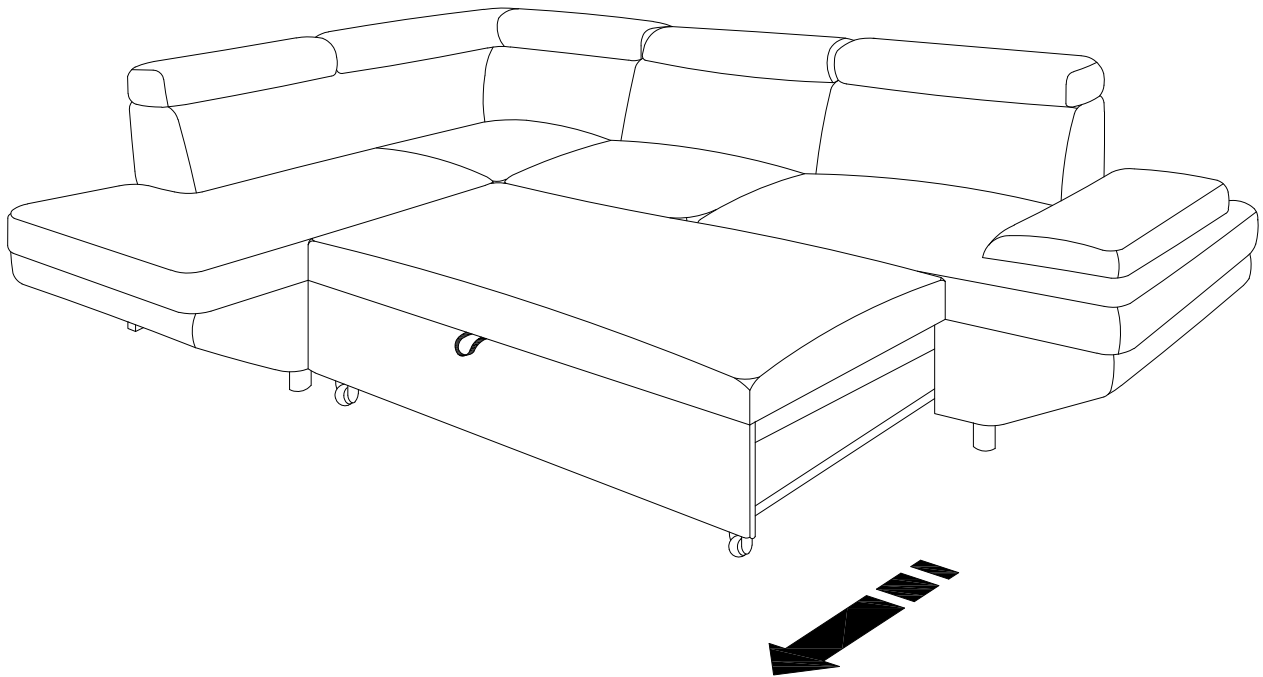

Allow Out