



1060 E. Springfield Rd.
High Point, NC 27283
(336)861-0003

ASSEMBLY INSTRUCTION

7820 - 913/977/330 BUNK BED ENDS

**BEFORE YOU START ASSEMBLING,
PLEASE MAKE SURE ALL PARTS & HARDWARE ARE INCLUDED IN BOX :**

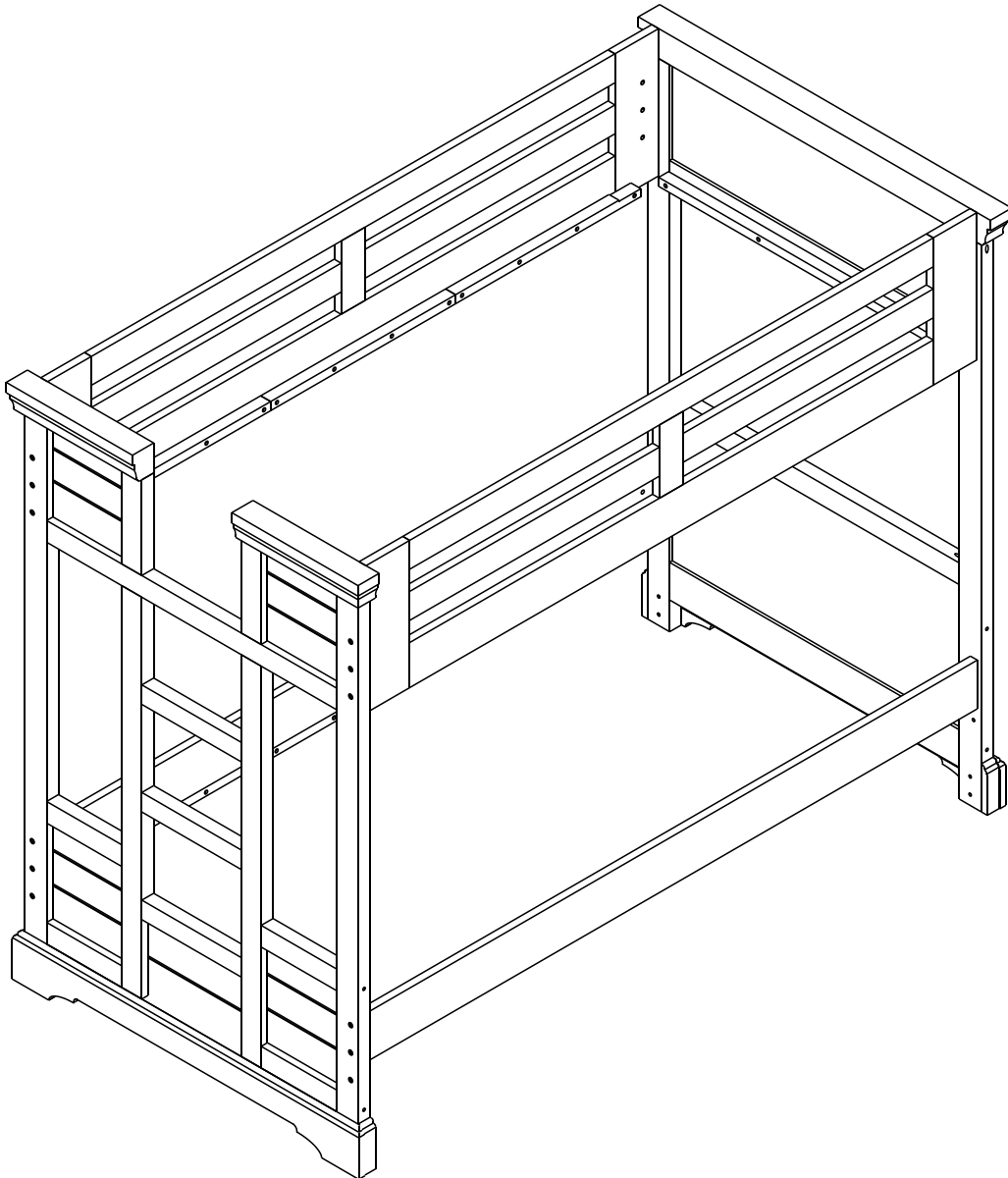

Thank you for purchasing furniture from American Woodcrafters. We are honored that you have chosen our furniture to compliment your home. Every effort has been made to ensure that your furniture is of the finest quality. If you find your furniture has a missing or damaged part, please contact the dealer from which you purchased this item, and they will be happy to assist you in any way they can. Thanks again for making American Woodcrafters a part of your home.



1060 E. Springfield Rd.
High Point, NC 27283
(336)861-0003

ASSEMBLY INSTRUCTION

7820 - 913/977/330 BUNK BED ENDS

BEFORE YOU START ASSEMBLING,
PLEASE MAKE SURE ALL PARTS & HARDWARE ARE INCLUDED IN BOX :

READ THESE INSTRUCTIONS CAREFULLY BEFORE ATTEMPTING TO ASSEMBLE THIS BED

1. Follow the information on the warning labels appearing on the upper bed end structure and on the carton. **Do not remove warning label from bed.**
2. Always use the recommended size mattress or mattress support, or both, to help prevent the likelihood of entrapment of rails. (See page 06)
3. Top surface of mattress must be at least 5 in. below the upper edge of guardrails. (See page 06)
4. **DO NOT** allow children under 6 years of age to use the upper bunk.
5. **PROHIBIT** more than one person on upper bunk.
6. Periodically check and ensure that the guardrails, ladder, and other components are in their proper position, free from damage and that all connectors are tight.
7. **DO NOT** allow horseplay on or under the bed and prohibit jumping on the bed.
8. Always use the ladder for entering and leaving the upper bunk.
9. **DO NOT** use substitute part. Contact manufacturer or dealer for replacement part.
10. Use of a night light may provide add bed safety precaution for a child using the upper bunk.
11. If the bunk bed will be placed next to a wall, the guardrail that runs the full length of the bed should be placed against the wall to prevent entrapment between the bed and the wall.
12. Always use guardrails on both long sides of the upper bunk.
13. The use of water or sleep flotation mattresses is prohibited.
14. Keep these instructions for future reference.
15. **STRANGULATION HAZARD** - Never attach or hang item to any part of the bunk bed that are not designed for use with the bed; for example, but not limited to, hooks, belts and jump ropes.
16. Max weight 175lbs on upper bunk.

Identifying the Part...

Use the illustrations below to correctly identify each of the parts of your bed

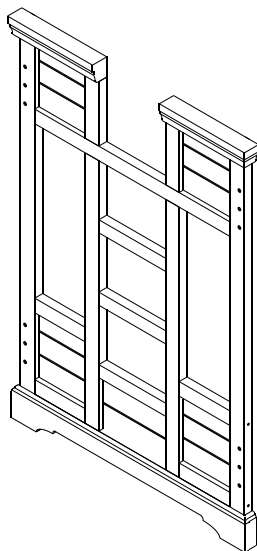

Carton 1
7820-913

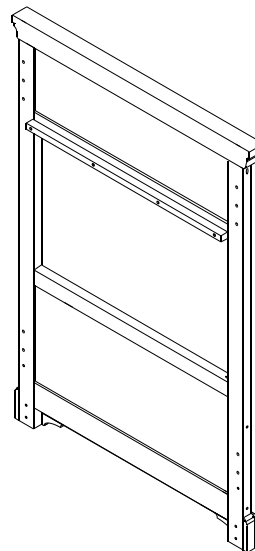



1060 E. Springfield Rd.
High Point, NC 27283
(336)861-0003

ASSEMBLY INSTRUCTION

7820 - 913/977/330 BUNK BED ENDS

BEFORE YOU START ASSEMBLING,
PLEASE MAKE SURE ALL PARTS & HARDWARE ARE INCLUDED IN BOX :

Carton 2 7820-977

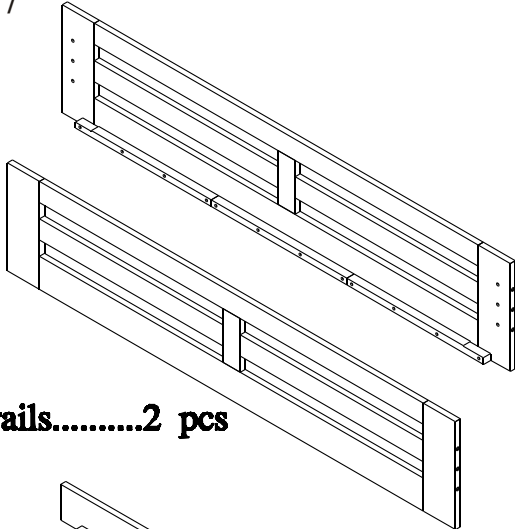

Guardrails.....2 pcs

Rails.....2 pcs

Carton 3 000-330

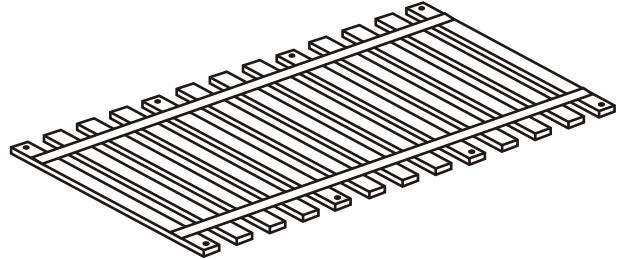

Slat.....13 pcs 3/3 Roll Slat

Carton 4 000-330

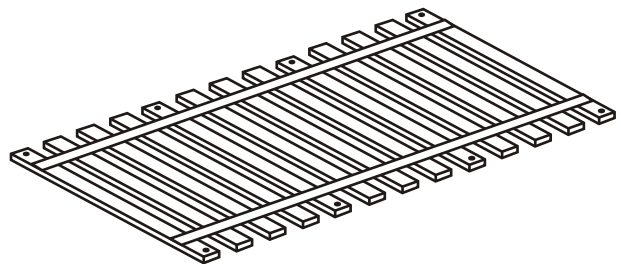



Slat.....13 pcs 3/3 Roll Slat

Identifying the Hardware....

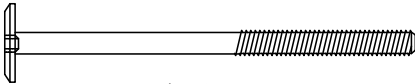
Identify the hardware using the illustrations bellow

| | | | |
|---------------------|---|--|-----------------------|
| ID # A |  |  | Quantity 20 |
| Long Bolt Connector | | | |

| | | |
|------------------|---|-----------------------|
| ID # B | Flat Washer  | Quantity 20 |
|------------------|---|-----------------------|

| | | |
|------------------|---|-----------------------|
| ID # C | Barrel-Nuts  | Quantity 20 |
|------------------|---|-----------------------|

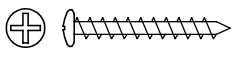
| | | |
|------------------|---|-----------------------|
| ID # D |  Medium Size Wood Screw | Quantity 16 |
|------------------|---|-----------------------|

| | | |
|------------------|--|----------------------|
| ID # E | 4 mm: Hex Key  | Quantity 1 |
|------------------|--|----------------------|

PHILLIP HEADSCREW DRIVER (NOT INCLUDE)





1080 E. Springfield Rd.
High Point, NC 27263
(336)861-0003

ASSEMBLY INSTRUCTION

7820 - 913/977/330 BUNK BED ENDS

BEFORE YOU START ASSEMBLING,
PLEASE MAKE SURE ALL PARTS & HARDWARE ARE INCLUDED IN BOX :

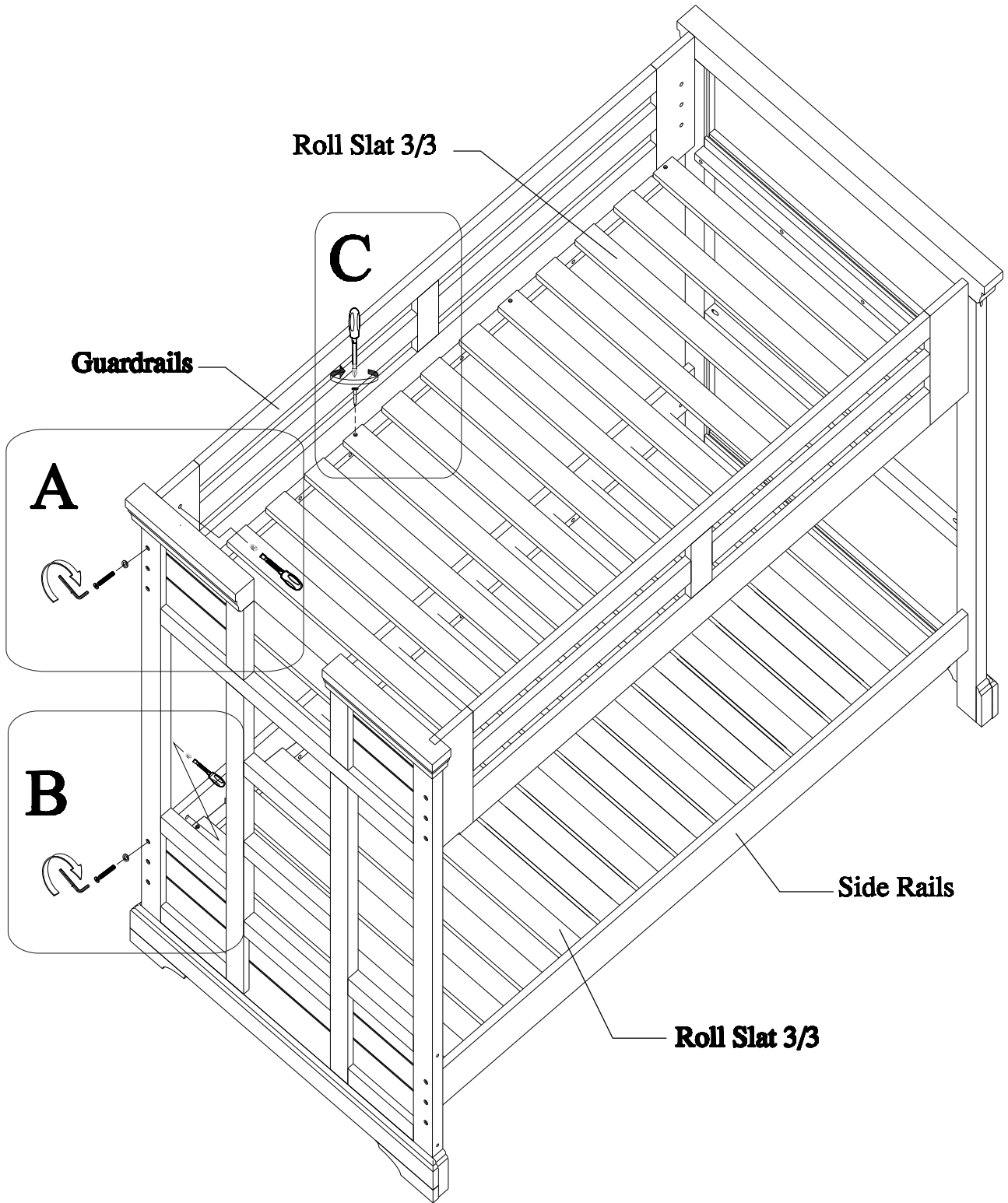



1060 E. Springfield Rd.
High Point, NC 27283
(336)861-0003



ASSEMBLY INSTRUCTION

7820 - 913/977/330 BUNK BED ENDS

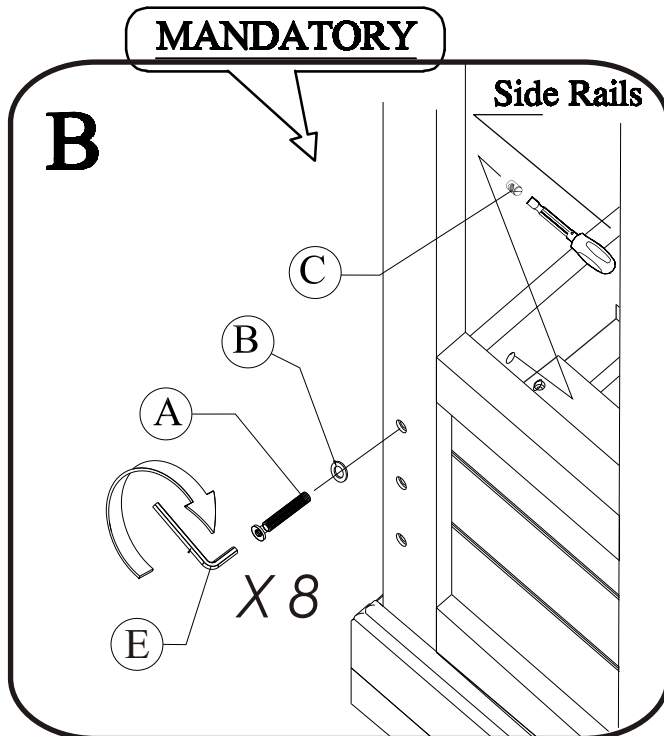
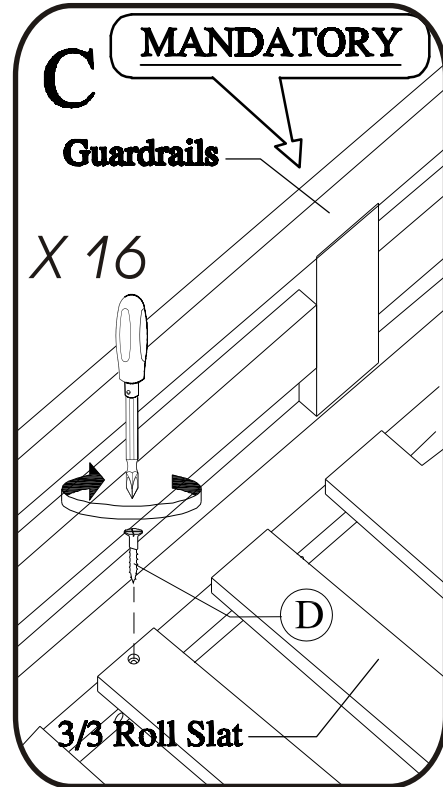
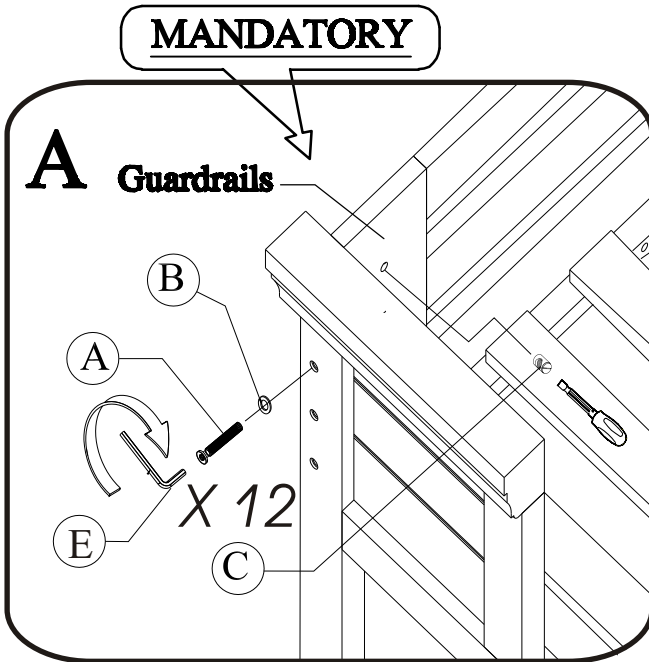
BEFORE YOU START ASSEMBLING,
PLEASE MAKE SURE ALL PARTS & HARDWARE ARE INCLUDED IN BOX :

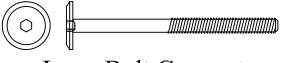

Hardware use in this step

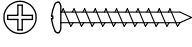
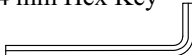
| ID # | | Quantity |
|------|--|----------|
| A |  Long Bolt Connector | 20 |
| B |  Flat Washer | 20 |
| C |  Barrel-Nuts | 20 |
| D |  Medium Size Wood Screw | 16 |
| E |  4 mm Hex Key | 1 |



1060 E. Springfield Rd.
High Point, NC 27263
(336)861-0003

ASSEMBLY INSTRUCTION

7820 - 913/977/330 BUNK BED ENDS

BEFORE YOU START ASSEMBLING,
PLEASE MAKE SURE ALL PARTS & HARDWARE ARE INCLUDED IN BOX :

UPPER BUNK MATTRESS DIAGRAM

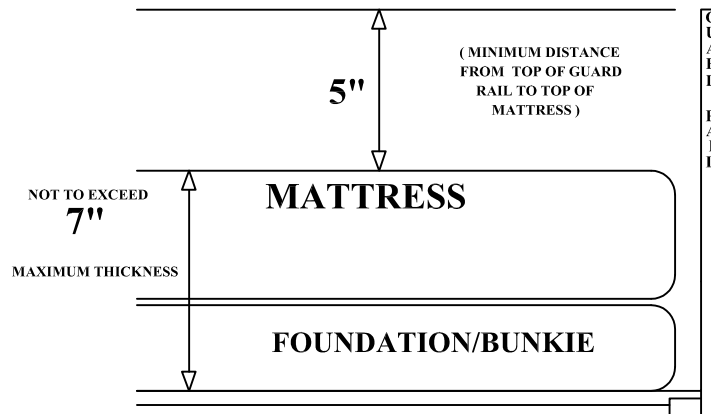

* Upper Bed Mattress Specifications:

Minimum Foundation & Mattress Size (37 1/2" x 74")
Maximum Foundation & Mattress Thickness Combined (7")

* Lower Bed Mattress Specifications:

Minimum Foundation & Mattress Size (37 1/2" x 74")
Maximum Foundation & Mattress Thickness Combined (7")

Replacement Part,
Including Additional Guard rails, may be obtained from any of our American Woodcrafters dealers.



1060 East Springfield Road
High Point, N.C. 27263
Phone: (336) 861-0003
Fax: (336) 861-0010

Thank you for purchasing our product, we hope it brings you years of enjoyment.