

Pool Fence Installation Guide



✉ VIWATCustomerService@gmail.com

Our team is available 24/7 to help with any product questions. Contact us anytime!

POOL FENCE INSTALLATION GUIDE

INDEX

Getting Started

Section 1: Layout and Marking Out your Deck

Section 2: Understanding How to Drill

Section 3: Drilling and Inserting Ground Sleeves

Section 4: Making Your Custom Cut

Section 5: Finishing and Latching your New Pool Fence

TOOLS REQUIRED

1. Hammer Drill
2. 1-1/8" Masonry
3. Extension Cord
4. Tape Measure
5. Hammer
6. Marker
7. Garden Hose
8. Scissors
9. Household Stapler
10. #2 Square Head Screw Tip
11. 1/8" Metal Drill Bit
12. Cordless Screw Gun
13. 1-Template(Incl.)
14. Chalk Line

Each Fence Section Includes: 1 Mark Out Template, 1 latch, 6 Ground Sleeves, 6 Ground Caps

NOTE: Fence sections are 180" of pool fence mesh bordered on all five sides with 6 fence posts spaced every 36".



REMEMBER: Nothing replaces direct adult supervision. Never leave a child unattended. (Read Instructions Completely Before Beginning)

STEP 1: LAYOUT & MARK-OUT

*Layout: The fence should be a minimum 36" off the pool edge. **See Fig. 1 & Fig. 2**

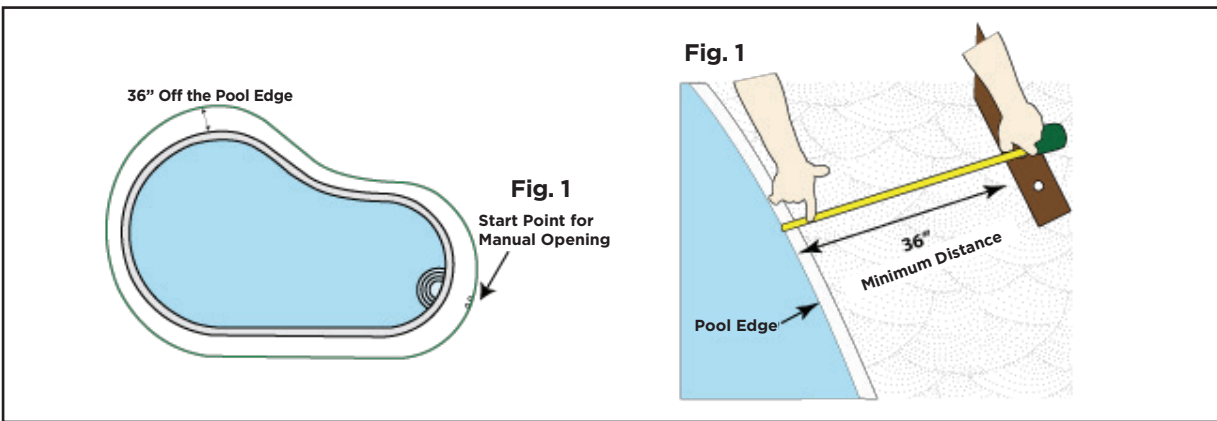

*Start Point: Is the manual opening to enter the pool area. See **Fig. 1** Use the double hole on the section template provided and mark your first hole 1L **Fig. 3**. 1L is for the 1st pole of the full section going to the left side of the pool.

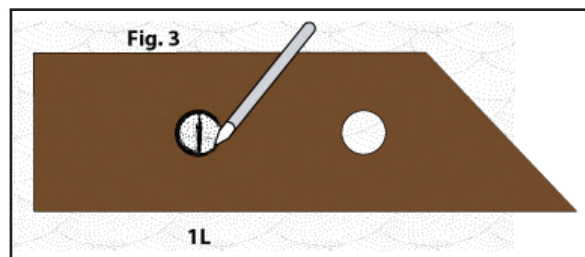

*Now place the template over the mark 1L that you just marked and mark your next hole, 1R **Fig. 4** 1R is for the 1st pole of the full section going to the right side of the pool.

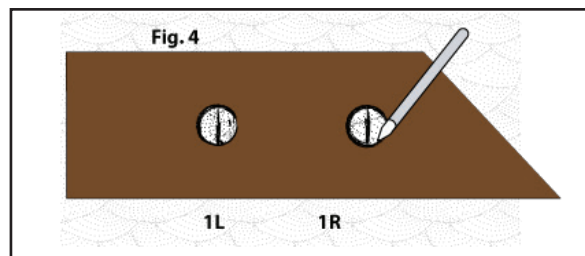

MARK OUT:

*Once both holes of the start point are marked, (1L & 1R) place the template provided over 1R **Fig. 5**.

*Then place the template over 1R and mark your second hole for that section (**Fig. 5a**)

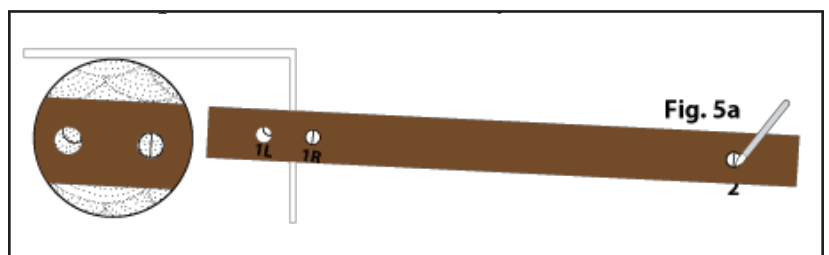
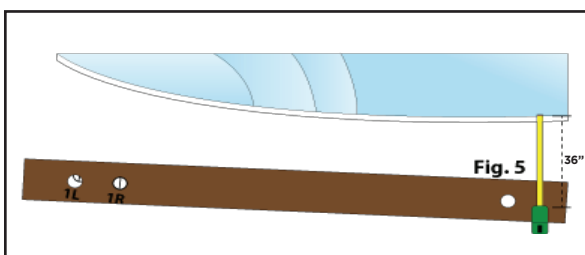

*Now repeat until pole 5th of the section **Fig. 6-7a**

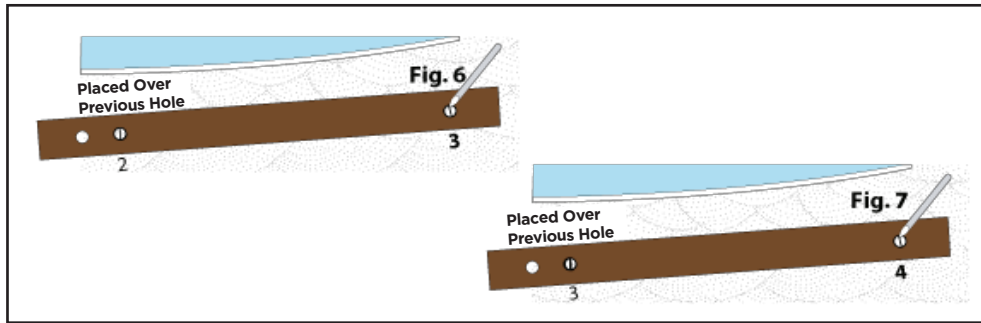

*Mark your last hole for that section, (hole 5) **Fig. 7a.**

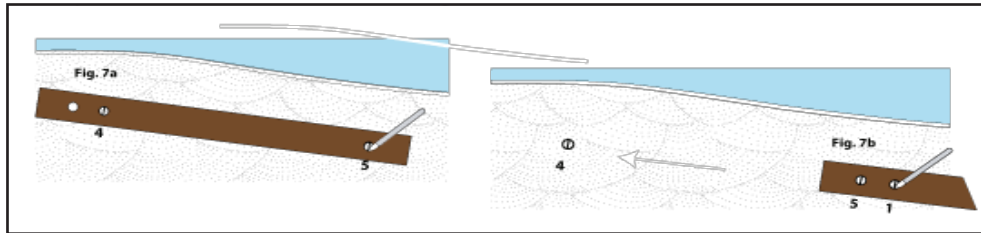

*Then use the double hole on the template and align it over the 5th hole you marked **Fig. 7b** and mark the first hole of the next connecting section to the right,(hole). Repeat these steps on the both sides of the pool until you reach the section that will be the cut section.

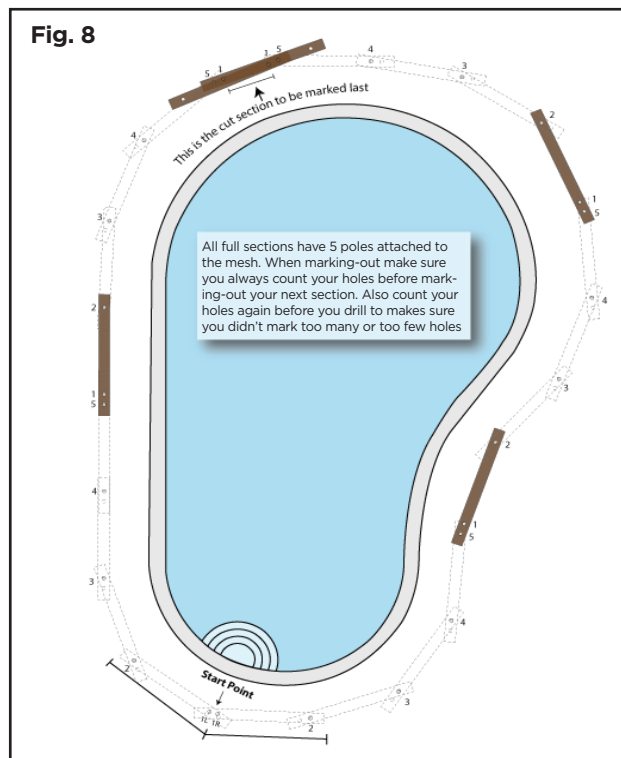

*Custom Cut: Is when the last piece is less than the 36" template, Marking your custom cut is just like marking out a full 36" panel is usually shorter than 36". This is the custom cut you will make later. This section is the last one marked out, usually in the back of the pool, when you will not notice it. The last piece will most likely have fewer poles in it. This example depicts a two pole cut.

*Lay back Holes are needed for the manual opening and are used to place the end poles of section into when using the pol. See **Fig. 9 & 10**

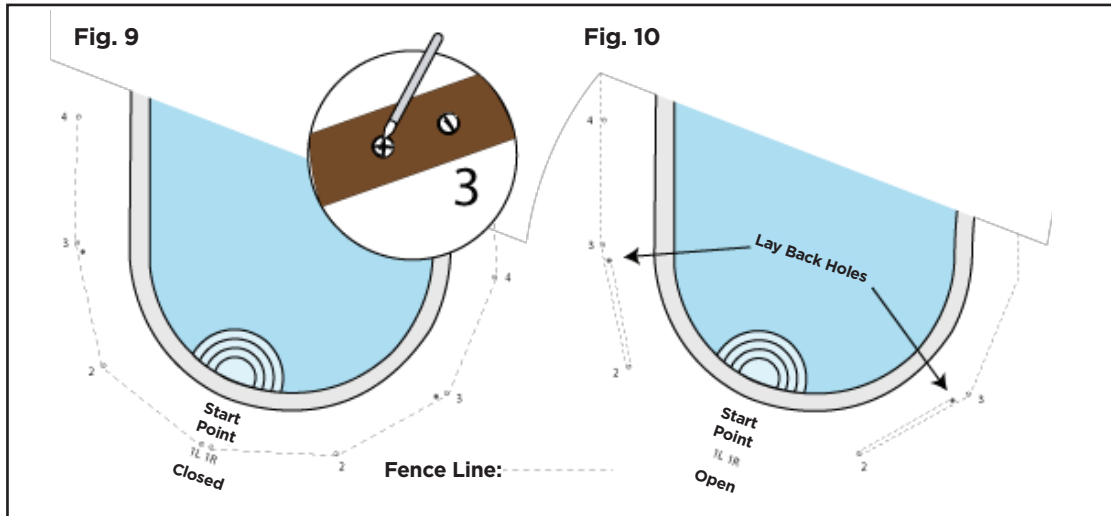

STEP 2: UNDERSTANDING HOW TO DRILL

*Angle & Level Hole: Before drilling you need to survey all the holes and mark the direction in which the holes will be drilled, should it be a Light Lean Angle, Heavy Lean Angle or a Level Hole? Should the pole lean toward the pool or away from the pool or be level? See diagram below. Mark an arrow on the deck surface to avoid making a mistake. Angles are needed to ensure proper tension and aesthetics. **Fig. 12** show a Light Lean Away from the pool. **Fig. 13** shows a Heavy Lean toward the pool. Level holes are drilled perpendicular to the deck surface or no lean at all. See **Fig. 14**

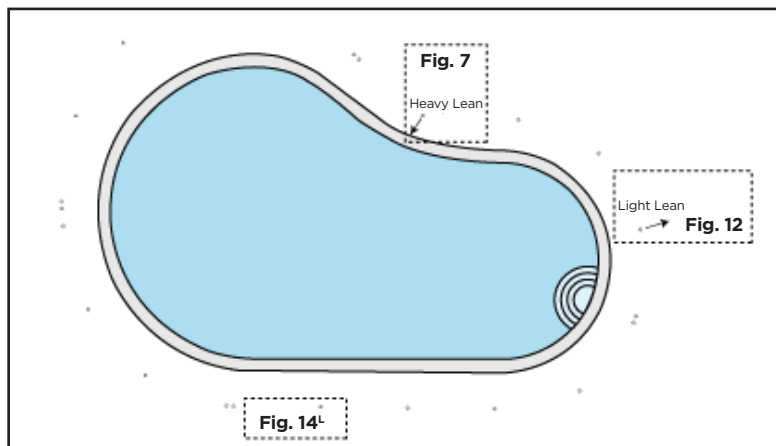

*Understand the Angle to be Frilled: See **Fig. 15a-Fig. 17**

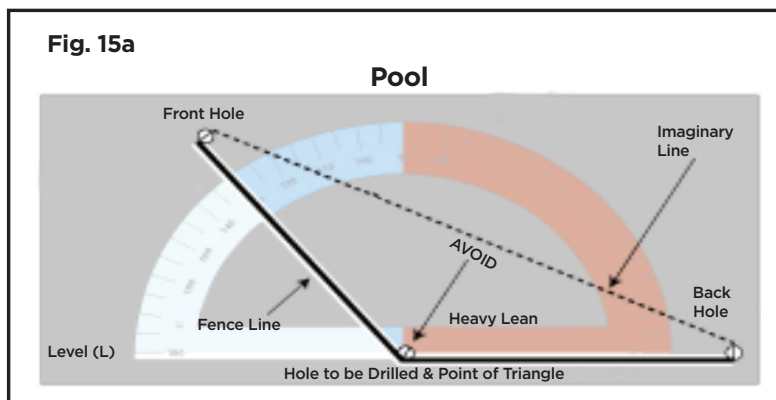

PRO NOTES: Any hole to be drilled will have a hole in front of it and one in the back of it as shown in **Fig. 15a**. If the hole to be drilled is in the heavy range it will require a Heavy Lean. If the hole to be drilled is in the light lean range, it will require a Light Lean. See **Fig. 15b**.

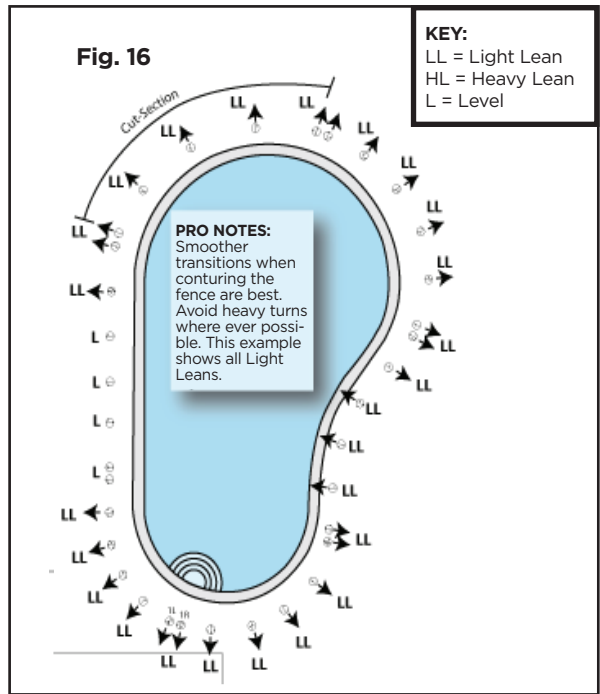
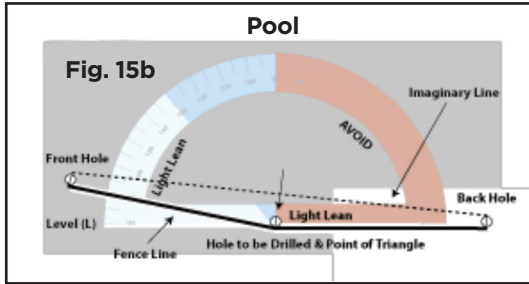

NOTE: Stabilize drill guide with foot pressure to prevent drill guide from shifting. *Sleeving: Once drilling is complete flush out the debris from the holes using a garden hose **Fig.19**. Next insert the plastic sleeves in the holes and tap down completely **Fig.20**.

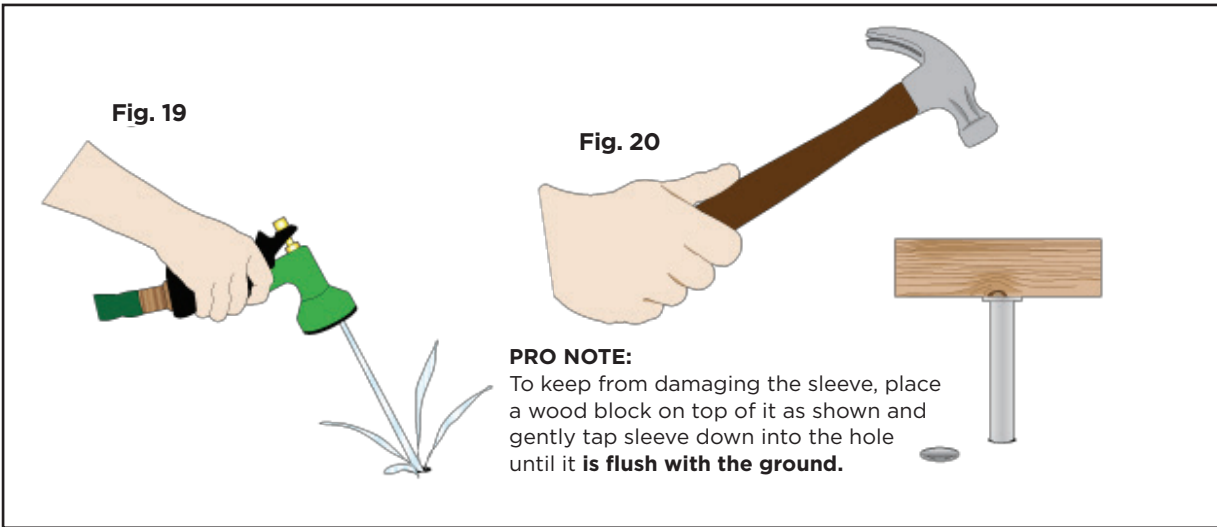

Installing Sections: Start at a double hole (where sections connect) and put your first pole in. You should always lean the pole you are leading with back as shown below in **Fig.20** to get it started in the hole. Then push the pole forward along the line of fence and down into the hole until the bottom of the fence is flush with the deck sleeve. Repeat this until all your sections are installed.

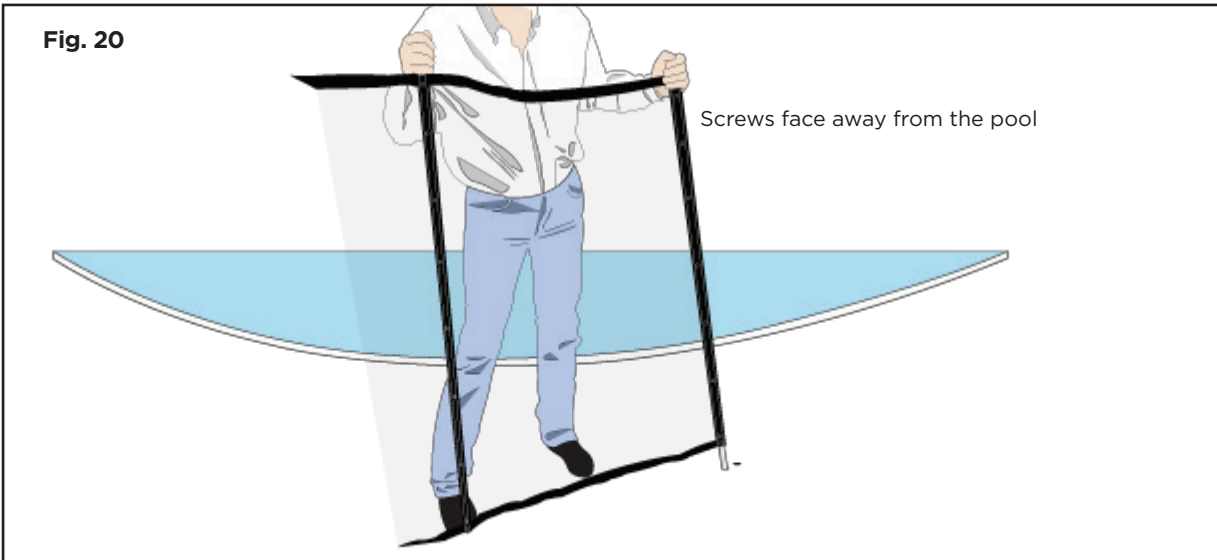

STEP 4: MAKING YOUR CUSTOM CUT

*Measuring Your Custom Cut: Your custom section is the one that doesn't fit. The first step is to measure your custom cut. Note whether you will be cutting from the right side or the left side of the full section. See **Fig.21** below

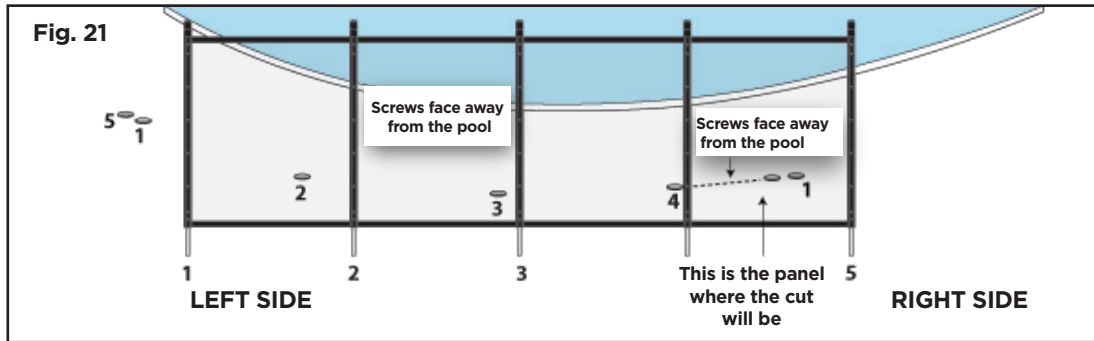

PRO NOTE: When measuring for a custom cut or cutting fence you should always remember that the moldings face out away from the pool. When measuring your cut section always face the pool. Measure the outside centerline of the odd panel. Next count the number of poles in the odd section and double check whether it is a cut to the right or a cut to the left. See **Fig. 22-23**.

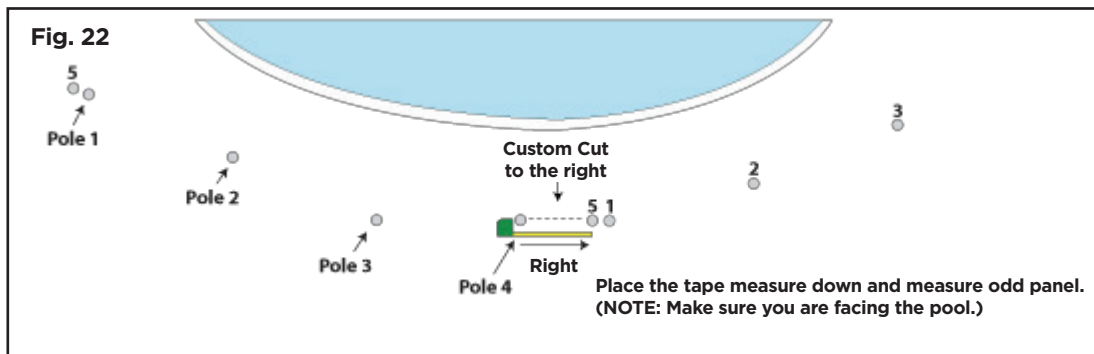

If you noticed in **Fig. 22** our example custom cut is a 4 pole and then a cut to the right. Let's say this cut is a 4 pole 23 1/2" to the right. When you measure make sure you are measuring between the two centerlines of either hole. **Fig. 23** illustrates the scribe lines but when you are ready to measure for your cut you will be dealing with drill holes in the concrete and there will be no scribe lines draw across the holes. The scribe lines in the figure are to remind you that your cut happens to fall on a turn, you must remember that your center line turns as well.

***Make Your Cut:** Now you have the measurement and you can make the cut. Roll out your full section(screws facing up) in front of the custom cut area and face the pool. Looking at the full section count the poles over until you reach the panel that needs to be cut. Our example cut is a 4 pole 23 1/2" to the right. See **Fig.24** below

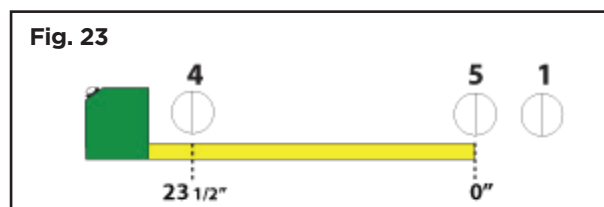

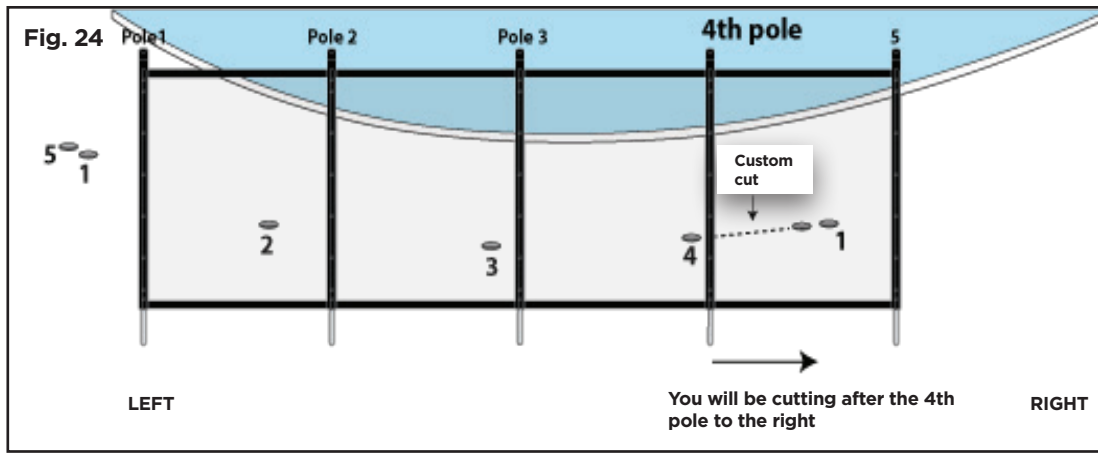

Hold your tape measure on the **OUTSIDE THE MOLDING** as shown un **Fig.25**. and make a mark on the border at the top and bottom of the fence with a marker.

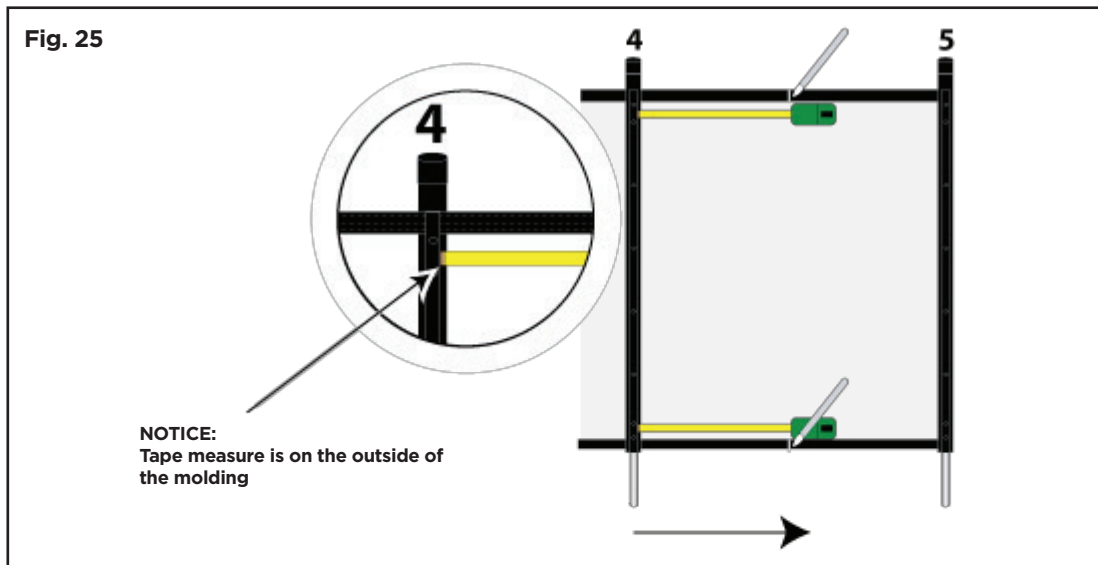

Using your scissord you can proceed to cut the mesh. Sliding your ruler up against the molding to make sure you are cutting at exactly the measurement you took. See **Fig. 26** Make sure the mesh is tight and remove the extra pole from the extra piece.

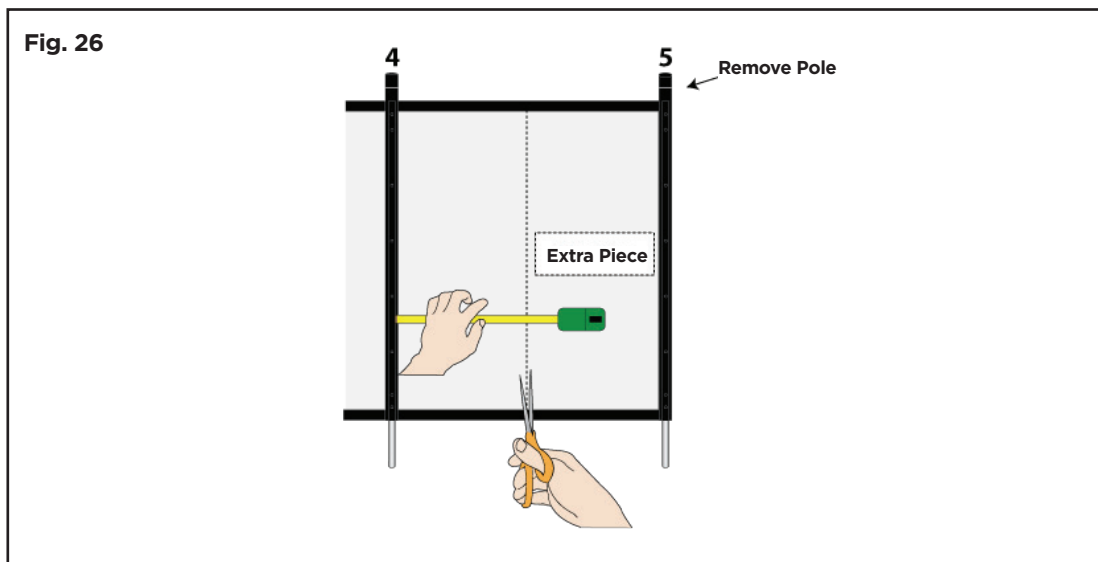

Now your border has been attached to the cut side of the mesh. Cut of excess border. Your next step is to attach the pole you removed in **Fig. 26** to the cut side. The best way to attach your pole to the cut is as follow:

- Lay your molding strip on top of the border you just attached. **Fig. 29**
- Line up molding so that it's flush with bottom & flush with line of mesh. Make sure all staples are covered by molding **Fig. 29**
- Screw one screw into the molding at the top until it comes completely through the molding mesh and border
- Then put one screw into the molding at the bottom until it comes through to the side of the molding and mesh. Your molding should now be attached with 2 screws to the cut piece of the fence.
- Slide your pole underneath the molding & mesh, and align the screws that came through the otherside to the corresponding holes of the pole. Partially back out your top screw while keeping pressure on the molding and the pole to keep it from moving. Then slowly drive the screw back down into the pole. Repeat this step for the bottom screw . See **Fig. 30**
- Finally place the rest of the screw into the pole and slowly screw them down. Your end pole is now attached.

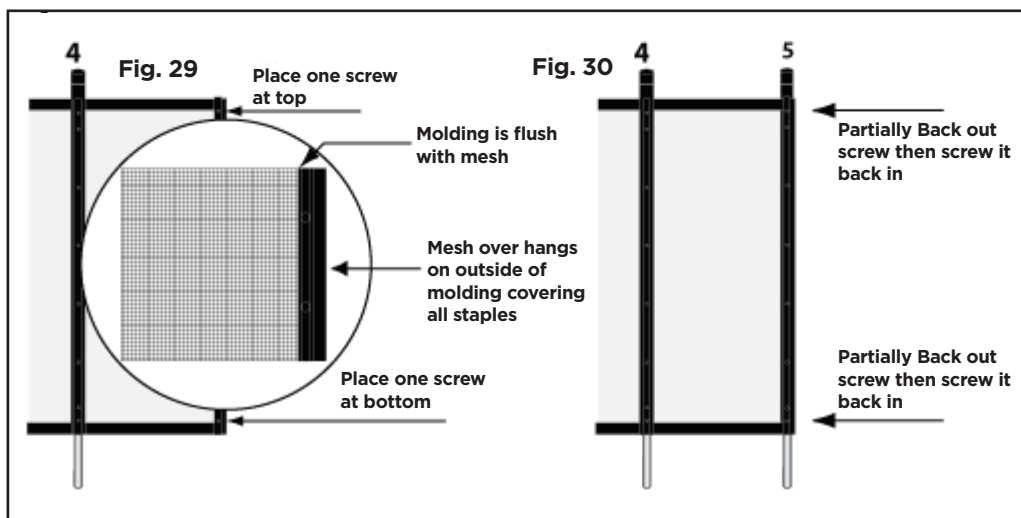

STEP 5: FINISHING & LATCHING YOUR NEW POOL FENCE

- Latching the fence: You now have all the full sections installed and the custom cut made as well. Each full section has a pilot hole at the top between the first and second screw. Follow these steps to ensure your fence is latched properly.
- Using your 1/8" drill bit, carefully drill out the pilot hole and slightly bevel the hole. **Fig. 31**
- Screw one screw eye into each hole on opposing sections. **Fig. 32**
- Squeeze the poles and clip the double hasp latch on to either screw eye. **Fig. 33**
- Follow these steps for each section connection.

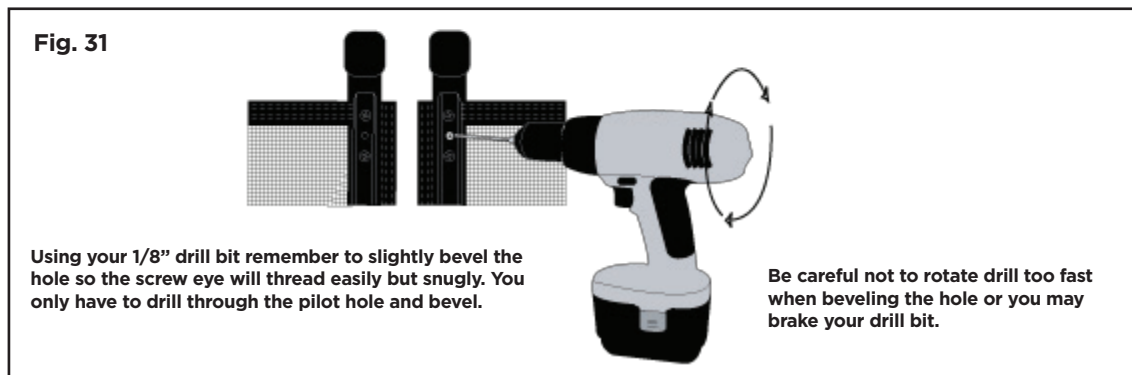

Put the removable screw eye in first, as shown to the right in **Fig. 32**. Use the latch for leverage. Then disconnect the latch from the screw eye and turn the other screw eye in using the latch for leverage. Make sure both screw eyes are tightened until there are no visible threads.

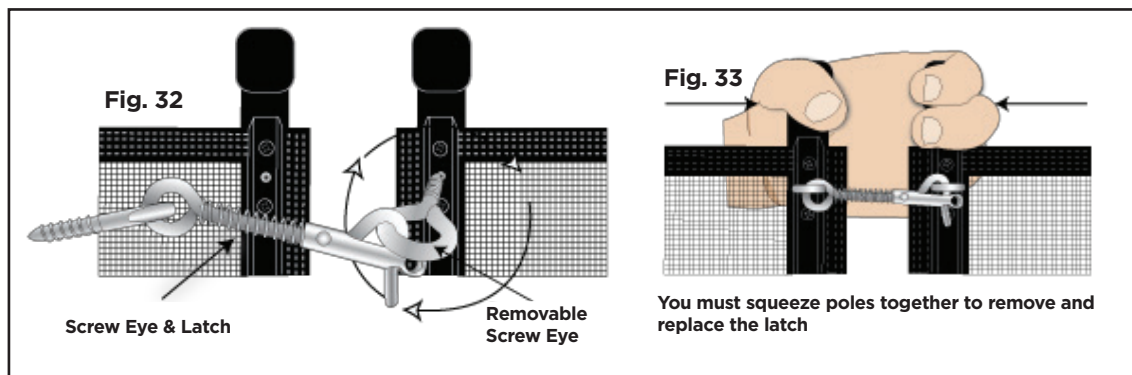

The fence works on tension so you must squeeze the poles together in order to connect the latch to the screw eye. (TIP) Before you squeeze the poles together make sure that the poles are straight. The tension of the fence will want to twist the poles away from each other. Once you have twisted the poles as straight as you can, grab one pole and lock it between your thumb and palm by squeezing it tightly. This will help prevent the poles from twisting away from each other when you squeeze them to connect the latch.

Congratulations! You have just installed your new Pool Fence

- Keep gates and manual openings closed at all times.
- Periodically check fence for proper function.
- The Fence must block all entrances to the pool area.
- Keep fence away from staging platforms ie: tables or chairs.
- Leave room between fence & pool to allow for a walkway while fence is up.
- If fence is terminating to an existing structure make sure the structure is solid enough and the latch can not pull out allowing a child to get through.
- Removable mesh safety fence is not intended to be a substitute for proper adult supervision and is not a guarantee against access to the pool.
- Children should always be carefully watched at all times.
- Layers of protection such as a fence, pool alarm, door alarm, swimming instruction, personal immersion alarms, and proper adult supervision in and around your pool can help reduce unauthorized access.
- If you are installing the fence to meet with code requirement check your local building codes to be sure you are in compliance with local fencing laws.