

ASSEMBLY INSTRUCTIONS

FULL BED

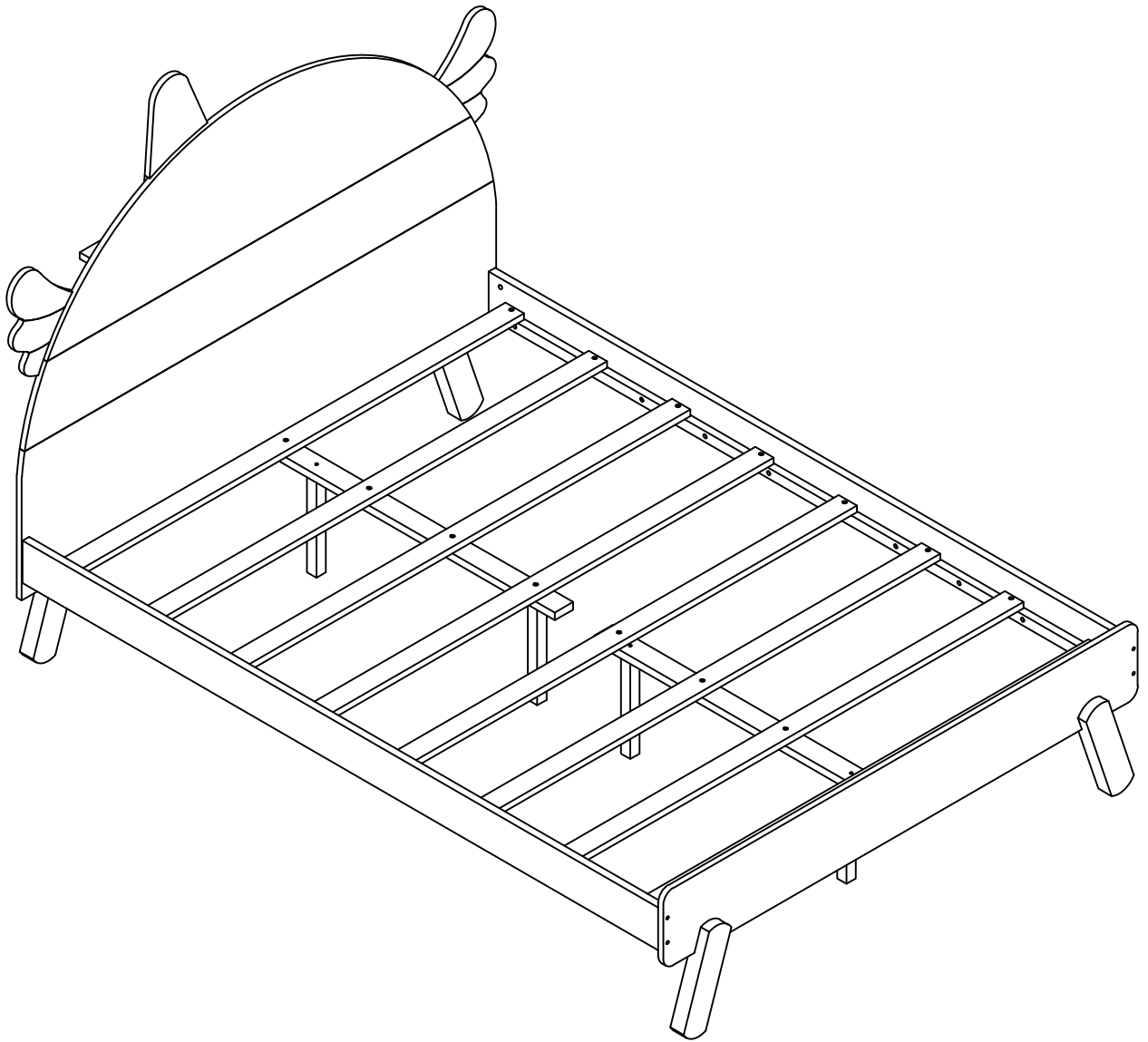





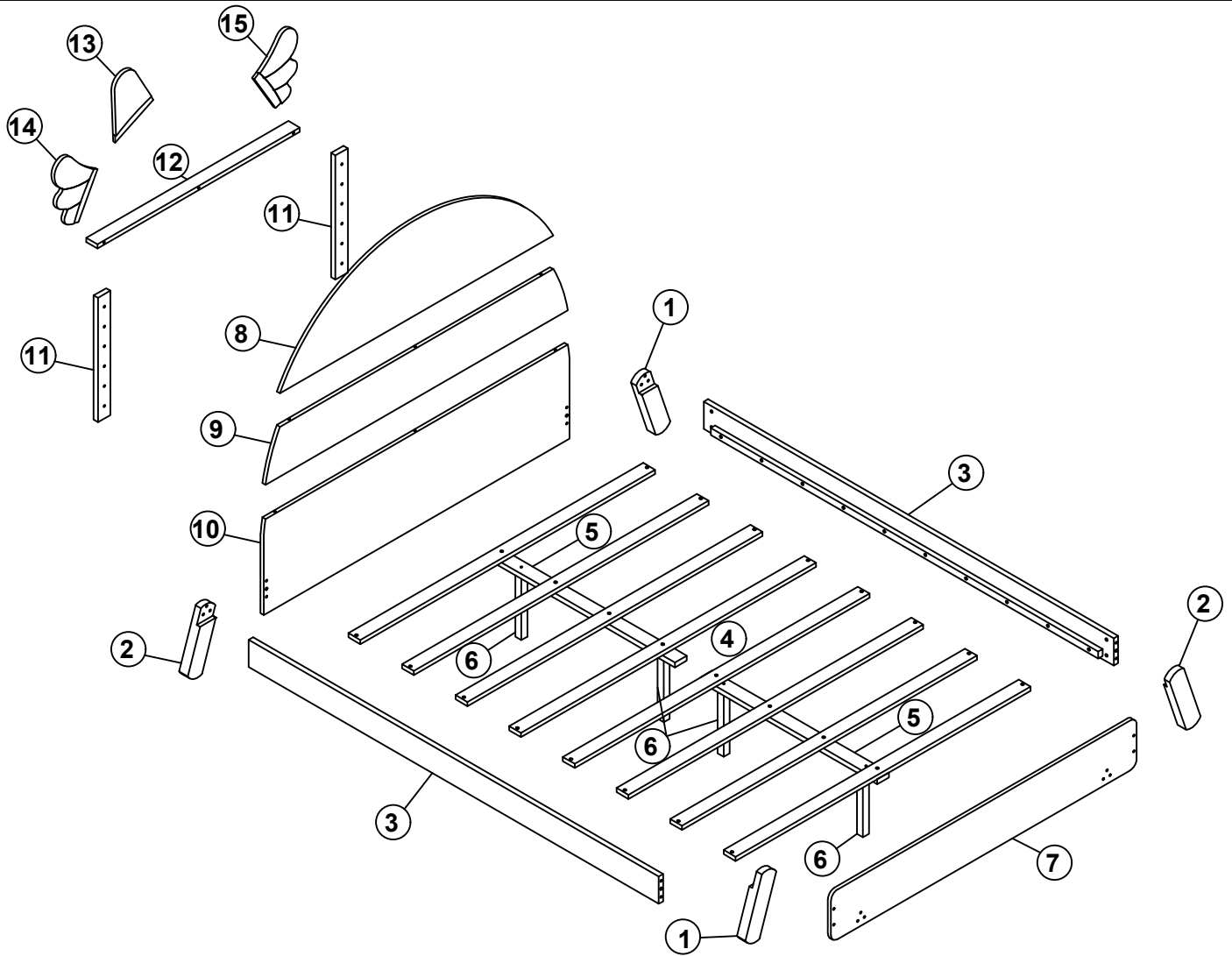







WF295687AAH

ASSEMBLY INSTRUCTIONS

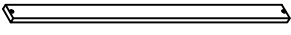
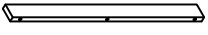
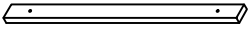











PARTS LIST

WF295687AAH

1	Left front & right back legs 	2pcs	9	Headboard panel 	1pc
2	Right front & left back legs 	2pcs	10	Headboard panel 	1pc
3	Side rails 	2pcs	11	Headboard support panels 	2pcs
4	Slats 	8pcs	12	Headboard support panel 	1pc
5	Center rails 	2pcs	13	Hat panel 	1pc
6	Center rails support legs 	4pcs	14	Left wing panel 	1pc
7	Headboard panel 	1pc	15	Right wing panel 	1pc
8	Headboard panel 	1pc			

ASSEMBLY INSTRUCTIONS

HARDWARE LIST (WF295687AAH)

A	Ø4x30		24PCS	F	Ø8x30		6PCS
B	1/4x65		8PCS	G	6.5x50		4PCS
C	1/4x60		3PCS	H	1/4x25		4PCS
D	1/4x30		24PCS	J	4x58		1PC
E	Ø10x30		4PCS	K	Ø4x20		9PCS

Step 1

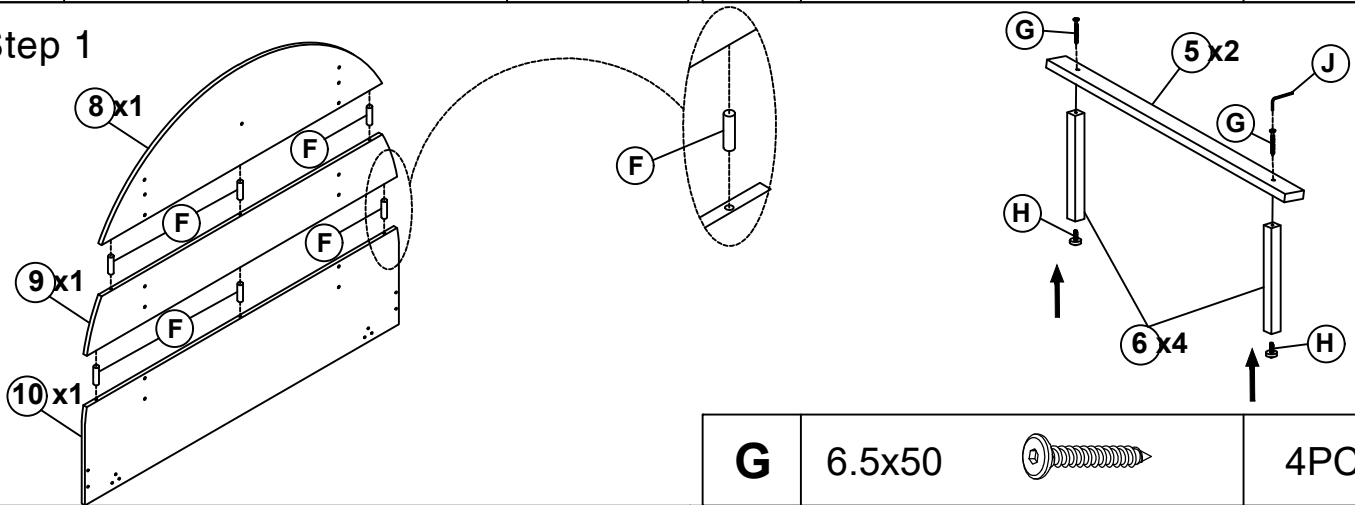

G	6.5x50		4PCS
----------	--------	---	------

H	1/4x25		4PCS
----------	--------	---	------

F	Ø8x30		6PCS
----------	-------	---	------

Step 2

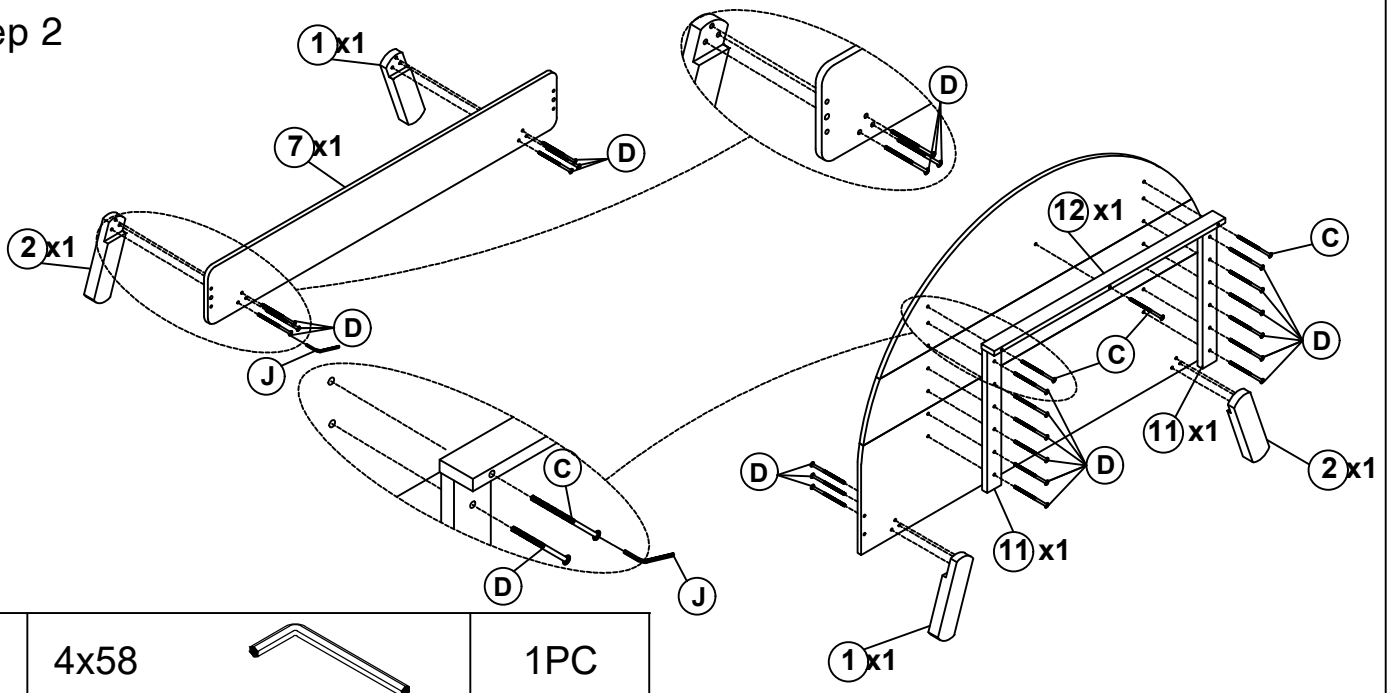

J	4x58		1PC
----------	------	---	-----



D	1/4x30		24PCS
----------	--------	---	-------

C	1/4x60		3PCS
----------	--------	---	------

ASSEMBLY INSTRUCTIONS

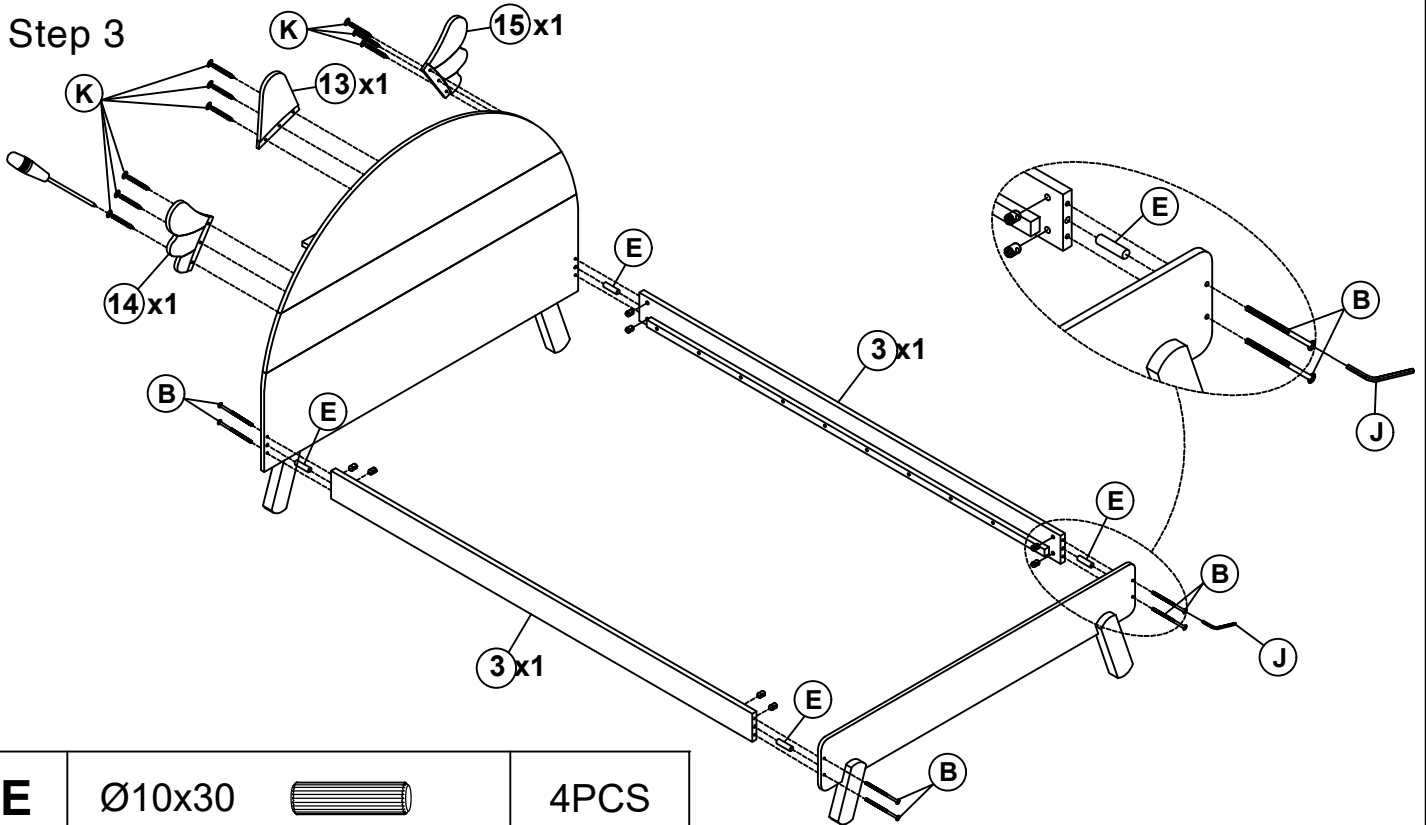
Step 3



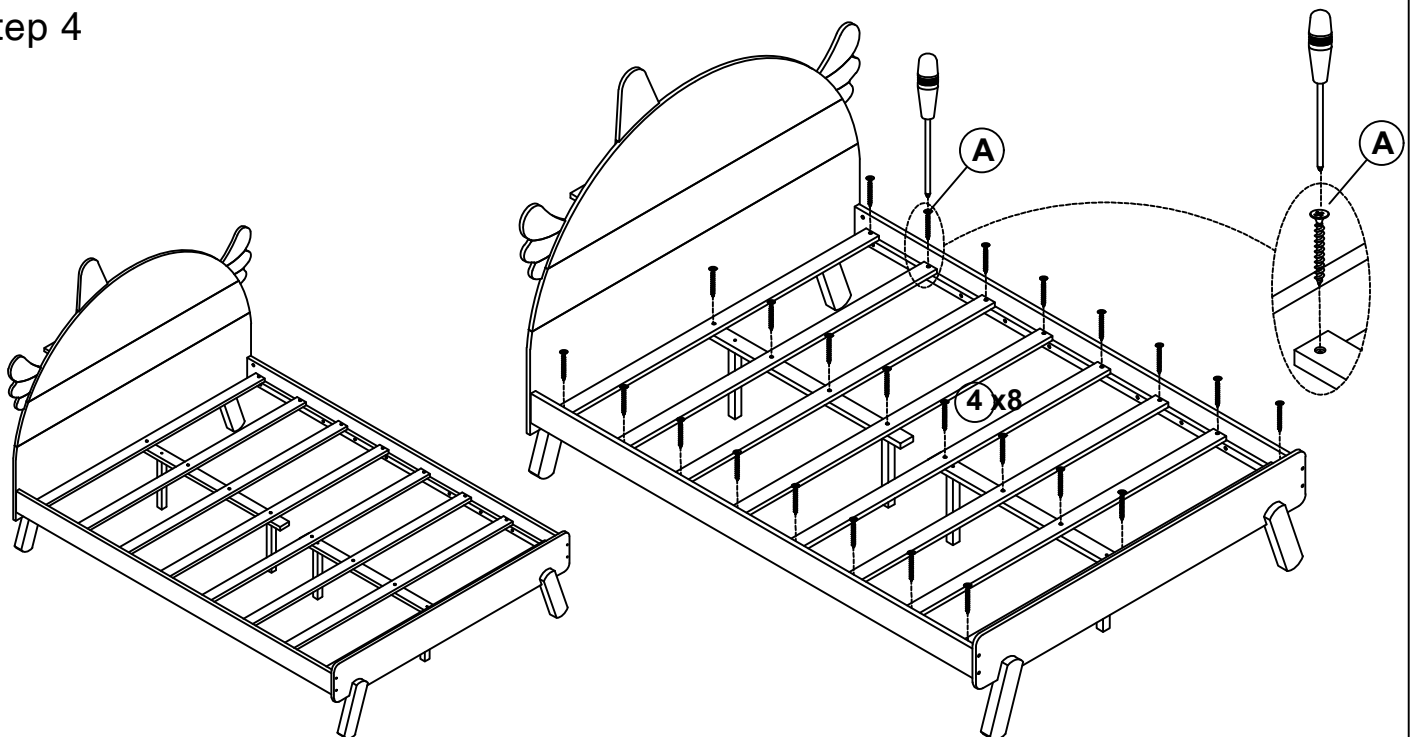

E	Ø10x30		4PCS				
B	1/4x65		8PCS	K	Ø4x20		9PCS

Step 4

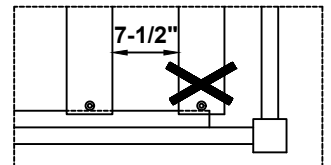
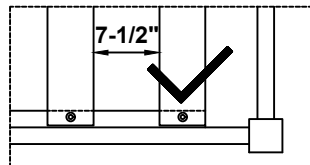

First attach 2pcs part 4 to the front and end of the frame between headboard.
Then attach the remaining part 4 equidistantly between headboard



A	Ø4x30		24PCS
----------	-------	---	-------