

# **DACKDOWN SECTIONAL -SIDE SEAT**

## **Assembly Instruction**

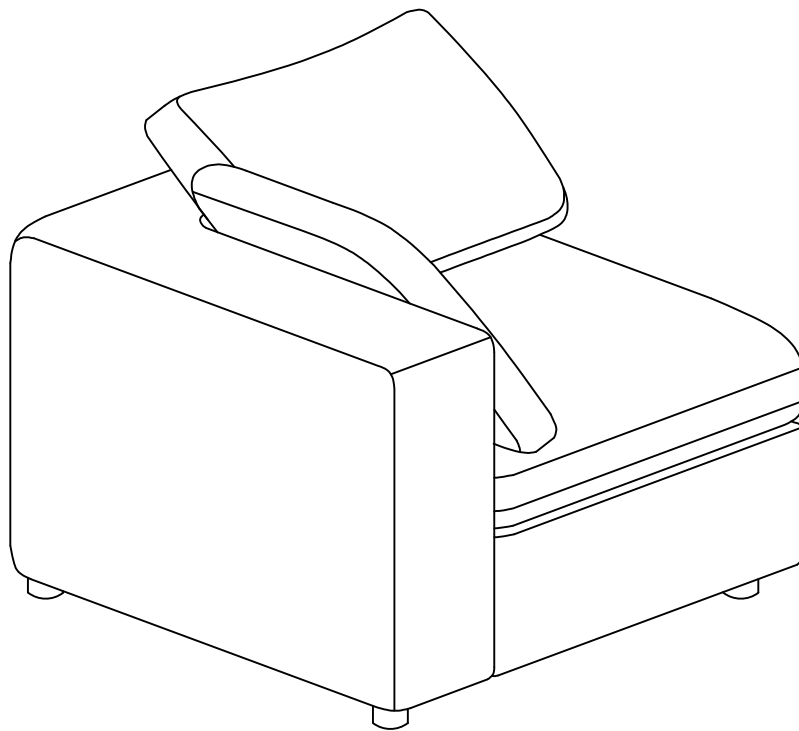

Any question please feel free to contact us:  
[support@merluxyhome.com](mailto:support@merluxyhome.com) TEL:901-347-2181  
We will provide further assistance within 24 hours.

### **Dear customers,**

Thank you for purchasing our product. Please read this instruction manual carefully after receiving this product. It will help you assemble this product quickly, safely, and correctly. You can keep this manual for future reference.

## Seller's Notice:







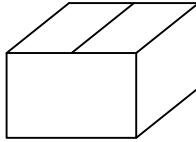











Our product is packed in separate boxes as shown below, and they might be shipped in different batches. Please wait until you received all the boxes .



















The following is the list of components contained in each box.

## BOX4



### Chair

		Seat Frame	<b>x1</b>
		Side Bezel	<b>x1</b>
		Armrest	<b>x1</b>
		Back Frame	<b>x1</b>
		Slipcover	<b>x1</b>
		Seat Pad Cover	<b>x1</b>
		Seat Foam	<b>x1</b>
		Back Cushion Cover	<b>x2</b>
		Back Cushion	<b>x2</b>

		6*18mm Washer	<b>x28</b>
		6*20mm Bolts	<b>x14</b>
		6*30mm Bolts	<b>x10</b>
		6*40mm Bolts	<b>x4</b>
		M4 Allen Key	<b>x1</b>
		4*4*18cm Connector	<b>x4</b>
		4*6*6cm Connector	<b>x6</b>
		H4 Wrench	<b>x1</b>
		Sofa Leg	<b>x4</b>

# Safety and care advice

## Important-Please read these instructions fully before starting assembly

Thanks for your purchase. Before the assembly please follow the instructions to check if all the spare parts and screws are intact.

- Considering the size and weight of the sofa, we recommend two adults to assemble the sofa, on a carpeted or padded area, in the room that it is intended for. Approximate assembly time: 30 minutes.
- Please do not throw away any of the packaging or the instruction until you have checked all the components and hardware and the furniture is fully assembled. Please ensure that the packaging is disposed in a safe and environmentally friendly way.
- Keep all components and packaging out of reach of children or animals to avoid the risk of choking or suffocation.
- Please do not take off the cover, and do not wash.

Your cushions come vacuum packed and sealed for shipping. To restore the cushion's original shape, follow the steps below.

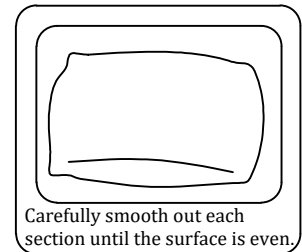
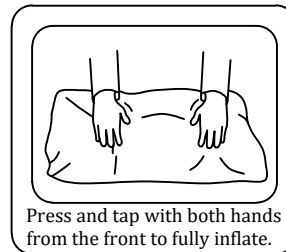
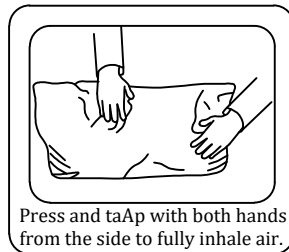
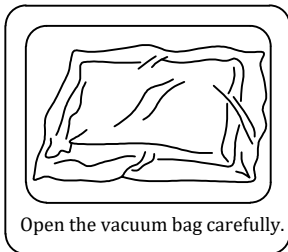

After packing up, place them in somewhere dry and ventilated. After about 72-96 hours. It can be restored to the best use condition.

# Customer service

## Important-Please read these instructions fully before starting assembly

If you encounter any issues upon receiving your package, such as missing accessories, damaged packaging, or product defects, please don't worry. You can follow the steps below to contact us for assistance.

### Missing Accessories

- **Missing Accessories**

**Accessory Check:** Please carefully check the accessory list included with the product (the accessory list can be found on [] of the user manual) to verify the missing accessory's name, specifications, and quantity. To help us better understand the issue and arrange for the missing accessories to be sent to you as soon as possible, please provide clear images of the missing accessories. Example as follows::

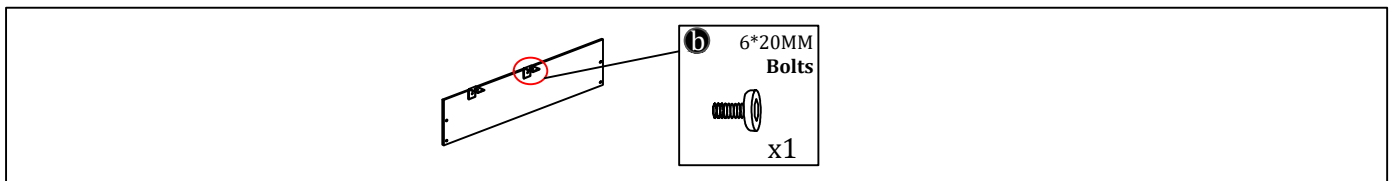

**Contacting After-Sales Service:** Once you've verified the missing accessories and prepared the images, you can contact our after-sales team via the following convenient methods:

**Phone:** Call our after-sales hotline at [\*\*\*\*\*] during working hours ([\*\*\*\*\*]). Our professional customer service team will promptly assist you and record the details of your issue. Please accurately describe the details of the missing accessories

along with your order information (such as order number, purchase platform, purchase date, and other key details, which will help us quickly search, record and efficiently resolve your issue)

**Email:** You can also send an email to our after-sales service at [\*\*\*\*\*]. Please include "Missing Accessories Feedback" in the subject line, and in the body of the email, clearly list the details of the missing accessories along with the images and your order information. Our after-sales team will review your email as soon as it is received and arrange for the reshipment of the missing items.

- **Severe Damage (Affects Usage):**

If the product or packaging is severely damaged and this affects the normal use of the product, please take clear photos or videos that show the damaged area(s) and the extent of the damage (we suggest taking photos from multiple angles to fully capture the issue). Please send these to our designated after-sales service email at [具体邮箱地址] with the subject line "Product Damage Affects Usage Feedback." Include your order information in the body of the email. Once we confirm the issue, we will promptly arrange a replacement or process a refund according to your preference, ensuring that your rights are protected.

- **Minor Damage (Does Not Affect Usage):**

If you assess that the damage to the product or packaging does not significantly impact the normal use of the bed fram, you can still contact our after-sales team (phone: [\*\*\*\*] or email: [\*\*\*\*]) to report the damage and provide relevant images or videos(The same procedure as above). We will either provide professional repair guidance to help you fix the issue yourself. Alternatively, depending on the extent of the damage, we may offer partial compensation as an apology to ensure you are satisfied with the use of our product. Regardless of the situation you encounter, our after-sales team will approach it with professionalism and responsibility, actively working to resolve the issue and safeguard your shopping experience.





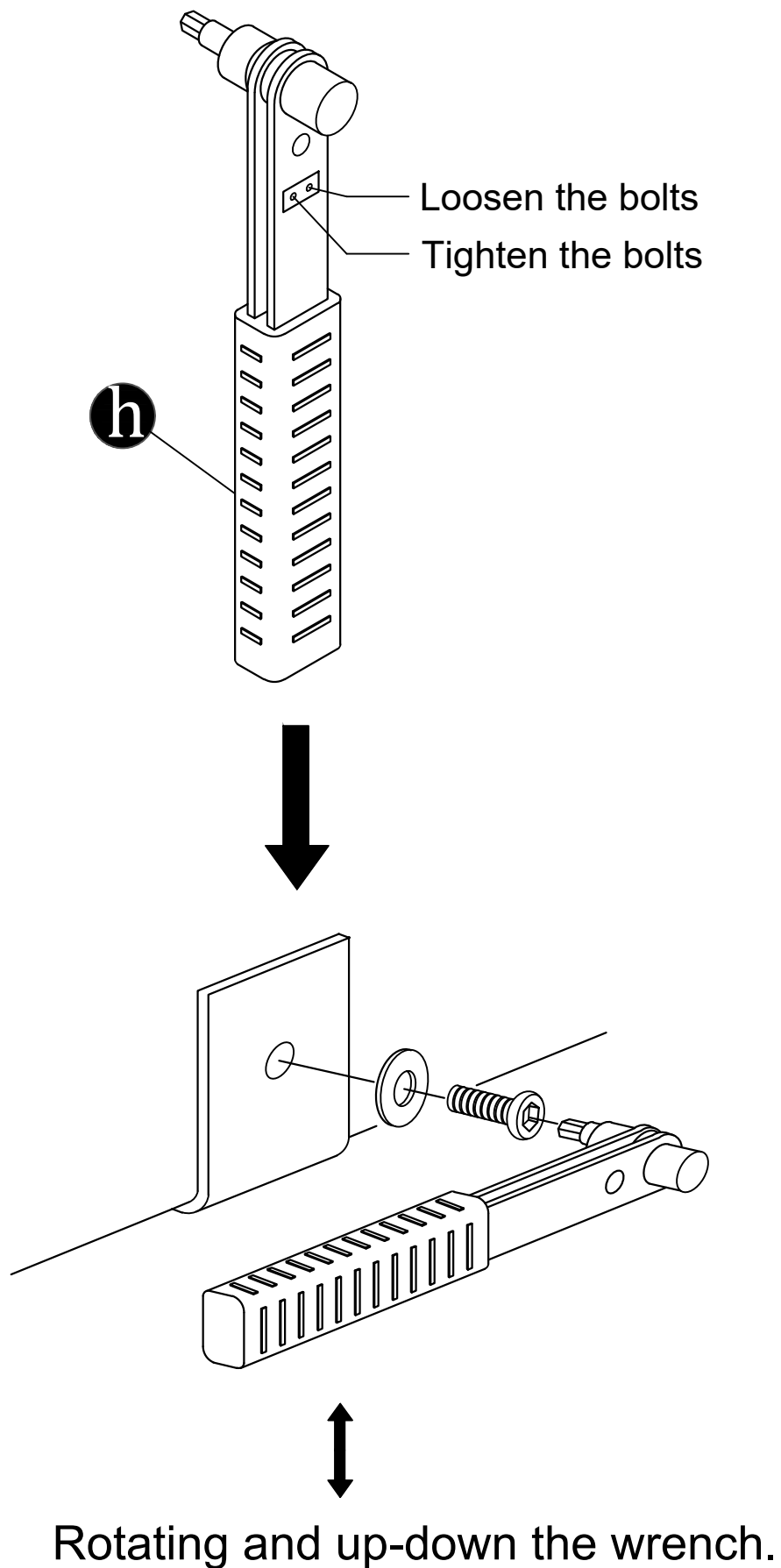



# The usage patten of component h .

## h Inside the side seat (BOX4)



# Assembly Instruction of Sofa

## Hardware parts

<b>a</b> 6*18MM Washer  x28	<b>b</b> 6*20MM Bolts  x14	<b>c</b> 6*30MM Bolts  x10	<b>d</b> 6*40MM Bolts  x4
<b>e</b> Allen Key  x1	<b>f</b> 4*4*18CM Connector  x4	<b>g</b> 4*6*6CM Connector  x6	<b>h</b> H4 Wrench  x1

## Structural accessories

<b>①</b> Sofa Leg  x4
--

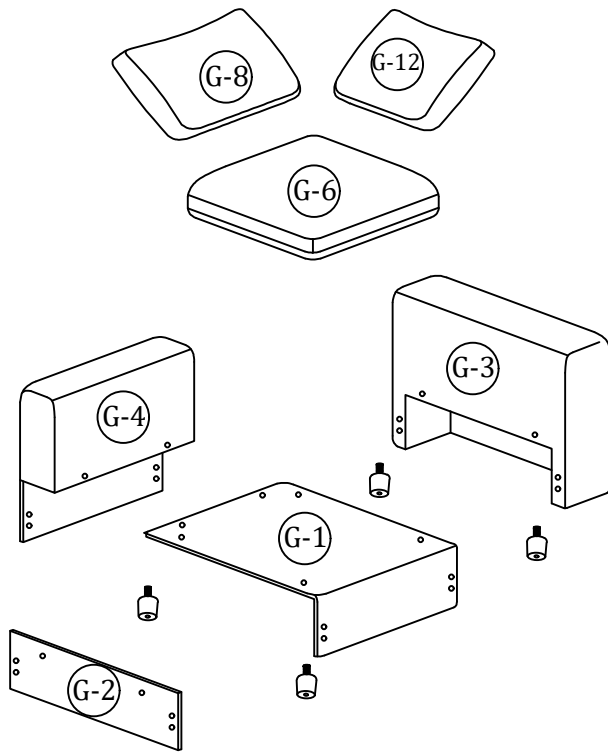

## Main structure accessories

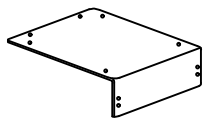

**G-1** 1pc  
Seat Frame

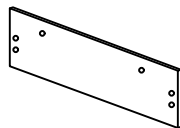

**G-2** 1pc  
Side Bezel

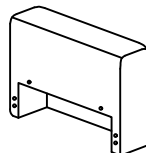

**G-3** 1pc  
Armrest

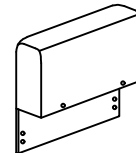

**G-4** 1pc  
Back Frame

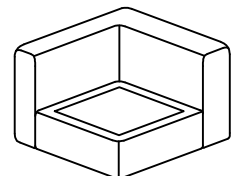

**G-5** 1pc  
Slipcover

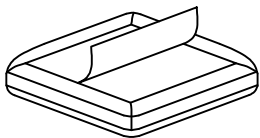

**G-6** 1pc  
Seat Pad Cover

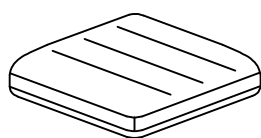

**G-7** 1pc  
Seat Foam



**G-8** 2pcs  
Back Cushion Cover

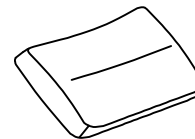

**G-9** 2pcs  
Back Cushion

# Assembly Instruction of Sofa

## Step 1

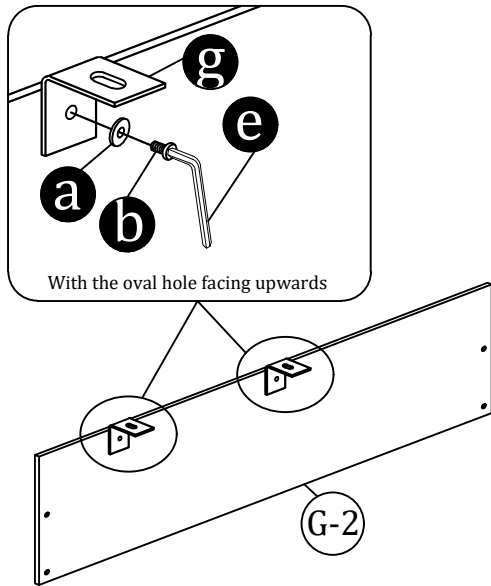

- e** ✓ 1PC
- g** L 2PCS
- b** 6\*20mm 2PCS
- a** 6\*18mm 2PCS

Attention: Do not fully tighten the screws until all the panels are in place. This will allow you to make adjustments and properly align the holes. Please tighten all the screws after all the holes are aligned.

## Step 2

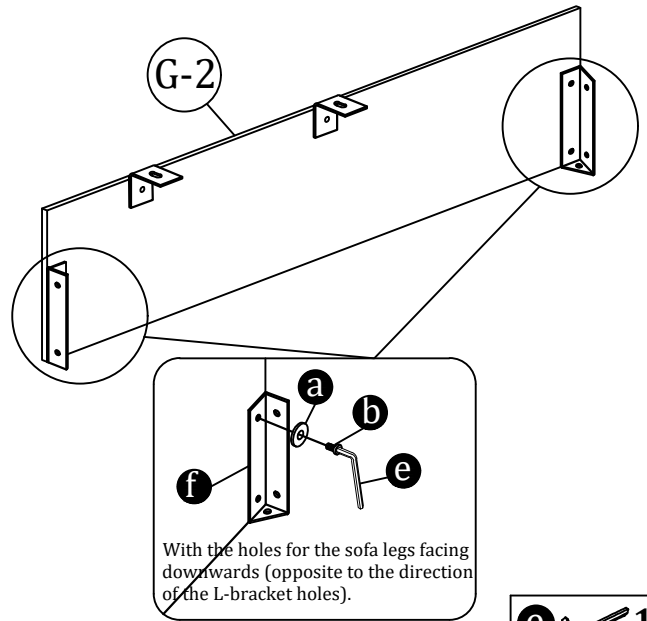

- e** ✓ 1PC
- f** L 2PCS
- b** 6\*20mm 4PCS
- a** 6\*18mm 4PCS

Attention: Do not fully tighten the screws until all the panels are in place. This will allow you to make adjustments and properly align the holes. Please tighten all the screws after all the holes are aligned.

## Step 3

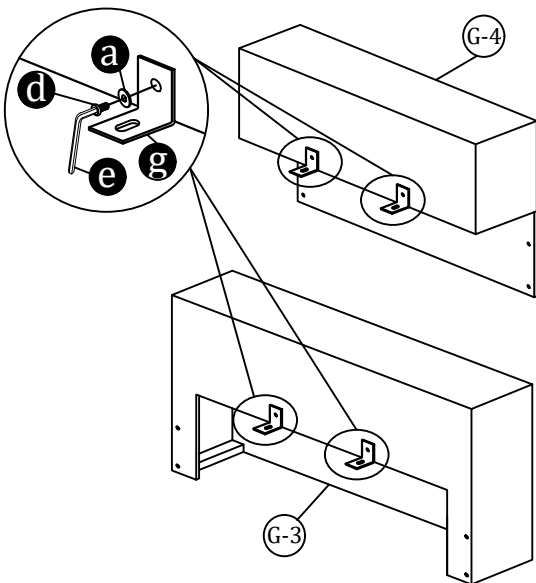

- e** ✓ 1PC
- g** L 4PCS
- d** 6\*40mm 4PCS
- a** 6\*18mm 4PCS

Attention: Do not fully tighten the screws until all the panels are in place. This will allow you to make adjustments and properly align the holes. Please tighten all the screws after all the holes are aligned.

## Step 4

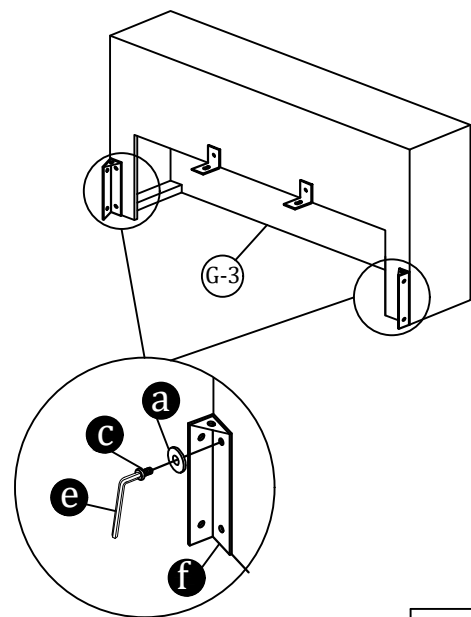

- e** ✓ 1PC
- f** L 2PCS
- c** 6\*30mm 4PCS
- a** 6\*18mm 4PCS

Attention: Do not fully tighten the screws until all the panels are in place. This will allow you to make adjustments and properly align the holes. Please tighten all the screws after all the holes are aligned.

# Assembly Instruction of Sofa

## Step 5

Attention: Do not fully tighten the screws until all the panels are in place. This will allow you to make adjustments and properly align the holes. Please tighten all the screws after all the holes are aligned.

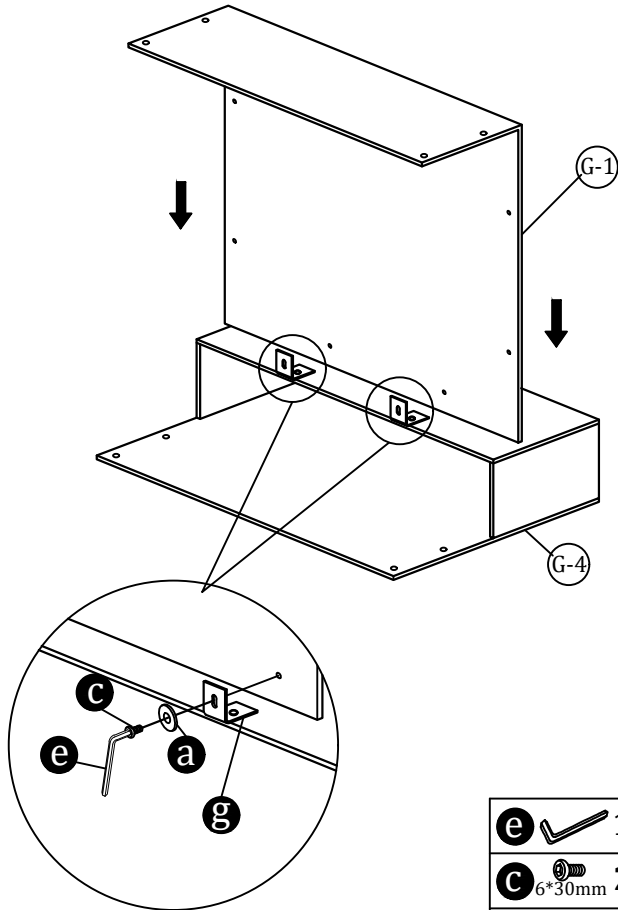

- e** ✓ 1PC
- c** 6\*30mm 2PCS
- a** 6\*18mm 2PCS

## Step 6

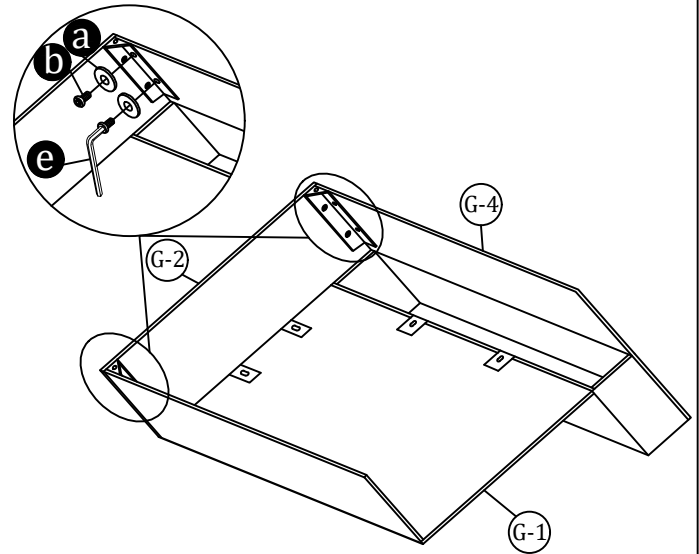

- e** ✓ 1PC
- b** 6\*20mm 4PCS
- a** 6\*18mm 4PCS

Attention: Do not fully tighten the screws until all the panels are in place. This will allow you to make adjustments and properly align the holes. Please tighten all the screws after all the holes are aligned.

## Step 7

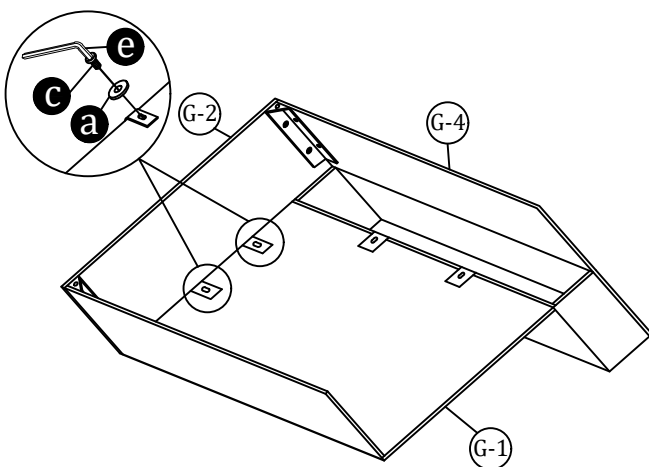

- e** ✓ 1PC
- c** 6\*30mm 2PCS
- a** 6\*18mm 2PCS

Attention: Do not fully tighten the screws until all the panels are in place. This will allow you to make adjustments and properly align the holes. Please tighten all the screws after all the holes are aligned.

## Step 8

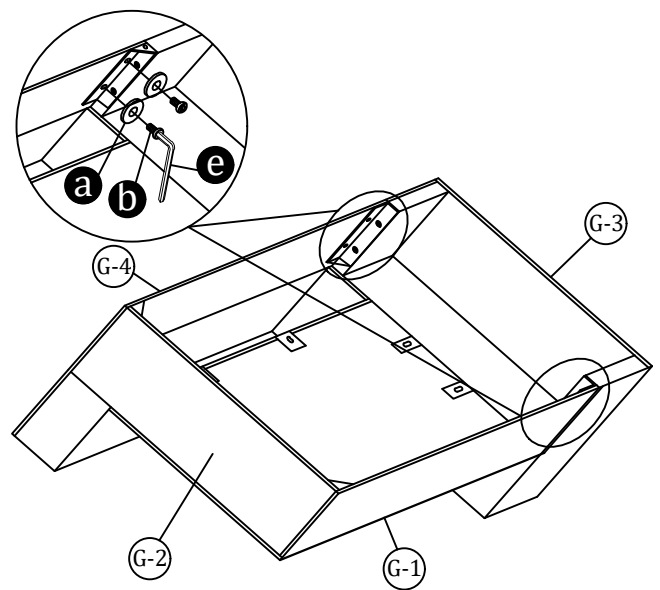

- e** ✓ 1PC
- b** 6\*20mm 4PCS
- a** 6\*18mm 4PCS

Attention: Do not fully tighten the screws until all the panels are in place. This will allow you to make adjustments and properly align the holes. Please tighten all the screws after all the holes are aligned.

# Assembly Instruction of Sofa

## Step 9

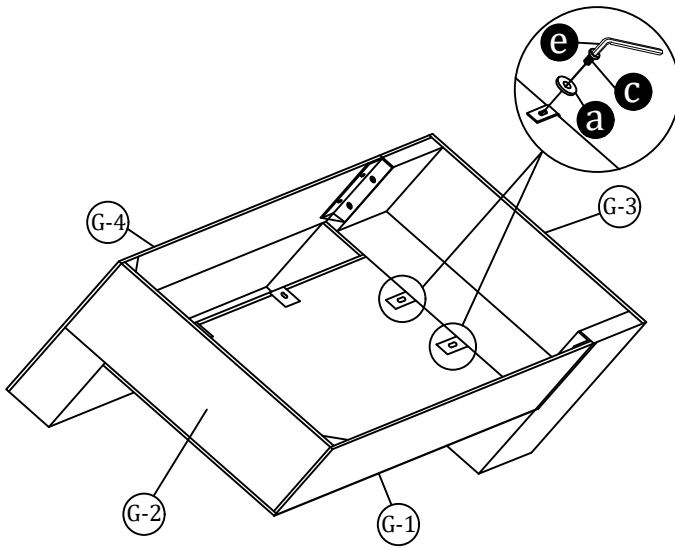

Align the sofa foot screw with the screw hole and tighten it to 100%

<b>e</b>		<b>1PC</b>
<b>c</b>		<b>6*30mm 2PCS</b>
<b>a</b>		<b>6*18mm 2PCS</b>

## Step 10

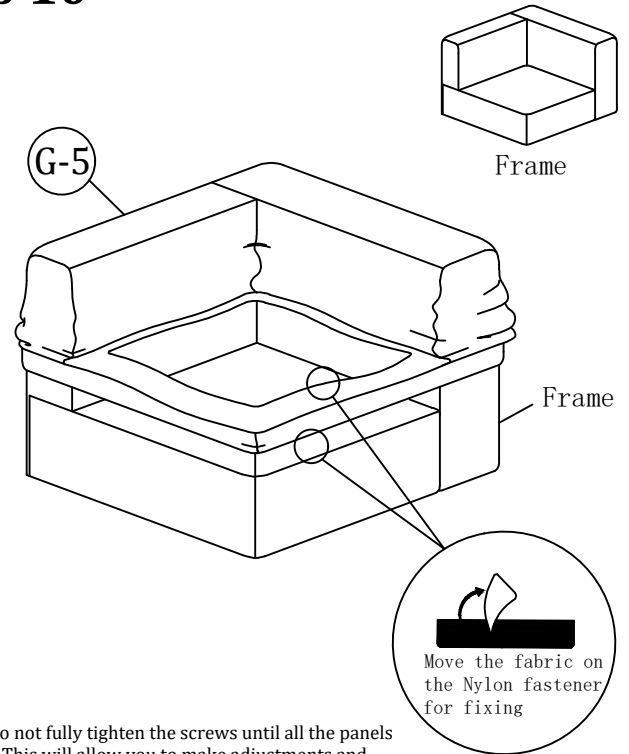

Attention: Do not fully tighten the screws until all the panels are in place. This will allow you to make adjustments and properly align the holes. Please tighten all the screws after all the holes are aligned.

Use (G-5) (slipcover) to cover all the components.

## Step 11

Pay attention to the installation position of the sofa feet

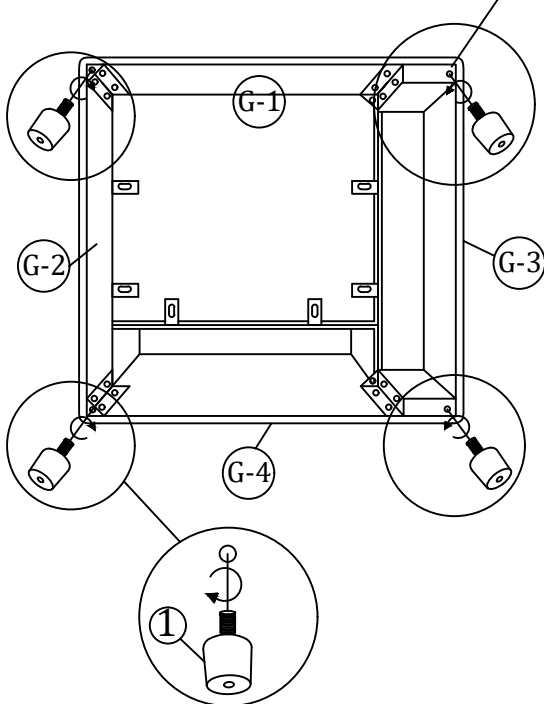

<b>1</b>		<b>4PCS</b>
----------	--	-------------

## Step 12

2) Take out the Seat Foam (G-7) and Seat Pad Cover (G-6)

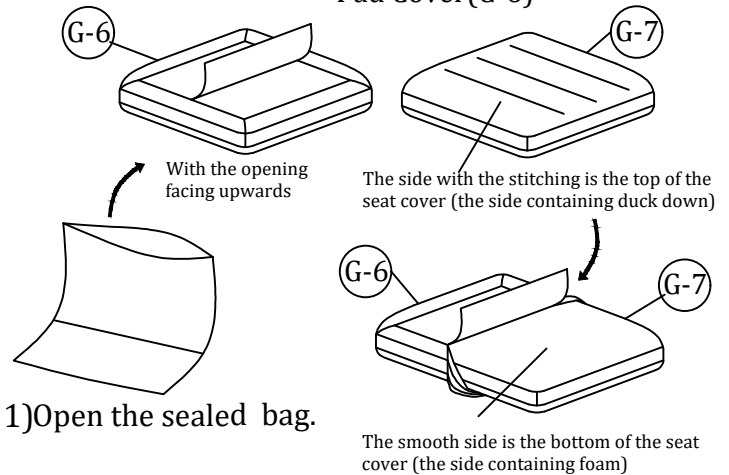

1) Open the sealed bag.

3) Place the opening side of the seat cover (G-6) facing upwards, then align the bottom side of the seat cushion (G-7) with the corners and insert it into the seat cover (G-6).

5) Please keep the white side up and front.

4) Zip UP



# Assembly Instruction of Sofa

## Step 13

2) Take out the Back Cushion(G-9) and Back Cushion Cover(G-8)

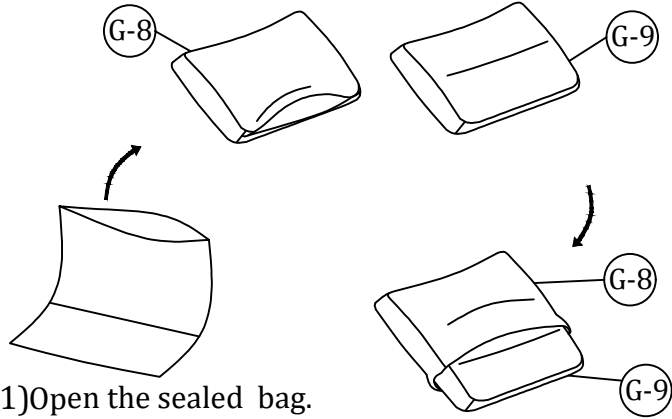

3) Insert the Back Cushion(G-9) into the Back Cushion Cover(G-8).

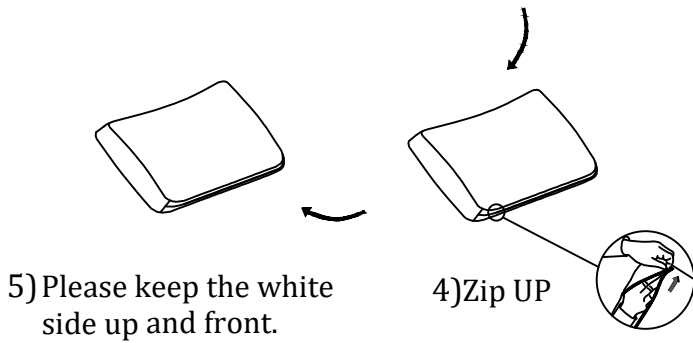

## Step 14

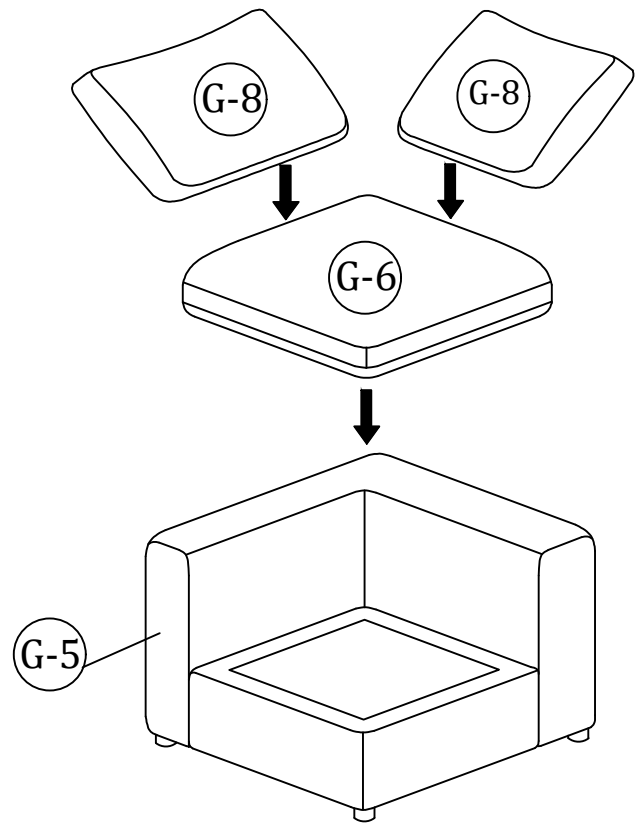

## Step 15

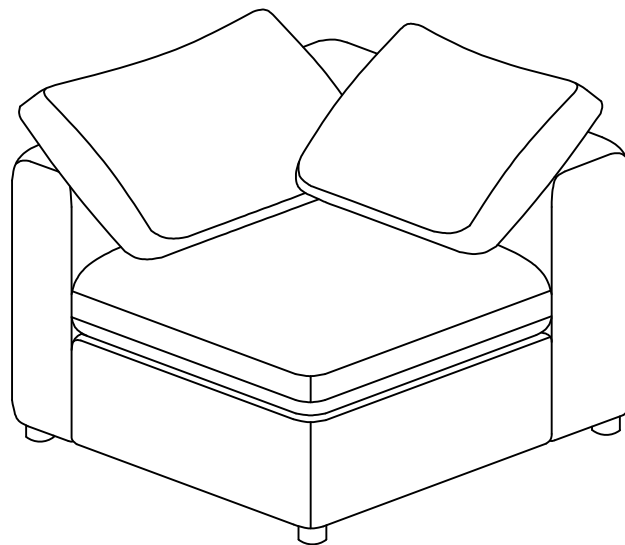

# Assembly Instruction of Sofa

