

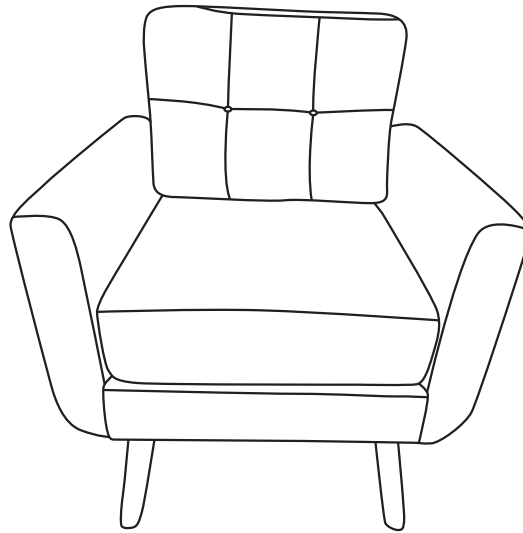

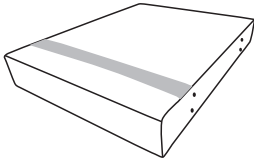



ASSEMBLY INSTRUCTION

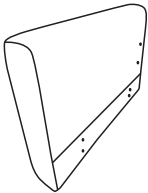
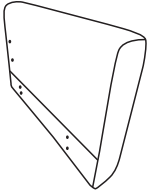
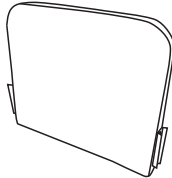
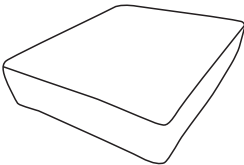
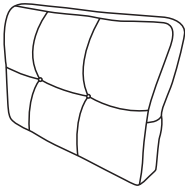
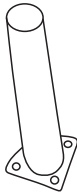

PARTS LIST

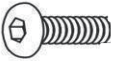
<p>A</p>  <p>Tips:  Velcro</p> <p>1PC</p>	<p>B</p>  <p>1PC</p>	<p>C</p>  <p>1PC</p>	<p>D</p>  <p>1PC</p>	
<p>E</p>  <p>1PC</p>	<p>F</p>  <p>1PC</p>	<p>G</p>  <p>4PCS</p>	<p>H</p>  <p>4PCS</p>	
<p>J</p>  <p>2PCS</p>	<p>K</p>  <p>M6x18mm</p> <p>16PCS</p>	<p>L</p>  <p>M6x35mm</p> <p>8PCS</p>	<p>M</p>  <p>ø6x18mm</p> <p>4PCS</p>	<p>N</p>  <p>M6</p> <p>1PC</p>

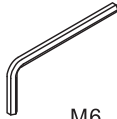
Installation Steps

STEP 1

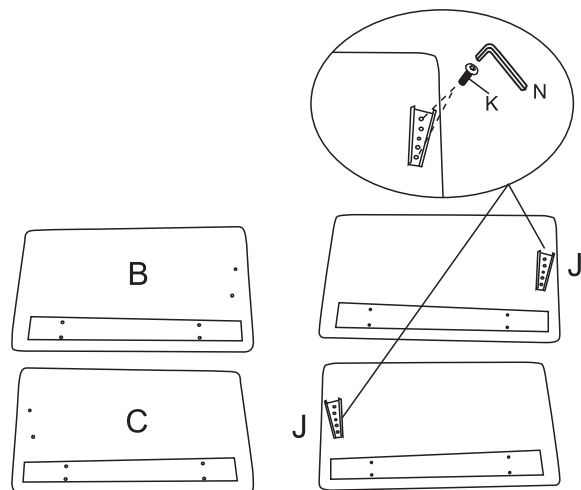

Attach part J to the screw holes of B and C using parts K and N.

STEP 2

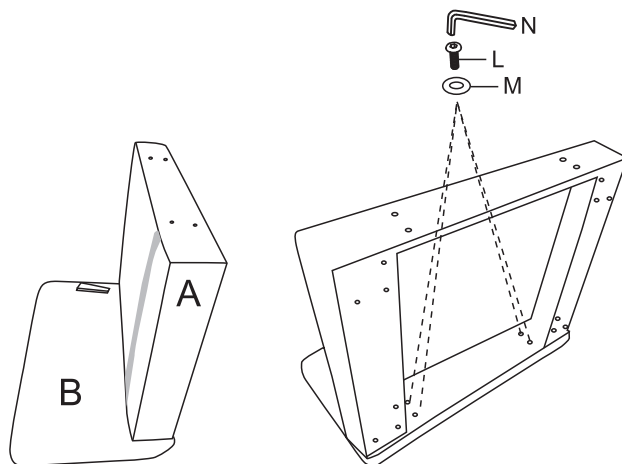

Align the screw holes in parts A and B. Insert part L into the holes of part M and the corresponding screw holes. Tighten the screws with part N.

STEP 3

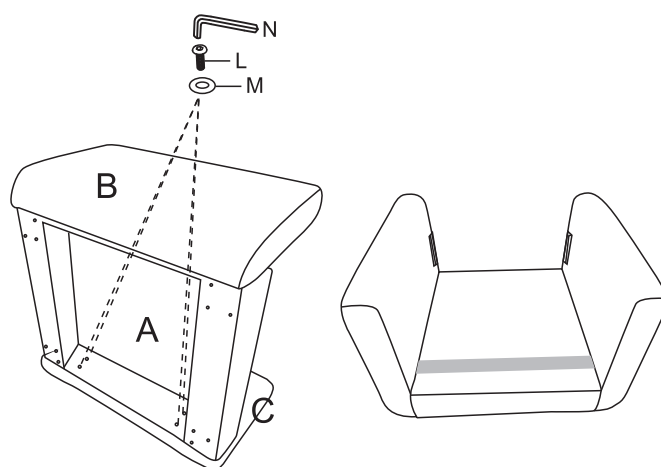

Align the screw holes in parts A and C. Insert part L into the holes of part M and the corresponding screw holes. Tighten the screws with part N.

Installation Steps

STEP 4

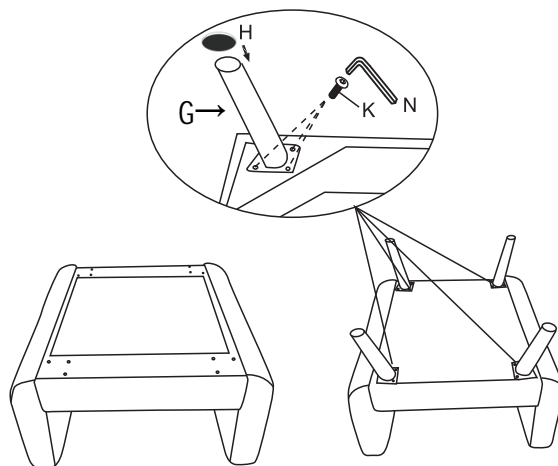

Attach part G to the bottom of the part A using parts K and N, paste part H to the bottom of the wooden leg

STEP 5

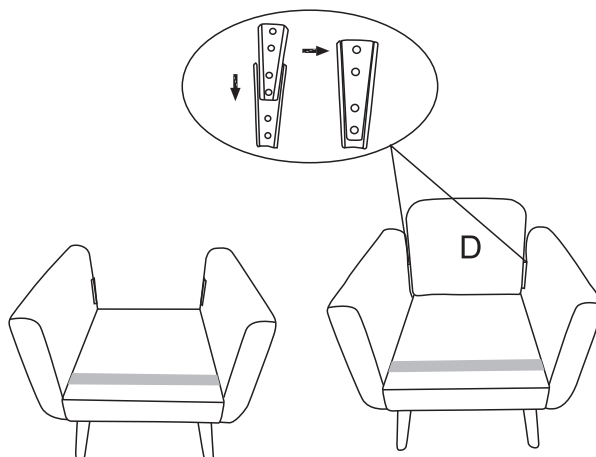

Insert part D, ensuring the parts align properly to make the connection.

STEP 6

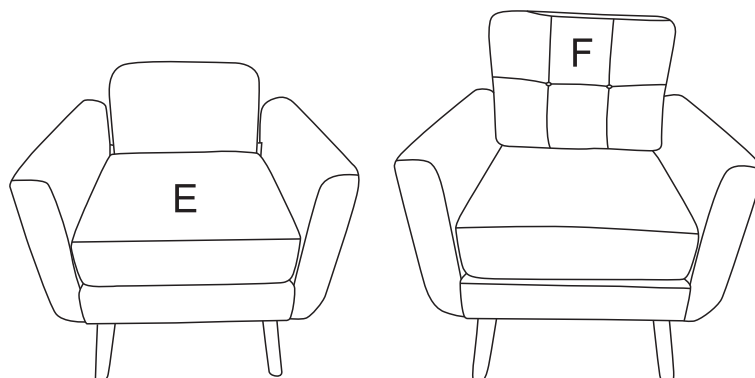

Place part E onto the seat and part F onto the backrest.
(Note: After unpacking parts E and F, gently tap them and allow 48 hours for them to return to their pre-compressed state.)