

Tools Recommended

EN_IMPORTANT, RETAIN FOR FUTURE REFERENCE: READ CAREFULLY.

FR_IMPORTANT: A LIRE ATTENTIVEMENT ET À CONSERVER POUR CONSULTATION ULTÉRIEURE.

ES_IMPORTANTE, LEA Y GUARDE PARA FUTURAS REFERENCIAS.

PT_IMPORTANTE, RETER PARA REFERÊNCIA FUTURA: LEIA ATENTAMENTE.

DE_WICHTIG! SORFGFÄLTIG LESEN UND FÜR SPÄTERES NACHSCHLAGEN AUFBEWAHREN.

IT_IMPORTANTE! CONSERVARE IL PRESENTE MANUALE PER FUTURO RIFERIMENTO E LEGGERLO ATTENTAMENTE.

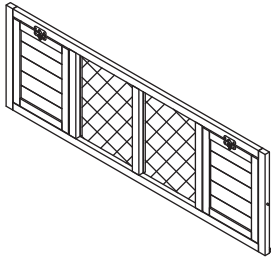

① x1

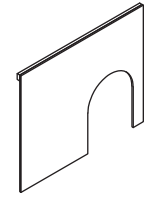

⑧ x1

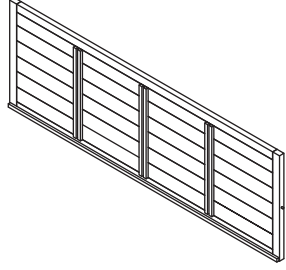

② x1

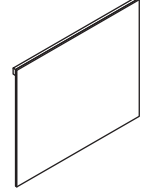

⑨ x1

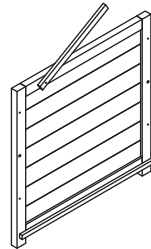

③ x1

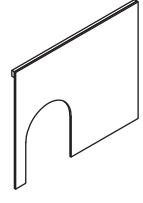

⑩ x1

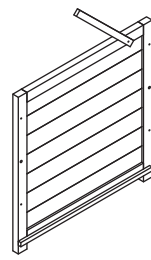

④ x1

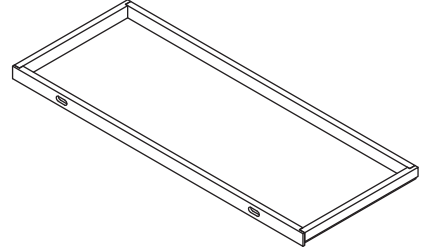

⑪ x1

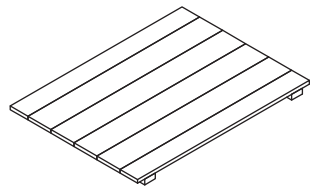

⑤ x2

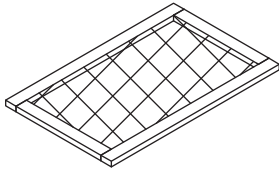

⑥ x2

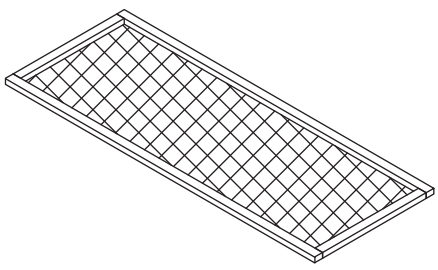

⑦ x1

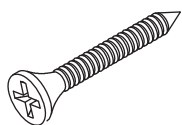
A x08+1(spare)

M3.5*40

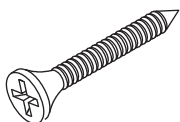
B x08+1(spare)

M3*18

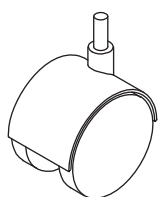
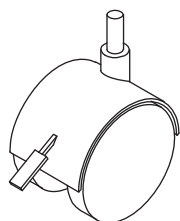
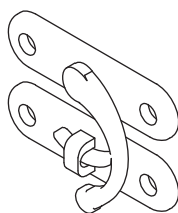
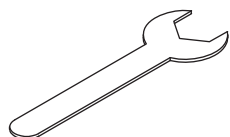
C x02**D** x02**E** x01**F** x01

EN_ Do not confuse similar screws.
FR_ Ne pas confondre des vis similaires.
ES_ No confunda tornillos similares.
PT_ Não confundir parafusos semelhantes.
DE_ Verwechseln Sie ähnliche Schrauben nicht.
IT_ Non confondere le viti simili.

NOTE

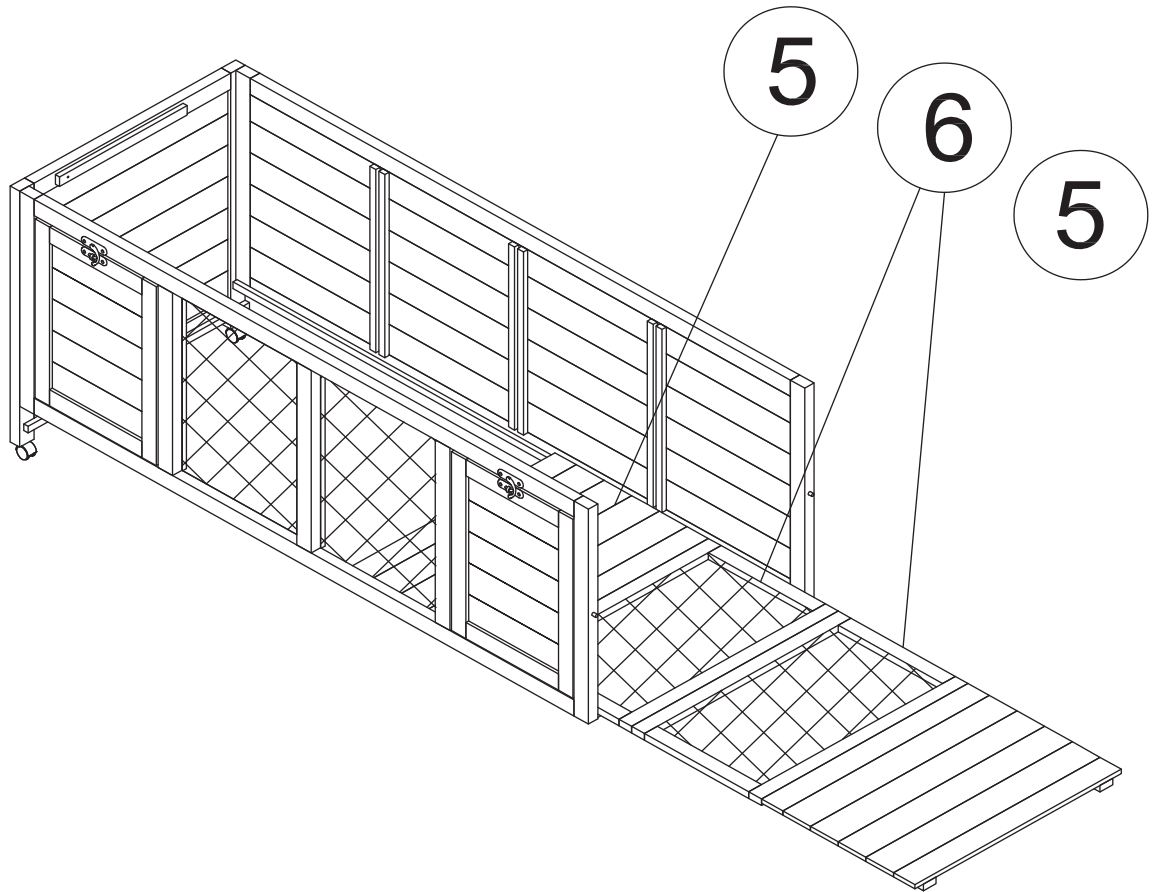
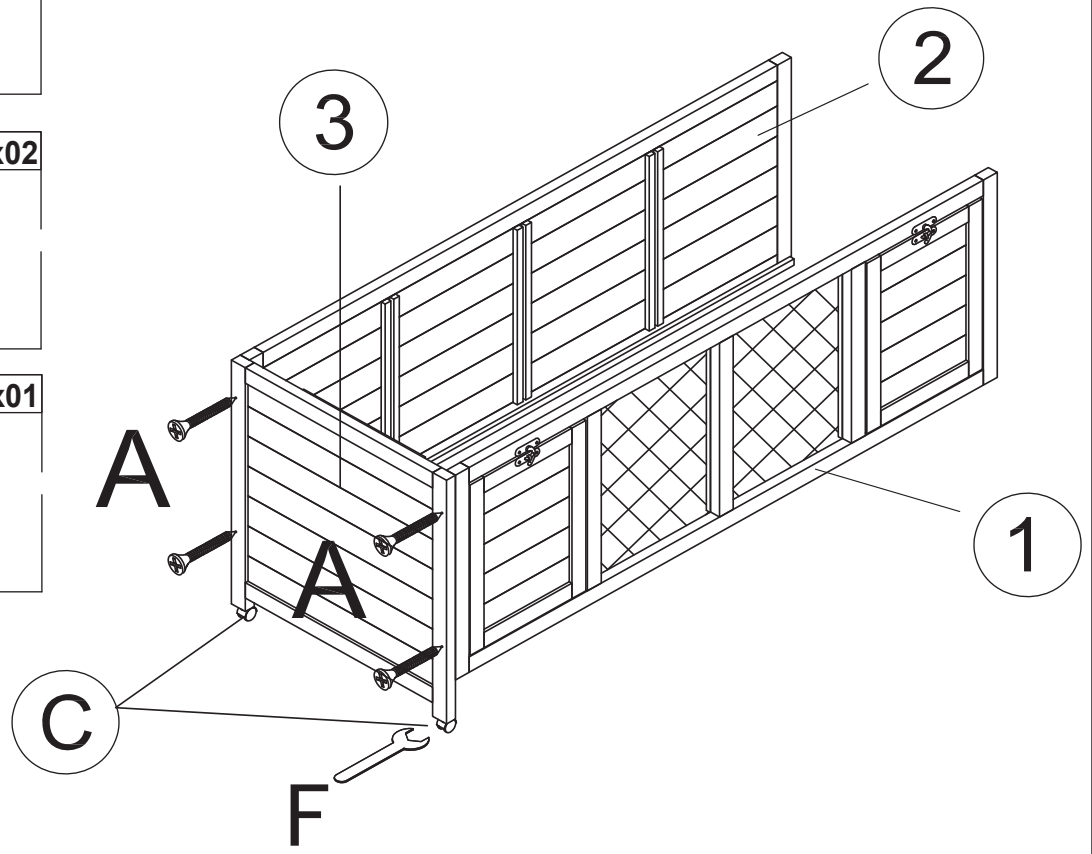
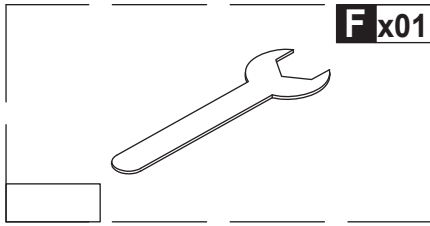
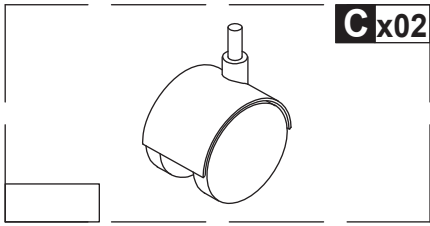
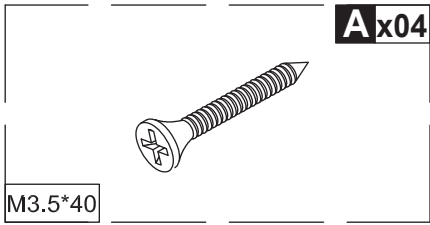

Ax04

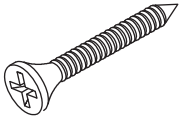

M3.5*40

Dx02

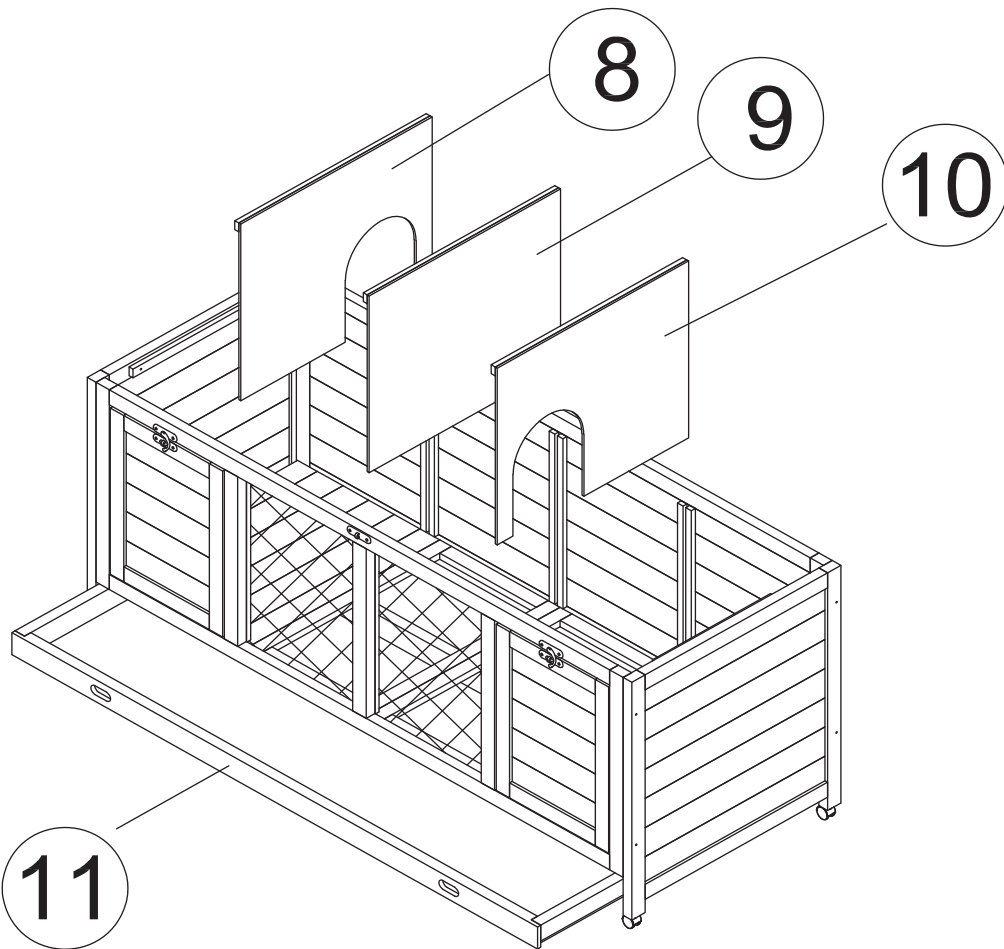
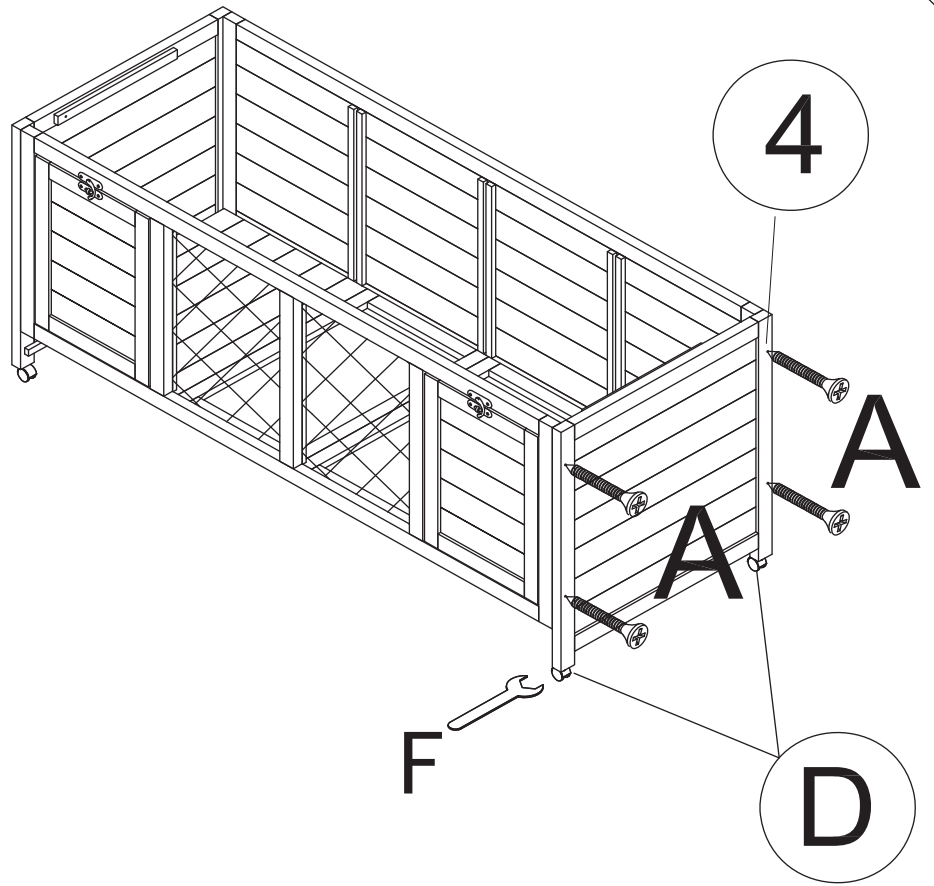
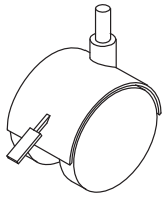

Bx04

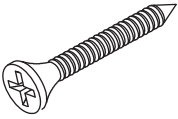

M3*18

7

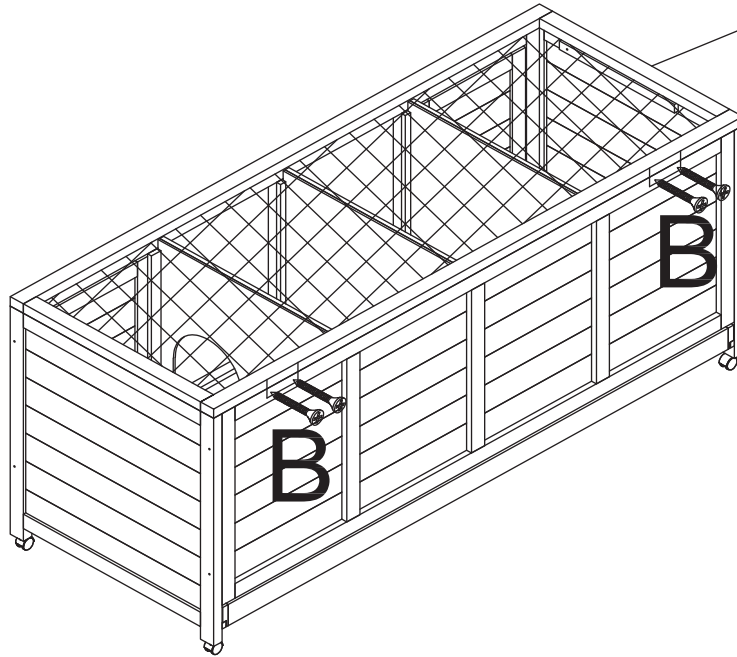

Bx04

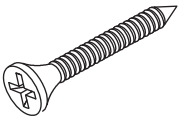

M3*18

Ex01

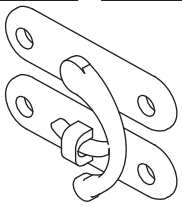

B

B

E

