

# USE & CARE GUIDE

---

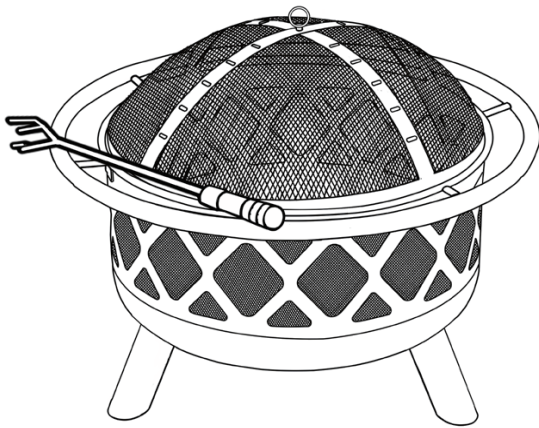

## ☰ ROUND STEEL FIRE PIT

⚠ Read the assembly instructions carefully!

⚠ Use the fireplace only outside!

🚫 Don't move the fireplace while using!









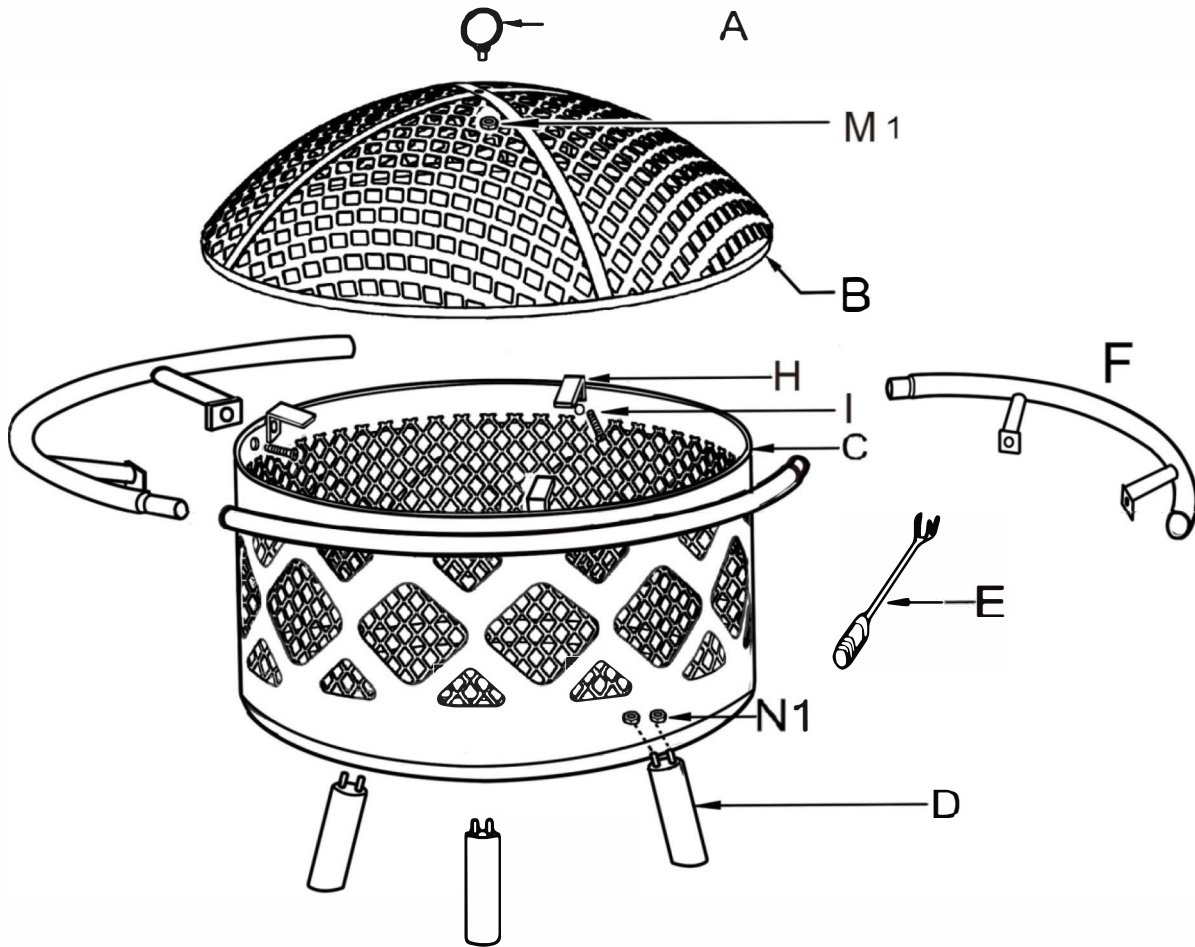

🚫 Caution! Hot! Use gloves!  
Children have to stay away of the fireplace!

# ASSEMBLY

Keep plastic bags out of the reach of children and dispose of safely. Please read the safety recommendations before use. Keep these instructions in safe place for future reference.

Before starting read these instructions carefully. We suggest you carry out assembly on a soft surface so as to avoid scratching the paint.



Part	Picture	Description	Qty
A		Mesh Spark Guard Handle	1
B		Mesh Screen	1
C		Fire bowl	1
D		Leg	3
E		Poker	1
F		A Fence Tube	3
H		Mesh Support Chip	3
I		Screw M6x15mm	6
M1		Nut M 6	1
N1		Nut M 8	6

## USER INSTRUCTIONS OUTDOORS

Please read the following instructions and recommendations and use **CAUTION** at all times for the safe enjoyment of a real patio fire. Please keep these instructions in a safe place so you can read them again from time to time.

**ALWAYS FOLLOW THE USER INSTRUCTIONS.** Failure to do so may result in personal accidents or fires spreading to property. Please remember, you are dealing with a real fire.

- PLACE your real patio fire on a **FLAT** surface; you should **NOT** place on a sloping surface where the fire might tip over.
- This should be a **NON-FLAMMABLE** surface such as stone, gravel or bricks. Do not place on grass which may turn brown. Do not place on wood which may turn brown or catch fire. **DO NOT PLACE ON DECKING** which may turn brown or catch fire.  
Protect wooden decking with a **FLOOR PROTECTION** or use bricks or concrete slabs.  
**DO NOT** place your fire near bushes or plants or under trees; the heat will damage the leaves and is a fire risk.
- **DO NOT** place your real fire under an awning; it will burn or melt.
- **DO NOT** place your real fire near garden furniture, especially made of fabric or woven plastic, which may melt or catch fire. We recommend at least one metre distance.
- **DO NOT** make a real fire inside a conservatory or summer house or shed; real fires are designed to be outside, and fumes emanating from the fire made with wood, coal or charcoal are toxic and dangerous to health. You can use your patio fire indoors **ONLY WHEN USING WITH THE CHIM BURNER AND BIO-ETHANOL FUEL.**
- **DO NOT** touch the real fire when burning; the surface is hot and you will burn your fingers; protect your hands with a **FIRE GLOVE**. We recommend that gloves are used at all times.
- **DO NOT** allow children, especially small children, near the fire. Do not allow pets near the fire.
- **DO NOT** allow children to play or run around the fire. It is not a game. Use a **CHIMENEA GUARD** to prevent small children coming close to the fire.
- **DO NOT** over fuel the fire. If flames are coming out of the top of the fire bowl, then the fire is too large.
- **DO NOT PANIC** if fuel falls out of the fire or for any reason flames spread out from the patio fire, simply extinguish spreading flames with earth or sand or with water immediately.  
**DO NOT** throw water on a real fire other than in an emergency.
- **DO NOT** use petrol, paraffin or similar substances as fire lighters or as a fuel. The best method is balled newspaper and kindling, such as **OCOTE** sticks. The best fuel is wood or charcoal.
- **NEVER LEAVE A BURNING REAL PATIO FIRE UNATTENDED.** Failure to do so may result in the fire spreading out of control and result in damage or destruction of property. Please ensure the fire is completely out before leaving the real patio fire unattended.
- **DO NOT** attempt to move a real patio fire while the fire is burning.
- We advise against using a real patio fire when it is windy or in the case of droughts. Strong wind may tip the fire bowl over which is a fire risk. Wind may also disperse burning material, which is a fire risk, particularly if the environment is dry as in the case of a drought.
- Please be a good neighbour and be reasonable in the use of your patio fire, keep smoke and noise to a minimum.

## SPECIFIC INSTRUCTIONS FOR YOUR FIRE BOWL

- Use your fire bowl for warmth, Fire bowls are beautiful to look at and can be used as garden decorations.
- You may use dry wood logs, charcoal, coal or briquettes for fuel. Fire bowls and other patio fires can be used to burn garden refuse such as leaves or branches. DO NOT throw fuel into a fire bowl. Wet logs will create a lot of smoke.
- The environmental friendly fuel is wood or charcoal which is carbon neutral.
- Wyre Forest Charcoal is made in the Wyre Forest in the UK West Midlands following to ancient rural methods.  
CHIM LOGS, which are made from environmentally friendly recycled sawdust and burn slowly with little smoke.
- To start a fire use domestic fire lighters or balled newspaper and kindling.
- The best and most natural way to start the fire is Ocote fire lighters. Ocote is a high resin content pinewood from Central America, one or two sticks are enough to light a fire.
- For a fire without firelighters or kindling, use the smokeless FIRE LOG, a wax impregnated sawdust briquette, wrapped in a paper. Just light both ends of the paper and the log will burn for about 2½ hours. You cannot use Fire Logs for cooking.
- Protect hands with FIRE GLOVES when adding fuel. The more fuel is added, the more intense the heat, the larger the flames. Do not over-fuel the fire.
- Use a POKER to reposition logs inside the patio fire.
- If the fire is slow to start, more air will help, use a BELLOWS to blow air into a slow fire.
- No one wants smoke to spoil their party, a EXTENSION CHIMNEY raises smoke above the heads of standing people and increases the draw enabling the fire to burn more efficiently.
- Safety is our main concern, please use a CHIMENEA GUARD to keep small fingers well away from the fire.
- Wood fuels burn by drawing air from above whilst charcoal and coal also need air from underneath. Some products are supplied with a charcoal grill and some have a BBQ grill. If you are using wood alone, you do not need a charcoal grill. If you are not cooking on your fire bowl, you may decide to remove the BBQ grill if there is one in your fire bowl.

## MAINTENANCE INSTRUCTIONS FOR YOUR FIRE BOWL

- Although your fire bowl is coated with heat-resistant paint, the PAINT WILL BURN OFF -this may Happen after one use only. The bigger the fire, the faster the paint will burn off.
- A fire bowl can be re-painted with high temperature resistant paint available from or local DIY store.
- Cast iron and steel corrode quickly in wet conditions and WILL RUST. Rusting is a natural phenomenon that cannot be prevented. It is not a product defect therefore we offer no guarantees against rusting. Corrosion may occur after one use only.
- A rusty fire bowl is still fit for purpose and can continue to be used. No refunds or replacements will be given for rusty fire bowls.
- Rust runs may mark flooring, slabs, and patios, so if you are worried about marking, protect your flooring.
- To reduce the likelihood of rusting, wipe the whole surface of the product with oil after each use. Use a rag or brush to that effect.
- Bring inside or protect with a weatherproof fire bowl cover. sell many sizes of covers in various quality grades. If the cover traps dampness underneath it, the fire bowl may still go rusty. Ideally, bring inside for the winter.
- To maintain the finish, clean the surface with a soft cloth. Do not use a wire brush. Slight wear and tear scratches may appear with normal use.

## COOKING ON A CHIMENEA OR FIRE BOWL OR BBQ

Special care and attention is necessary when cooking on a chimenea or fire bowl to avoid contamination by smoke or soot. All cooking accessories **MUST BE THOROUGHLY CLEANED BEFORE USE.**

- BBQ grills and accessories are coated with vegetable oil during manufacture but may have gathered dirt and dust therefore must be thoroughly washed in hot water and detergent, check all dirt is removed.
- After cleaning and drying, cooking accessories are best lightly coated with vegetable cooking oil before use. After use, they must be washed clean with hot water and detergent and coated with vegetable cooking oil before storing. **NEVER USE MINERAL OIL.**
- If you do not oil cooking accessories they will rust, this could happen after first use. If you wash cooking accessories with water and don't coat with cooking oil rust can occur in a matter of hours.
- After use the surfaces of the cooking accessories in direct contact with the fire will be covered in black carbon soot. Soot can be washed off with hot water and household detergent or washing up liquid. Be careful because black soot residues will mark surfaces, tea towels or washing up cloths. All soot must be removed before oiling and storage.

## FUEL

Do not cook on flames, if you do this there will be a soot residue on the food, which is unhealthy. Be aware wood is often treated with preservatives which are toxic and can contaminate the food.

- When cooking use dry wood or charcoal, and allow the wood gas to burn off as flames to leave hot glowing embers, cook on the embers.
- If meat releases fat onto the hot embers which makes a flame, move the meat away from the flame.
- Keep a spray bottle of water handy to squirt on any flames.
- Use a cast iron pan to grill meat rather than placing directly on a grill.
- Alternatively wrap food in aluminium foil to prevent contamination.

## FOOD HYGIENE AND SAFETY

When cooking outdoors take care food is kept in hygienic conditions.

- **DO NOT** leave meats in the sun or outside in hot weather, keep cool and covered with a clean cloth.
- **DO NOT** leave butter in the sun or uncovered.
- Keep meat and vegetables in separate dishes to avoid cross contamination with fluids.
- Only bring food out into the garden before cooking and it should be consumed after cooking as soon as possible. Food should be eaten while hot, immediately after coming out of the fire. Dispose of any cooked food not eaten.
- **MAKE SURE** meat is thoroughly cooked.
- When cooking accessories are taken out of the fire, they are hot and need to be put onto a hard non-flammable surface, so the contents of the cooking accessory can be removed.
- **DO NOT** place the cooking accessory on the patio, grass, earth or directly on the ground.
- **DO NOT** put hot cooking accessories directly onto wood, furniture, plates, crockery or plastic surface.
- Parts of the cooking accessories in direct contact with the fire may become covered with carbon soot. Make sure you do not contaminate your food with soot.
- **CAREFUL HOT! DO NOT TOUCH**, steel and cast iron cooking accessories are very hot when taken out of the fire, do not touch with your fingers, protect hands with **FIRE GLOVES.**
- Cast iron cooking accessories can remain hot after use, so **ALWAYS** be very careful and cautious when handling cast iron cooking accessories.
- **DO NOT** allow children to handle any of the cooking accessories.
- **NEVER** leave a cooking accessory in the fire unattended. If you leave food in the fire, it will be burnt and inedible.

## HINTS AND TIPS

- Cast iron accessories should be pre-heated for best results.
- Always coat the inside with oil or butter of all accessories to prevent food sticking.
- Butter tastes better than oil for waffles and pancakes.
- A small brush is useful for oiling or buttering surfaces.
- A flat spatula is useful to release foods from the accessory.

## WHICH COOKING ACCESSORIES SHOULD I USE?

Our cooking accessories are specially designed for use in chimeneas, fire bowls, barbecues or outdoor fires. The materials used are suitable for the greater intensity of outdoor fires, with long handles to ensure ease of use without burning your hands. It is NOT ADVISABLE TO USE KITCHEN PANS OR POTS to cook on patio fires. Kitchen pans may be designed for fires of less intensity and coated with plastic based non-stick materials which may melt in patio fires. cooking accessories are designed for cooking food on an open fire.

- The COOKING IRON is perfect for burgers, sausages, vegetables; it is multi-purpose. The
- TOASTIE IRON makes tasty sandwich toasties.
- The FRYING PAN is great for steaks, bacon, frying tomatoes and fried eggs.
- The POP CORN POPPER is great for entertaining children, who love watching popping corn.
- The PANCAKE PAN for making pancakes.
- The WAFFLE IRON for making waffles.
- The CHESTNUT PAN for roasting tasty chestnuts and can be used for cooking food wrapped in aluminium foil.
- The TOASTING FORK makes delicious toast and marshmallows, or to warm rolls or croissants. The
- PIZZA STONE is great for making pizzas the Italian way.
- Use the removable CHIM BBQ GRILL on clay chimeneas, for cooking food on BBQ grill
- Your cast iron or steel chimenea may already be equipped with a SWIVELLING BBQ GRILL, made of either chromed steel or cast iron for barbecuing on your chimenea. These can also now be purchased separately from the chimenea.
- The SWIVELLING HOT PLATES AND FRYING PANS can be fitted in place of the BBQ grill on most steel

## MORE RECOMMENDATIONS

All cooking accessories, whether supplied with the product or separately must be washed before first use to remove any dirt due to manufacture or packaging operations. We recommend you wash them before use every time subsequently, even if they were put away clean.

All cast iron cooking accessories including BBQ grills and hot plates are coated with vegetable oil to stop rusting when you first receive them. After use, all cooking accessories need to be cleaned in soapy water to remove soot and cooking residue. Dry them well after cleaning and immediately coat them with vegetable oil before putting away. Failure to coat with vegetable oil will mean the accessory will start rusting. NEVER use mineral oil which is harmful to human health. For cooking accessories purchased separately from this product, follow the cooking instructions supplied with the packaging.

If your chimenea is equipped with a swivelling cast iron BBQ grill, remember to remove and wash it thoroughly and coat it with vegetable oil before and after use. Put food directly onto the BBQ grill, either pre-heated or not. For pizzas, use the pizza stone. Use the multi-purpose tool provided to swivel the BBQ grill in and out. Never touch the BBQ grill with your hands while hot. A cast iron BBQ grill will remain hot a long time after use, even if taken out of the chimenea.