

# ASSEMBLY INSTRUCTIONS

## MAXIMUS COLLECTION





U1754-20A  
U1754-20B



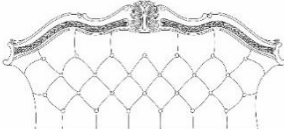
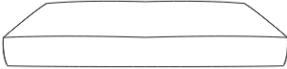

MAXIMUS LOVESEAT FRAME, CUSHION, ARMS, LEGS & 3 PILLOWS  
MAXIMUS LOVESEAT BACKREST

Thank you for purchasing this quality product. Be sure to check all packing materials carefully for small parts, which may have come loose inside the carton during shipment. Identify and count all items and compare with the PARTS LIST and/or HARDWARE LIST shown below.

**CAUTION: Read the instructions carefully before assembly.**

1. We recommend that you assemble this product with the assistance of another person to eliminate damage to the product during assembly.
2. When you want to reposition the product, please always "LIFT & MOVE."

PARTS LIST			
NO.	DESCRIPTION	SKETCH	Q'TY (PCS)
A	SEAT FRAME		1
B	LEFT SIDE FACING (LSF) ARM		1
C	RIGHT SIDE FACING (RSF) ARM		1
D	BACKREST		1
E	SEAT CUSHION		1
F	LEG		4

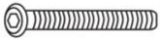
HARDWARE LIST			
NO.	DESCRIPTION	SKETCH	Q'TY (PCS)
1	FLAT WASHER Ø5/16 x 3/4"		11
2	WASHER Ø5/16 x 1/2"		11
3	BOLT Ø5/16 x 2 1/4"		8
4	ALLEN KEY Ø5/16 x 3/4"		1
5	BOLT Ø5/16 x 3/4"		3

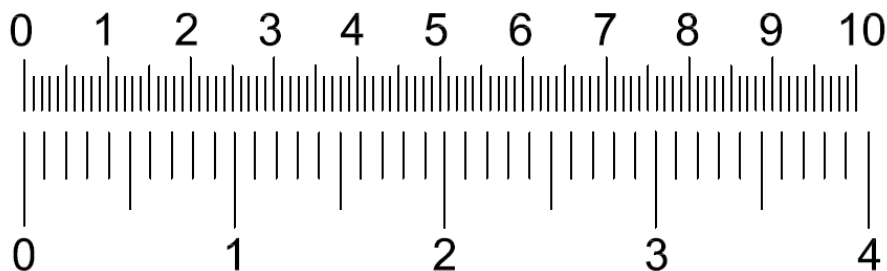

# ASSEMBLY INSTRUCTIONS

## MAXIMUS COLLECTION

U1754-20A  
U1754-20B

MAXIMUS LOVESEAT FRAME, CUSHION, ARMS, LEGS & 3 PILLOWS  
MAXIMUS LOVESEAT BACKREST

### STEP 1:

Lay the seat frame (A) on its back side to reach the holes to secure the bolts for the arms. Assemble the LSF arm (B) and RSF arm (C) to the seat frame (A) using Allen Key (4) with hardware, 1, 2, and 3.

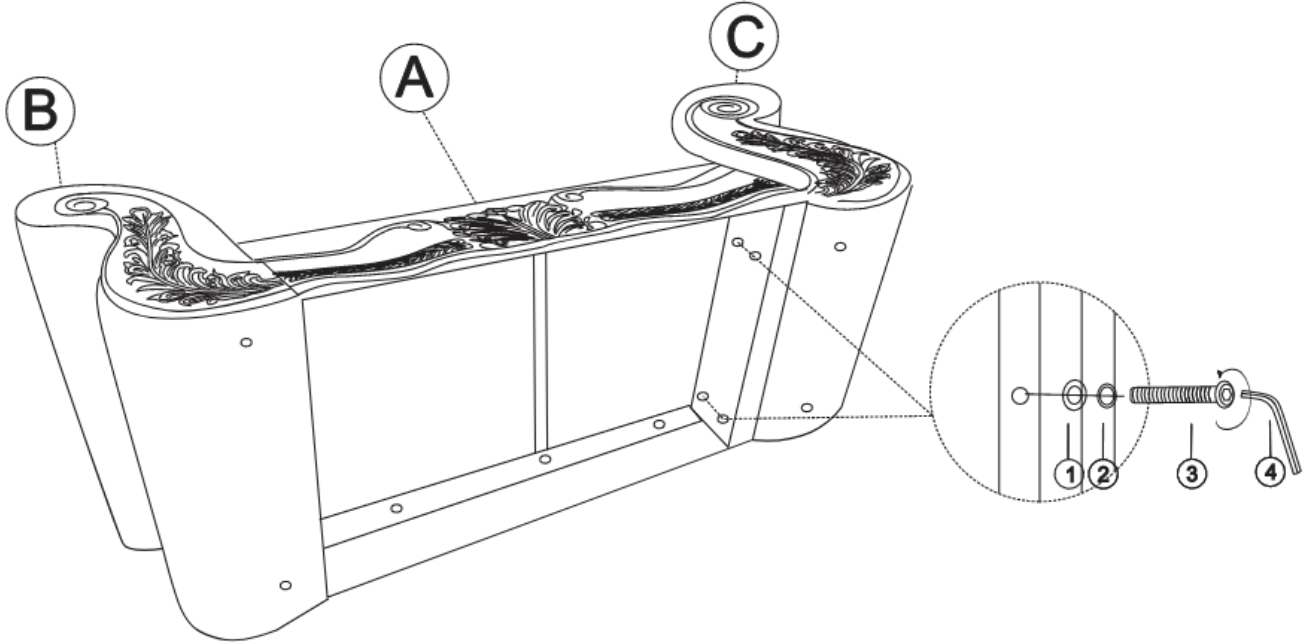

### STEP 2:

Align and install the legs (F) to the bottom of the arms (B & C)

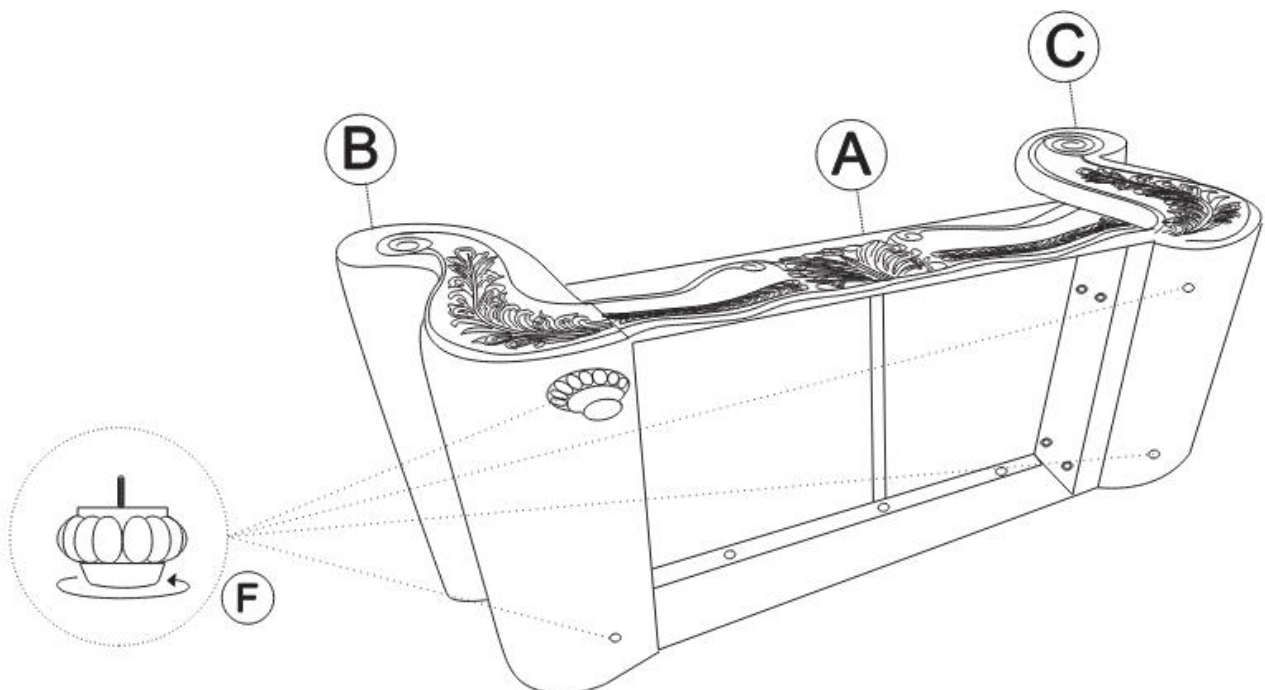

# ASSEMBLY INSTRUCTIONS

## MAXIMUS COLLECTION

U1754-20A  
U1754-20B

MAXIMUS LOVESEAT FRAME, CUSHION, ARMS, LEGS & 3 PILLOWS  
MAXIMUS LOVESEAT BACKREST

### STEP 3:

Place the frame up right and install the backrest (D) to the LSF arm (B) and RSF arm (C) by sliding the brackets all the way until it is secured.

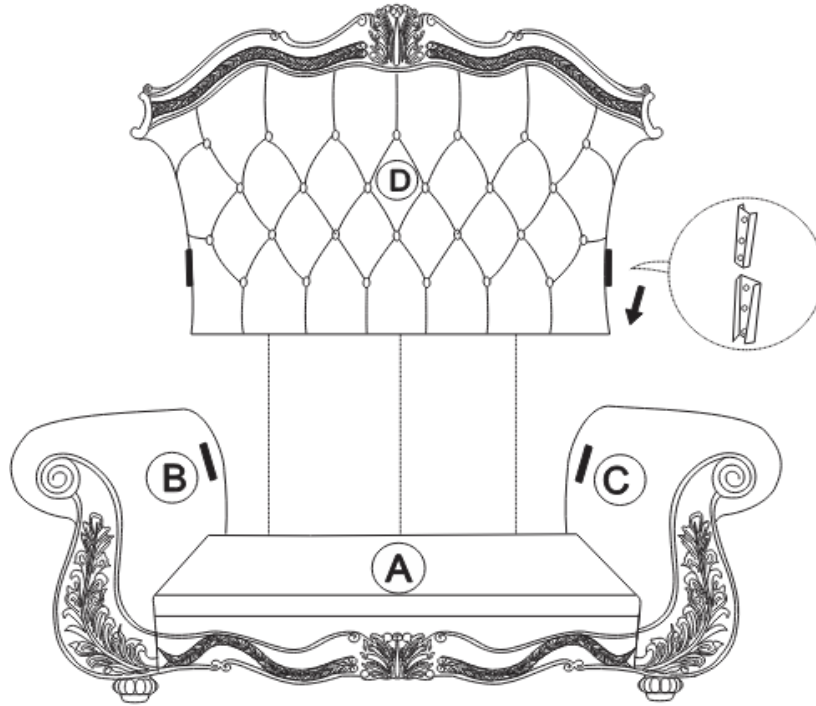

### STEP 4:

Place the chair on its back on a clean and soft surface and secure the bolts for the chair back (D) at bottom the seat frame (A) by using the Allen key (4) with hardware 1,2 and 5.

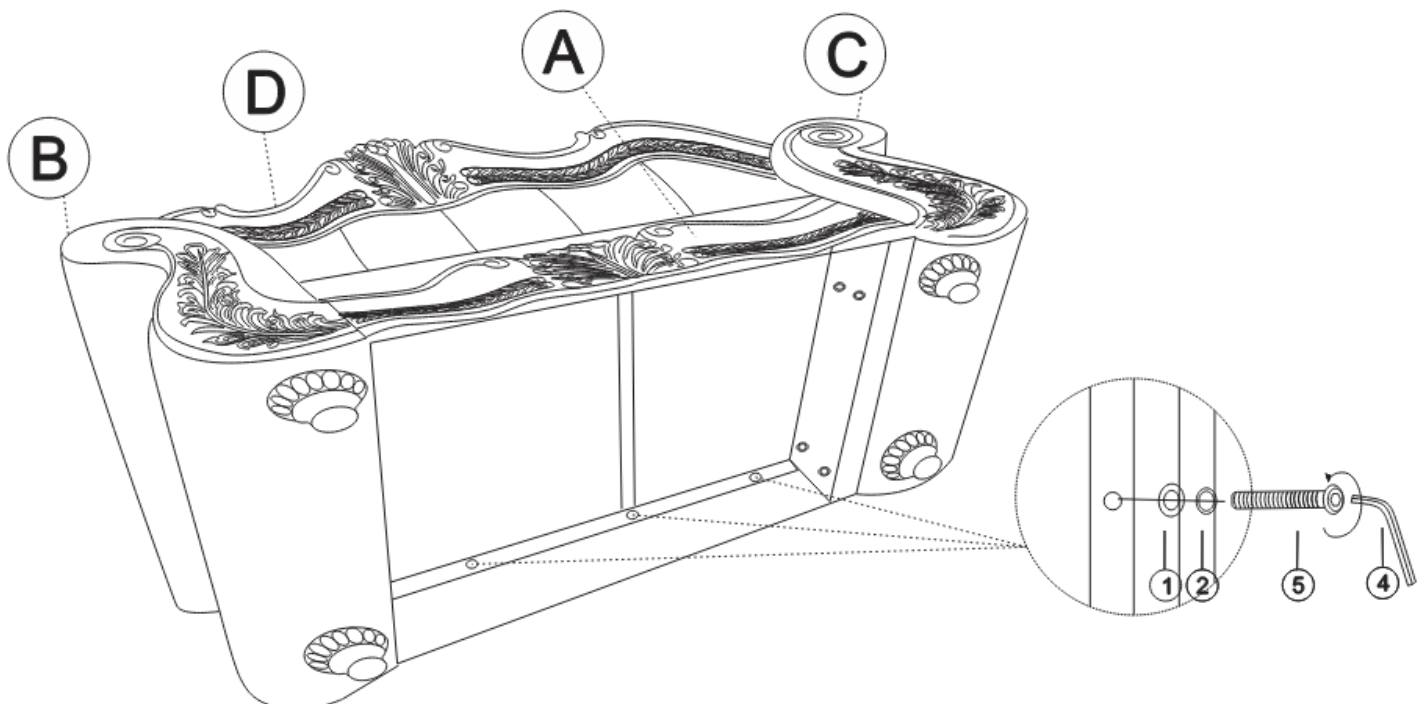

# ASSEMBLY INSTRUCTIONS

## MAXIMUS COLLECTION

U1754-20A MAXIMUS LOVESEAT FRAME, CUSHION, ARMS, LEGS & 3 PILLOWS  
U1754-20B MAXIMUS LOVESEAT BACKREST

### STEP 5:

Place the frame up right and place the seat cushion (E) to the seat frame.

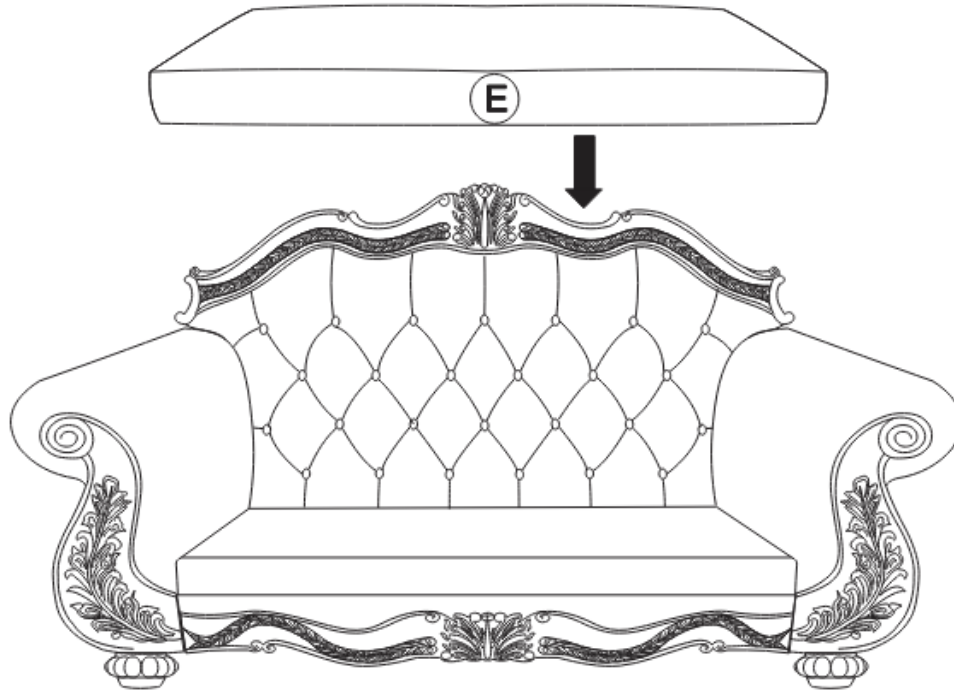

### FINISH

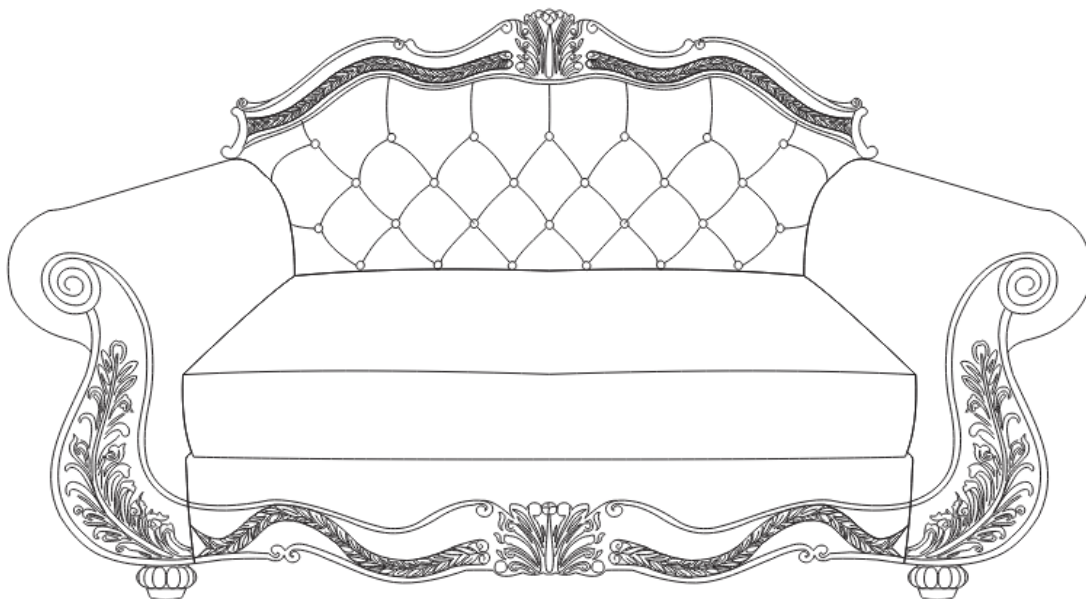

# ASSEMBLY INSTRUCTIONS

## MAXIMUS COLLECTION





U1754-30A  
U1754-30B



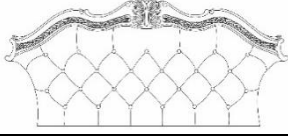
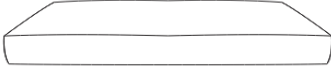

MAXIMUS SOFA FRAME, CUSHION, ARMS, LEGS & 5 PILLOWS  
MAXIMUS SOFA BACKREST

Thank you for purchasing this quality product. Be sure to check all packing materials carefully for small parts, which may have come loose inside the carton during shipment. Identify and count all items and compare with the PARTS LIST and/or HARDWARE LIST shown below.

**CAUTION: Read the instructions carefully before assembly.**

1. We recommend that you assemble this product with the assistance of another person to eliminate damage to the product during assembly.
2. When you want to reposition the product, please always "LIFT & MOVE."

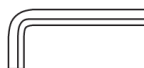
PARTS LIST			
NO.	DESCRIPTION	SKETCH	Q'TY (PCS)
A	SEAT FRAME		1
B	LEFT SIDE FACING (LSF) ARM		1
C	RIGHT SIDE FACING (RSF) ARM		1
D	BACKREST		1
E	SEAT CUSHION		1
F	LEG		4
G	SUPPORT LEG		1

HARDWARE LIST			
NO.	DESCRIPTION	SKETCH	Q'TY (PCS)
1	FLAT WASHER Ø5/16 x 3/4"		11
2	WASHER Ø5/16 x 1/2"		11
3	BOLT Ø5/16 x 2 1/4"		8
4	ALLEN KEY Ø5/16 x 3 1/4"		1
5	BOLT Ø5/16 x 3 1/4"		3

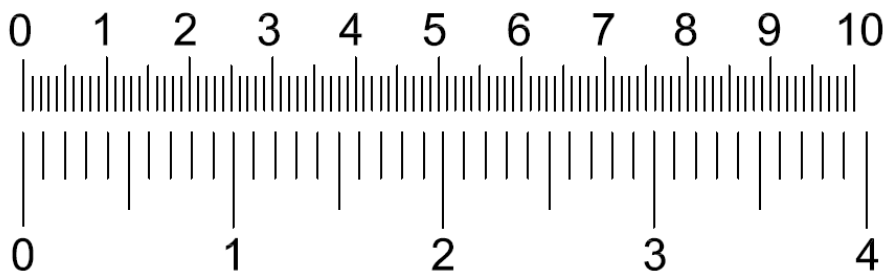

# ASSEMBLY INSTRUCTIONS

## MAXIMUS COLLECTION

U1754-30A  
U1754-30B

MAXIMUS SOFA FRAME, CUSHION, ARMS, LEGS & 5 PILLOWS  
MAXIMUS SOFA BACKREST

### STEP 1:

Lay the seat frame (A) on its back side to reach the holes to secure the bolts for the arms. Assemble the LSF arm (B) and RSF arm (C) to the seat frame (A) using Allen Key (4) with hardware, 1, 2, and 3.

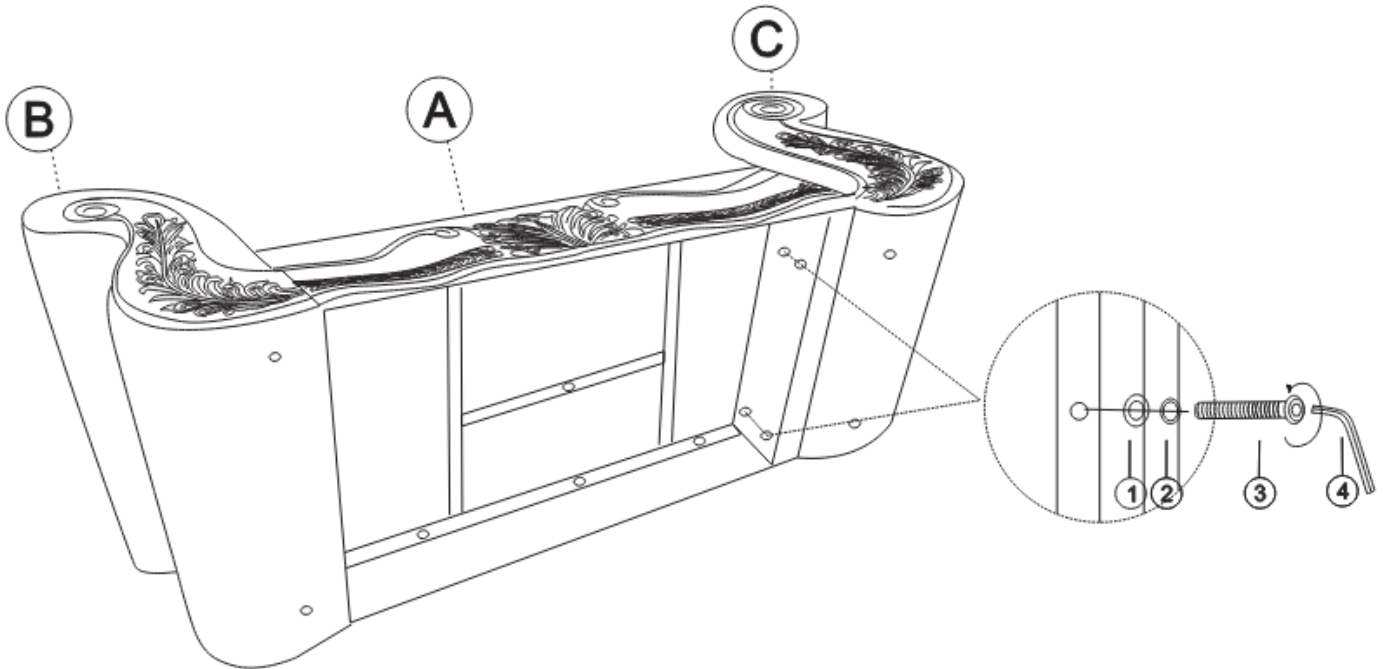

### STEP 2:

Align and install the legs (F) to the bottom of the arms (B & C)

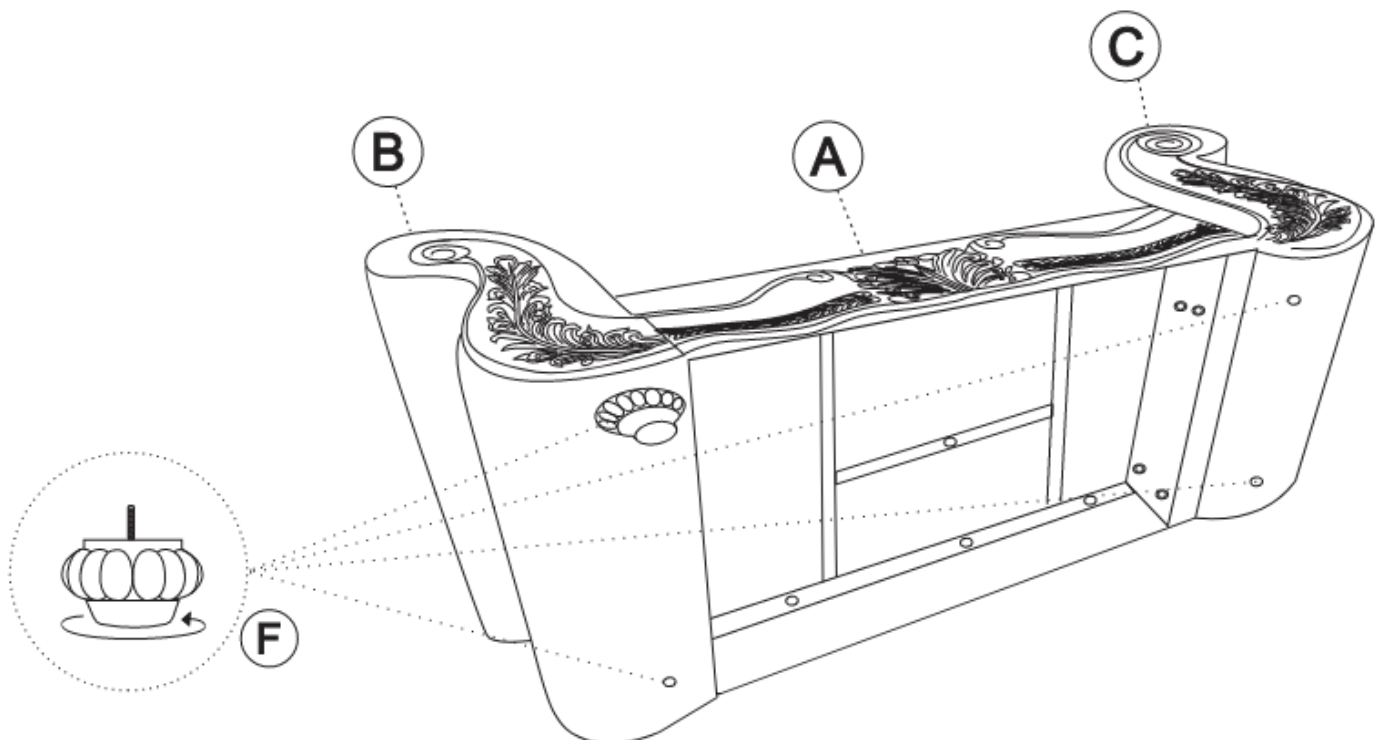

# ASSEMBLY INSTRUCTIONS

## MAXIMUS COLLECTION

U1754-30A  
U1754-30B

MAXIMUS SOFA FRAME, CUSHION, ARMS, LEGS & 5 PILLOWS  
MAXIMUS SOFA BACKREST

### STEP 3:

Place the frame up right and install the backrest (D) to the LSF arm (B) and RSF arm (C) by sliding the brackets all the way until it is secured.

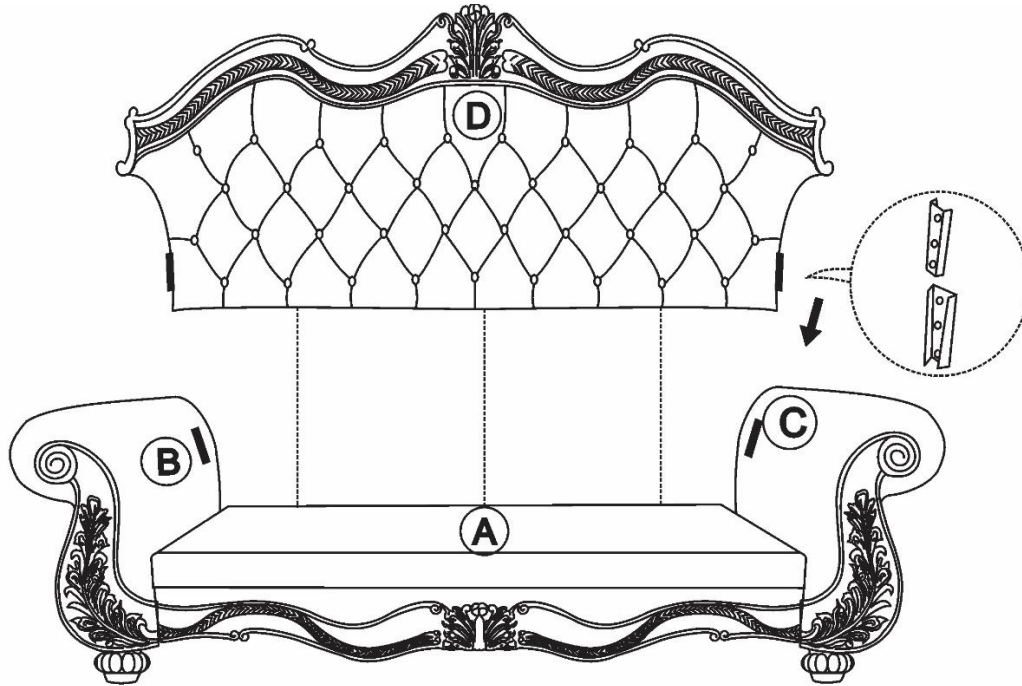

### STEP 4:

Place the chair on its back on a clean and soft surface and secure the bolts for the chair back (D) at bottom the seat frame (A) by using the Allen key (4) with hardware 1,2 and 5.

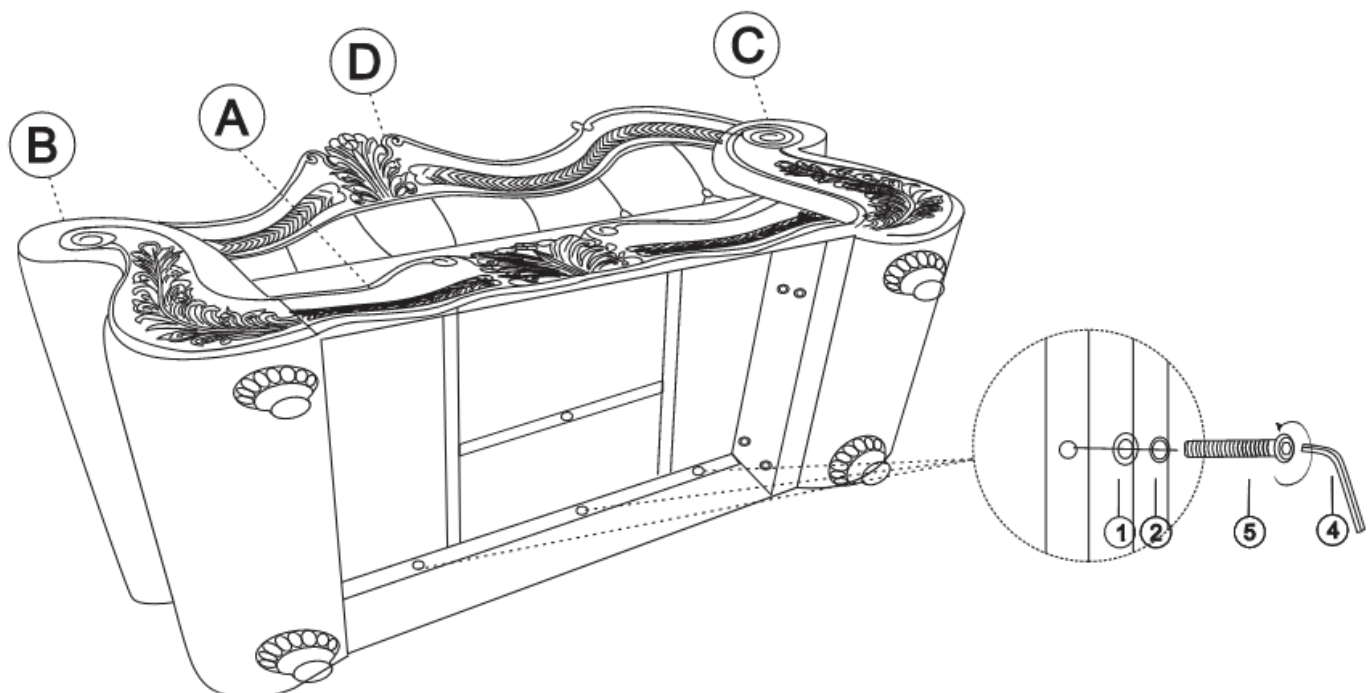

# ASSEMBLY INSTRUCTIONS

## MAXIMUS COLLECTION

U1754-30A  
U1754-30B

MAXIMUS SOFA FRAME, CUSHION, ARMS, LEGS & 5 PILLOWS  
MAXIMUS SOFA BACKREST

### STEP 5:

Screw the support leg (G) to the bottom of seat frame.

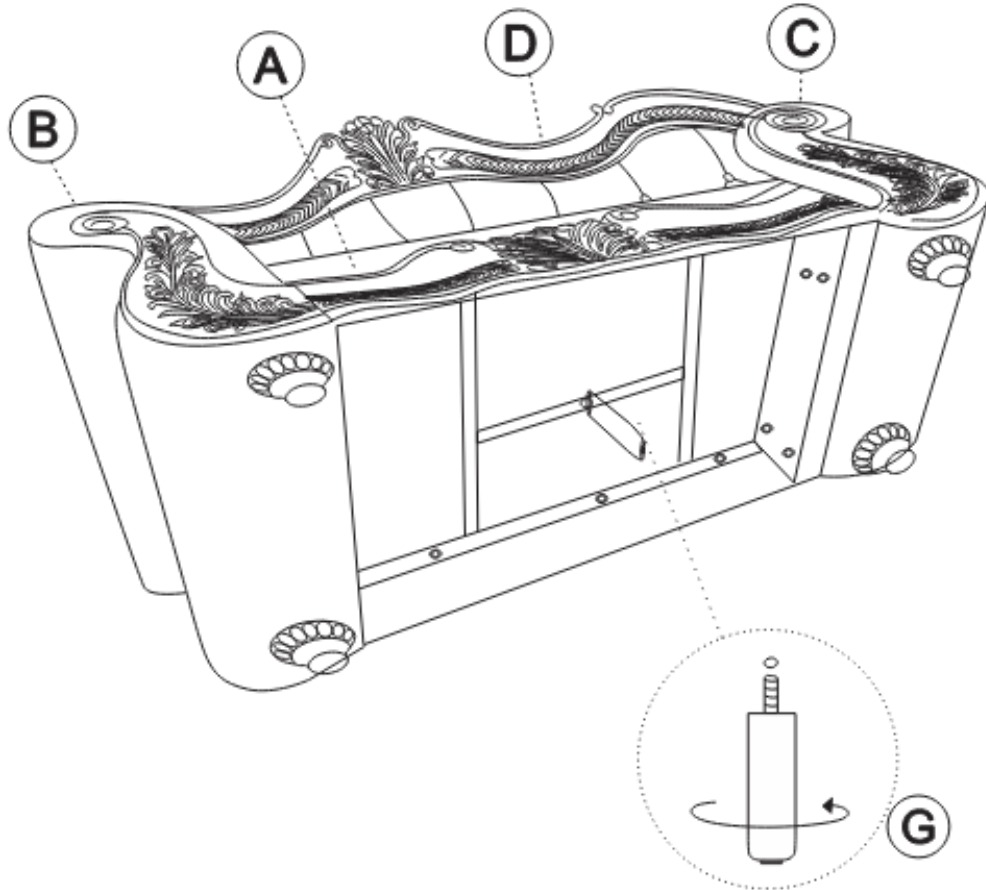

### STEP 6:

Place the frame up right and place the seat cushion (E) to the seat frame.

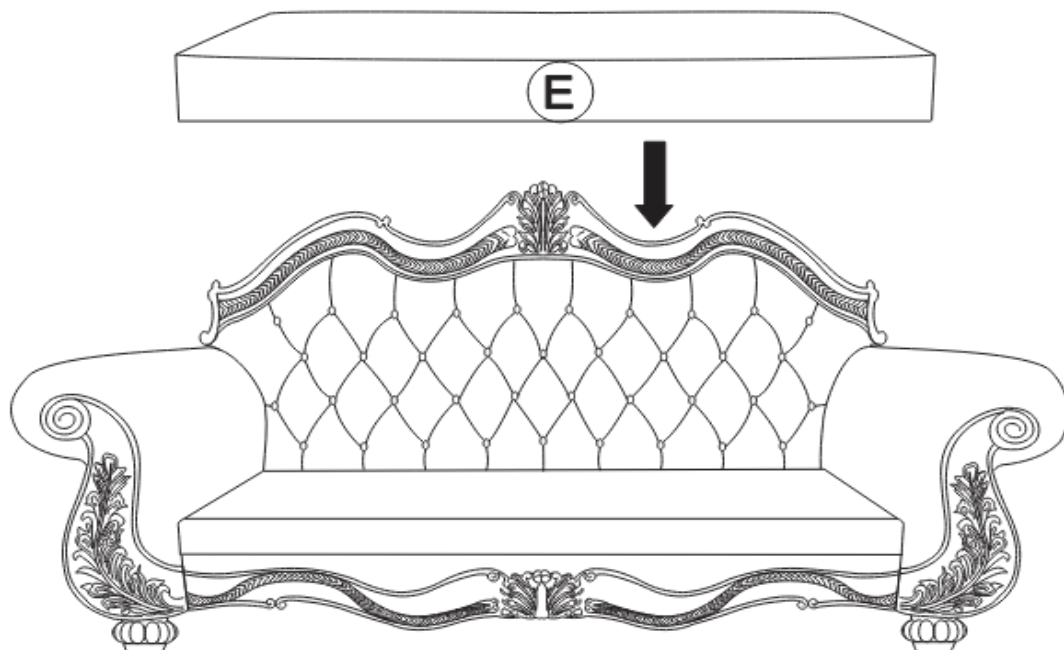

# ASSEMBLY INSTRUCTIONS

## MAXIMUS COLLECTION

U1754-30A  
U1754-30B

MAXIMUS SOFA FRAME, CUSHION, ARMS, LEGS & 5 PILLOWS  
MAXIMUS SOFA BACKREST

---

### FINISH

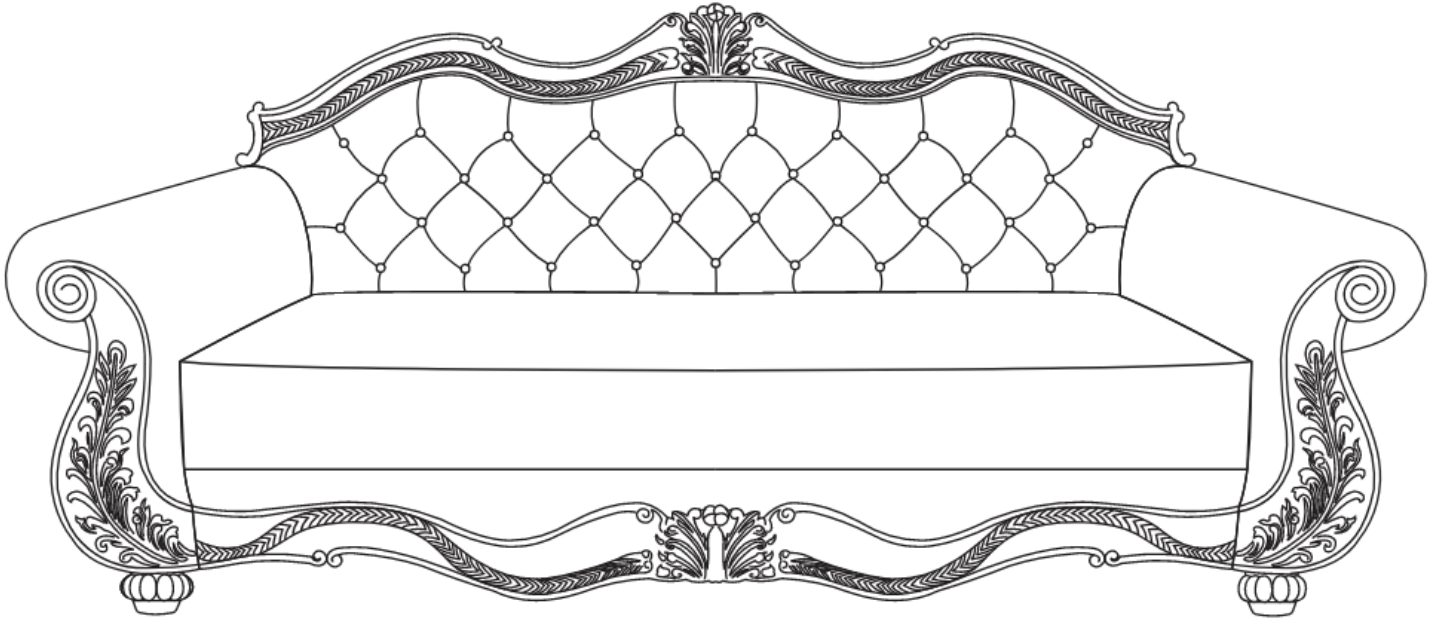

# ASSEMBLY INSTRUCTIONS

## MAXIMUS COLLECTION





U1754 -10A  
U1754 -10B



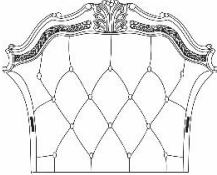
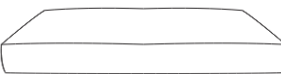

MAXIMUS CUSHION & FRAME, ARMS, AND THROW PILLOW  
MAXIMUS CHAIR BACKREST AND LEGS

Thank you for purchasing this quality product. Be sure to check all packing materials carefully for small parts, which may have come loose inside the carton during shipment. Identify and count all items and compare with the PARTS LIST and/or HARDWARE LIST shown below.

**CAUTION: Read the instructions carefully before assembly.**

1. We recommend that you assemble this product with the assistance of another person to eliminate damage to the product during assembly.
2. When you want to reposition the product, please always "LIFT & MOVE."

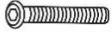
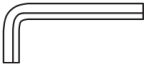
PARTS LIST			
NO.	DESCRIPTION	SKETCH	Q'TY (PCS)
A	SEAT FRAME		1
B	LEFT SIDE FACING (LSF) ARM		1
C	RIGHT SIDE FACING (RSF) ARM		1
D	BACKREST		1
E	SEAT CUSHION		1
F	LEG		4

HARDWARE LIST			
NO.	DESCRIPTION	SKETCH	Q'TY (PCS)
1	FLAT WASHER Ø5/16 x 3/4"		10
2	WASHER Ø5/16 x 1/2"		10
3	BOLT Ø5/16 x 2 1/4"		8
4	ALLEN KEY Ø5/16 x 3/4"		1
5	BOLT Ø5/16 x 3/4"		2

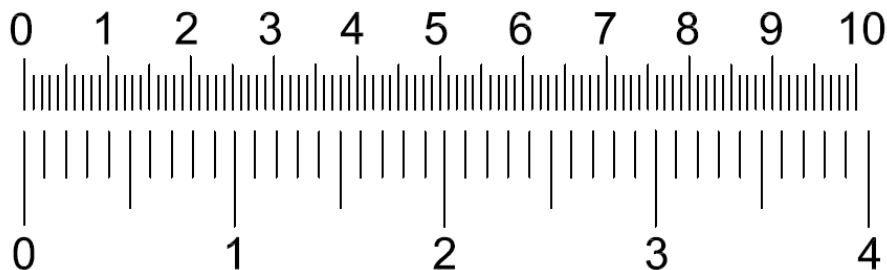

# ASSEMBLY INSTRUCTIONS

## MAXIMUS COLLECTION

U1754 -10A  
U1754 -10B

MAXIMUS CUSHION & FRAME, ARMS, AND THROW PILLOW  
MAXIMUS CHAIR BACKREST AND LEGS

### STEP 1:

Lay the seat frame (A) on its back side to reach the holes to secure the bolts for the arms. Assemble the LSF arm (B) and RSF arm (C) to the seat frame (A) using Allen Key (4) with hardware, 1, 2, and 3.

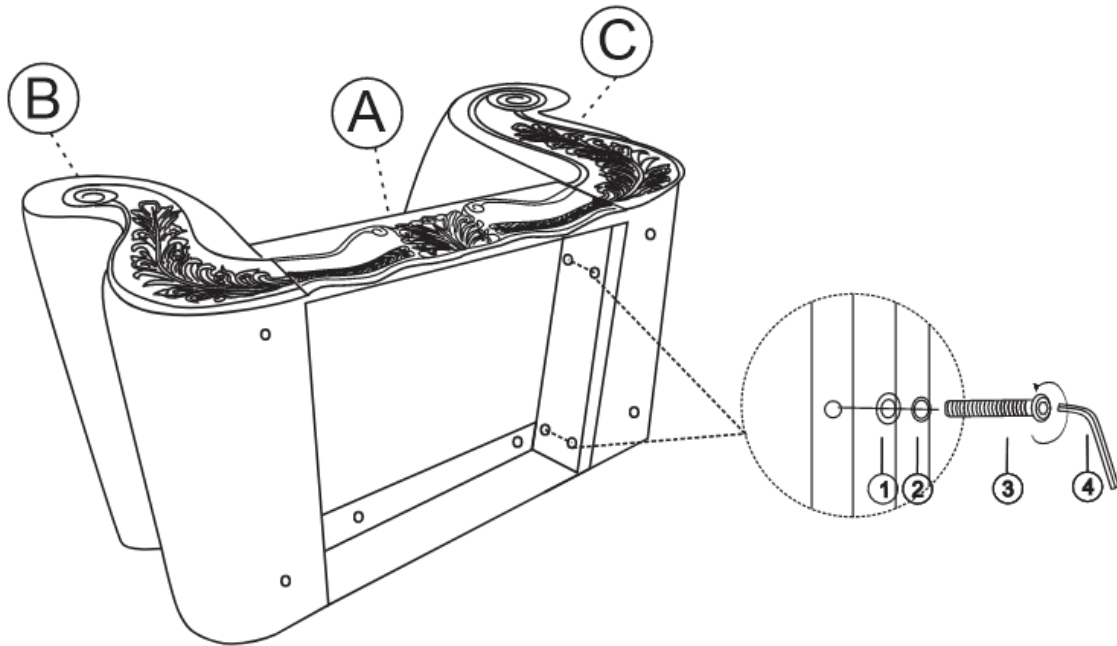

### STEP 2:

Align and install the legs (F) to the bottom of the arms (B & C)

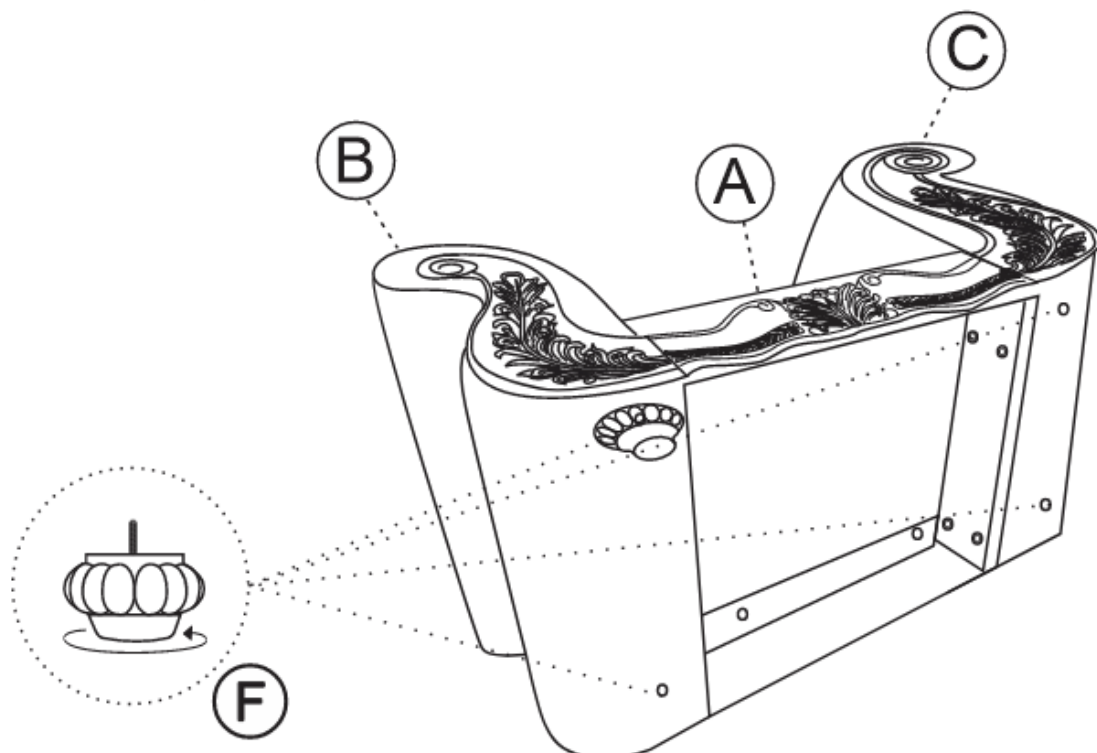

# ASSEMBLY INSTRUCTIONS

## MAXIMUS COLLECTION

U1754 -10A  
U1754 -10B

MAXIMUS CUSHION & FRAME, ARMS, AND THROW PILLOW  
MAXIMUS CHAIR BACKREST AND LEGS

### STEP 3:

Place the frame up right and install the backrest (D) to the LSF arm (B) and RSF arm (C) by sliding the brackets all the way until it is secured.

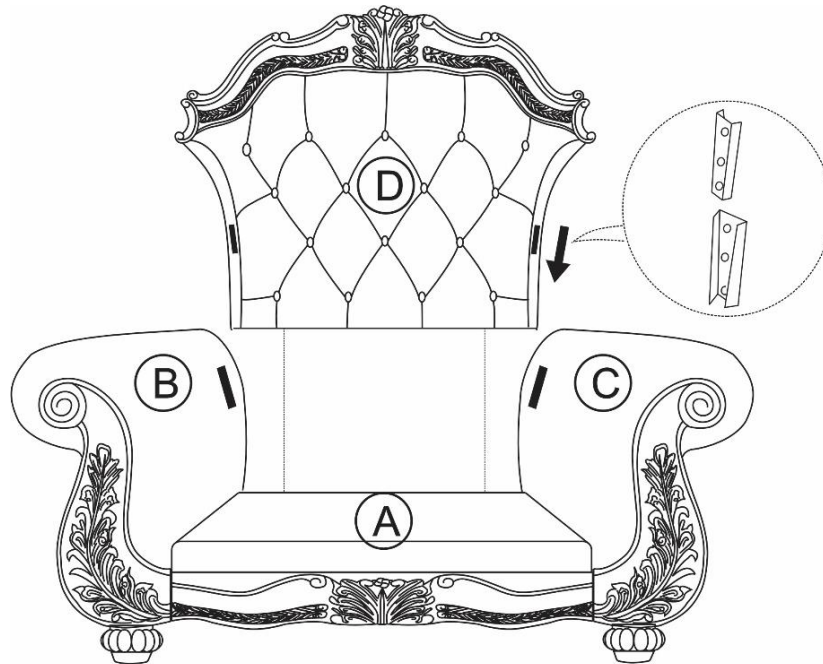

### STEP 4:

Place the chair on its back on a clean and soft surface and secure the bolts for the chair back (D) at bottom the seat frame (A) by using the Allen key (4) with hardware 1,2 and 5.

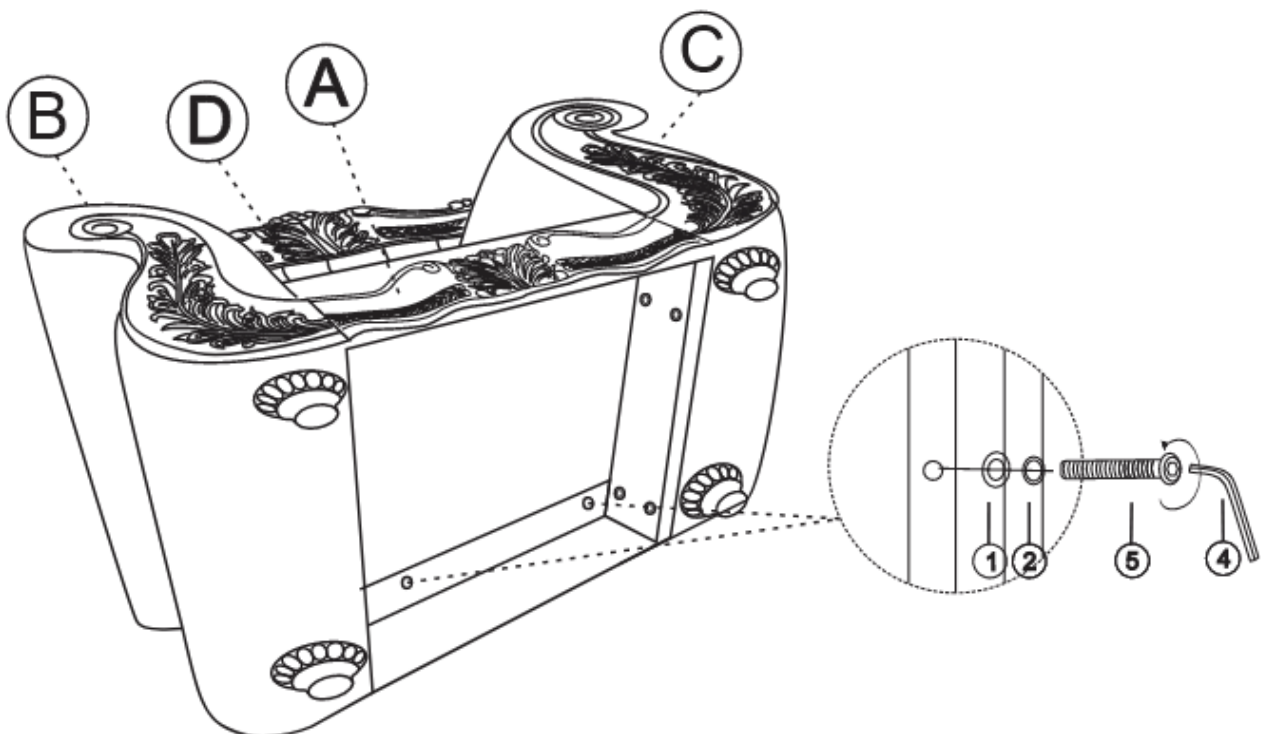

# ASSEMBLY INSTRUCTIONS

## MAXIMUS COLLECTION

U1754 -10A  
U1754 -10B

MAXIMUS CUSHION & FRAME, ARMS, AND THROW PILLOW  
MAXIMUS CHAIR BACKREST AND LEGS

---

### STEP 5:

Place the frame up right and place the seat cushion (E) to the seat frame.

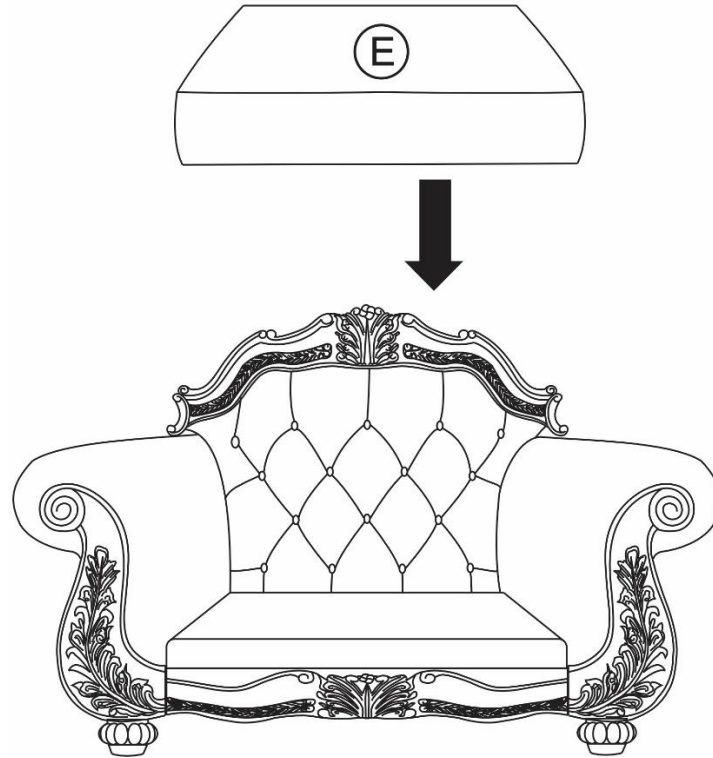

### FINISH

