

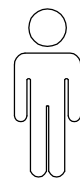

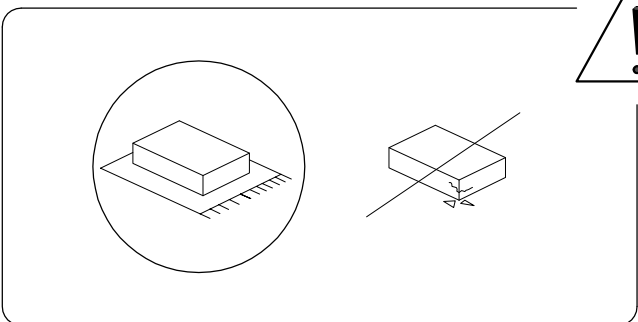





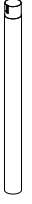
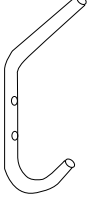
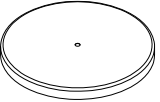
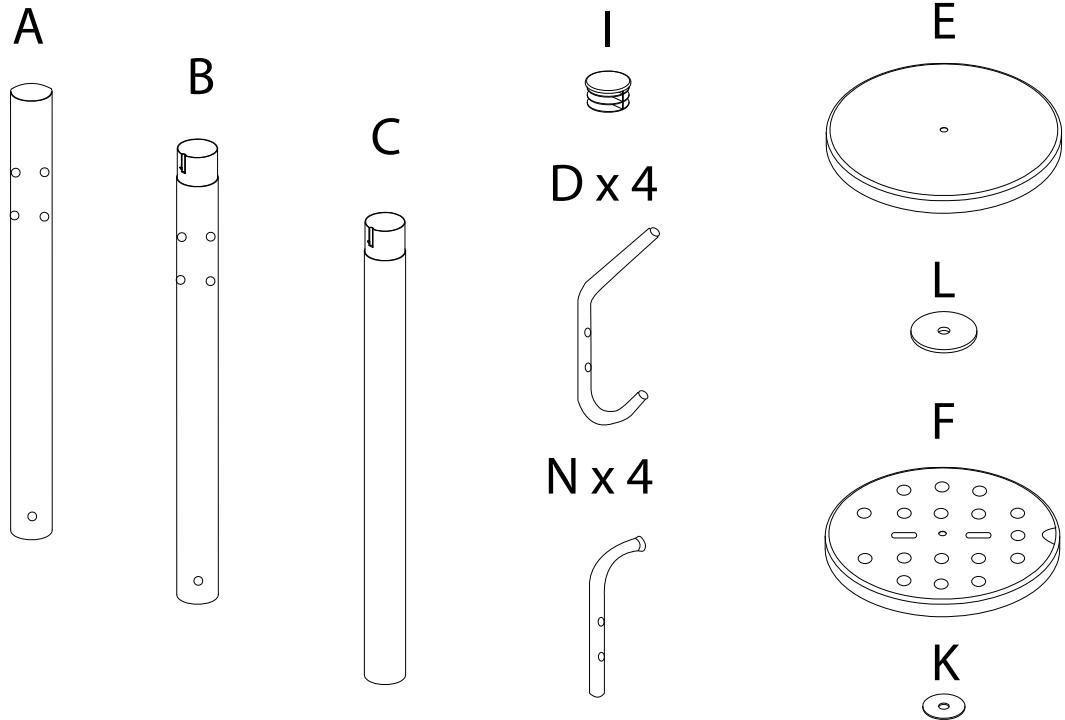

20'

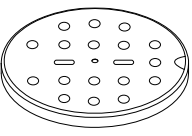
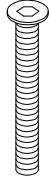
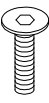

1

|   |   |   |   |   |
|---|---|---|---|---|
| <b>A</b><br><br><b>x 1</b> | <b>B</b><br><br><b>x 1</b> | <b>C</b><br><br><b>x 1</b> | <b>D</b><br><br><b>x 4</b> | <b>E</b><br><br><b>x 1</b> |
|---|---|---|---|---|

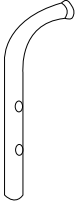

|   |   |  |   |  |
|---|---|--|---|--|
| <b>F</b><br><br><b>x 1</b> | <b>G</b><br><br><b>M8</b><br><b>x</b><br><b>32</b><br><b>x 1</b> | <b>H</b><br><br><b>M4.5</b><br><b>x</b><br><b>25</b><br><b>x 16</b> | <b>I</b><br><br><b>x 1</b> | <b>J</b><br><br><b>x 16</b> |
| <b>K</b><br><br><b>x 1</b> | <b>L</b><br><br><b>x 1</b>                                       | <b>M</b><br><br><b>x 1</b>  | <b>N</b><br><br><b>x 4</b> | <b>O</b><br><br><b>x 1</b>  |

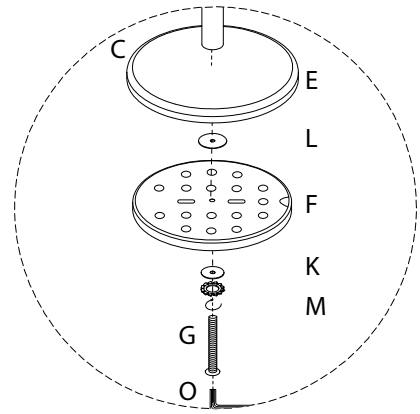
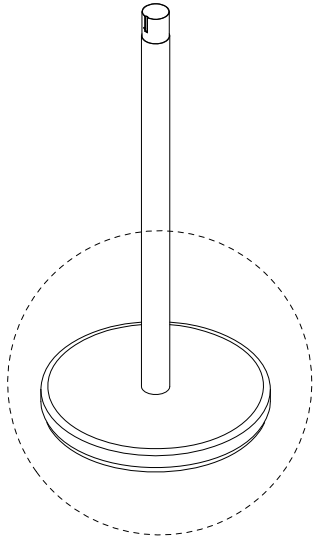
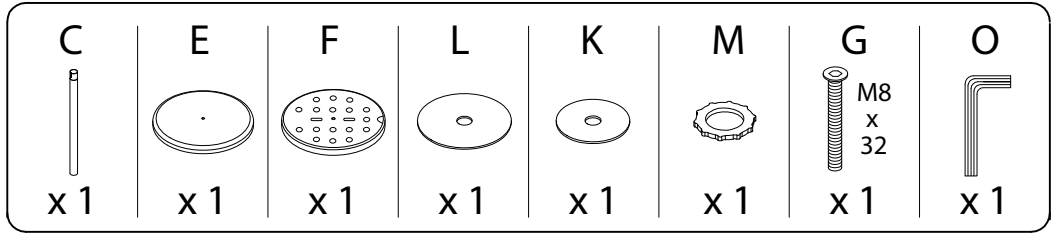

1

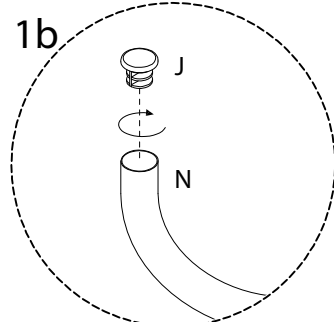
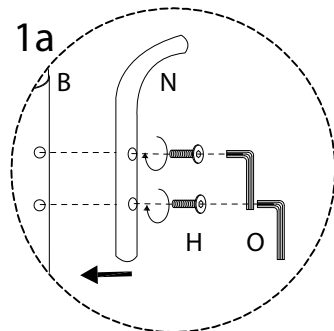
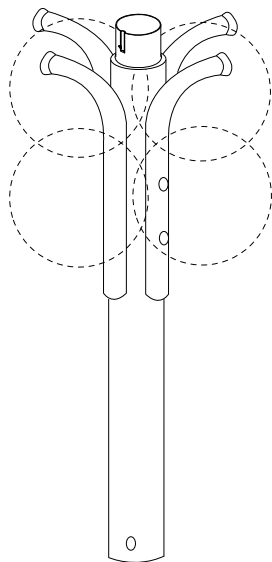
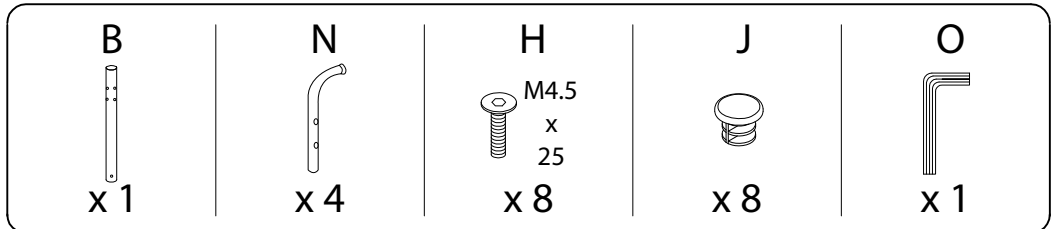

2

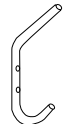

3

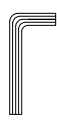
|  |  |  |  |  |
|--|--|--|--|--|
| <b>A</b><br><br>x 1 | <b>D</b><br><br>x 4 | <b>H</b><br><br>M4.5<br>x 25<br>x 8 | <b>J</b><br><br>x 8 | <b>O</b><br><br>x 1 |
|--|--|--|--|--|

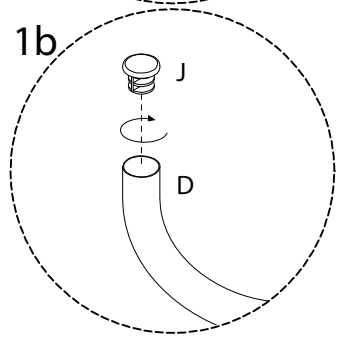
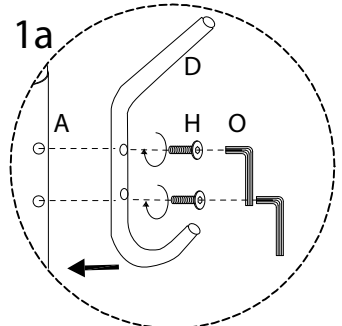
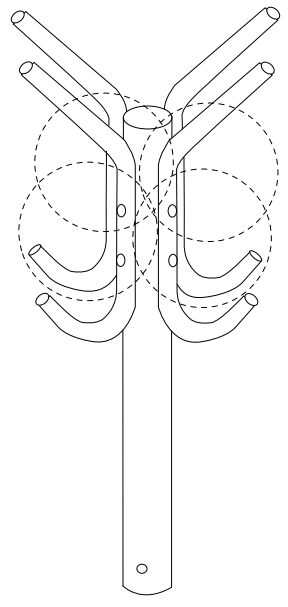

4

|  |
|--|
| <b>I</b><br><br>x 1 |
|--|

