

Outdoor Chaise Lounger

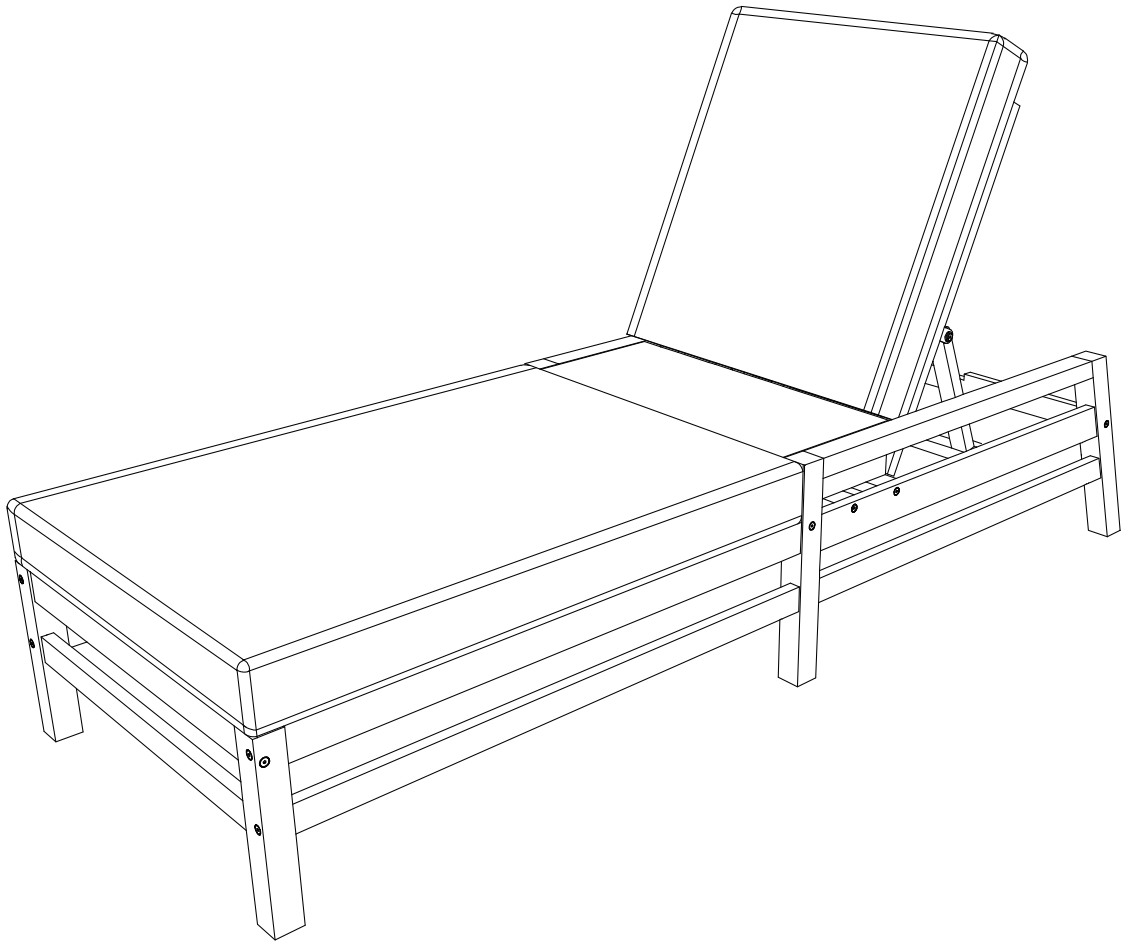

N715P404843

Please read all instructions carefully:

- 1. Have 2 adults on hand for assembly.**
- 2. 50% Tighten before fixing all screws, Allen wrench is recommended instead of an electric drill.**
- 3. Place the item on a flat ground to adjust and make sure it remains stable.**
- 4. Tighten up all screws with tools gradually.**
- 5. If the screws are not aligned with holes during assembly, please loosen all the other screws to 50% and continue the assembly process.**
- 6. If the item is not stable, please loosen all the screws, adjust it on a flat ground and tighten up all screws again.**
- 7. Note : If one or some screws are fully tightened during assembly, chances are the others will not be aligned with holes. In addition, all the holes are designed to be relatively larger to provide more space for the adjustment of the screws.**

Assembly Instruction

Caution: You must read these Assembly Instructions before you proceed.



SAFETY WARNING

Never adjust chaise lounge or recliner backrest while seated.

Always make sure the backrest is flat before moving the chaise lounge.





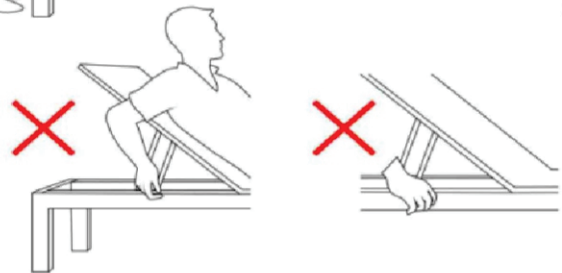
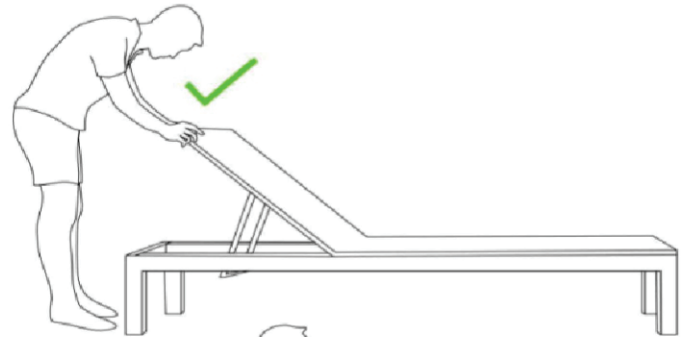



Keep all limbs clear from under the backrest when it is in a raised position.

Serious finger, hand, or other bodily injuries may result from adjusting the chaise lounge backrest position while seated.









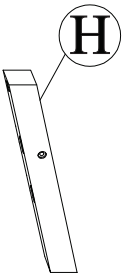
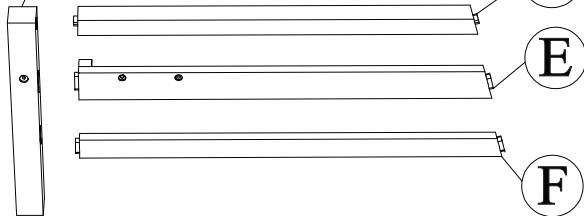
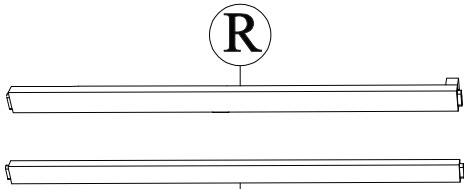
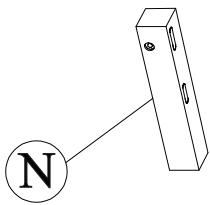
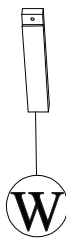
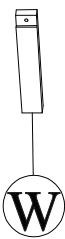
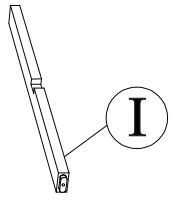
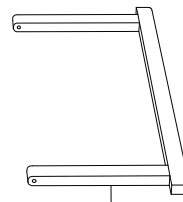
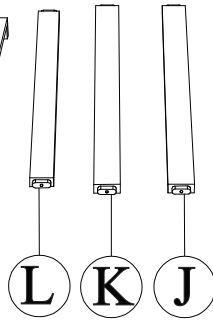
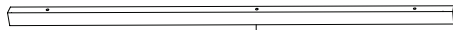
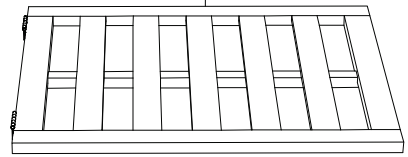
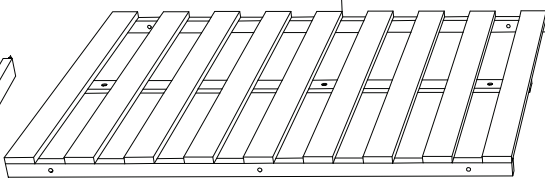
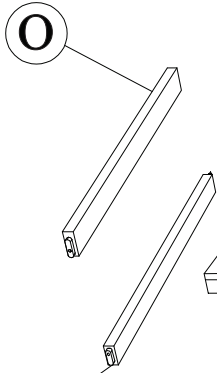
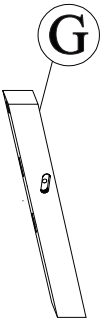
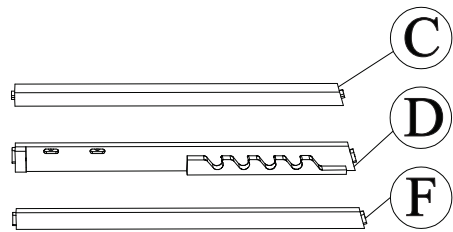
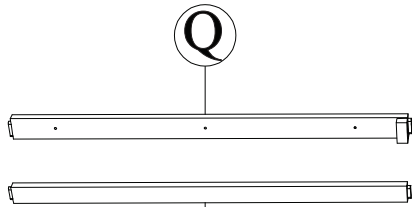
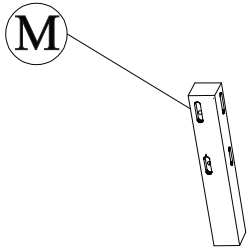
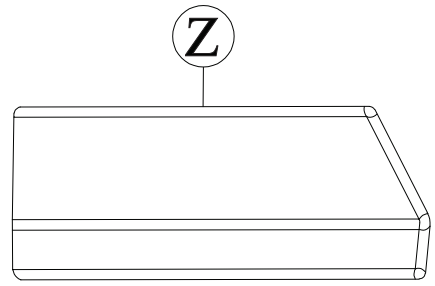
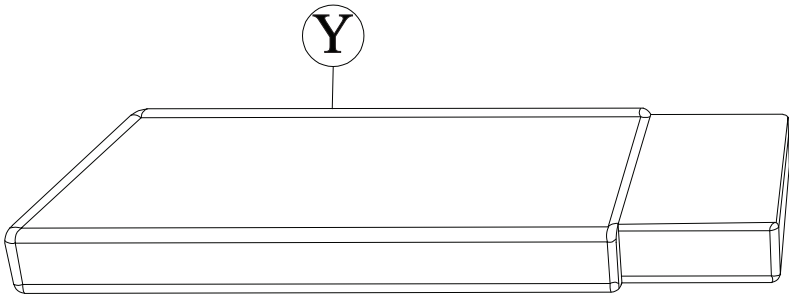

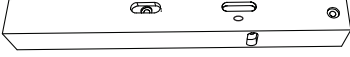
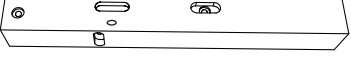

The examples pictured above are non exhaustive and are for your reference only

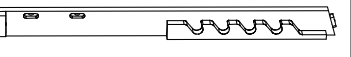
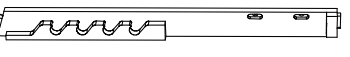
Care & Maintenance

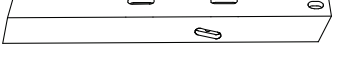
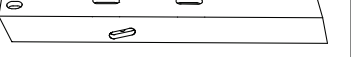
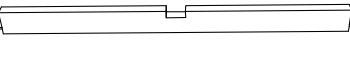
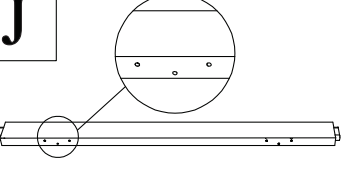
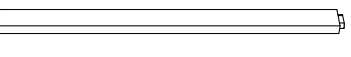
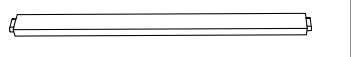

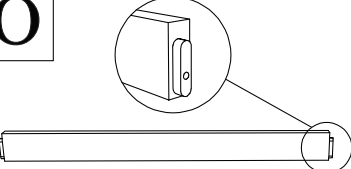
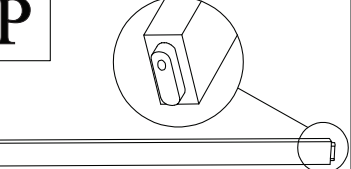
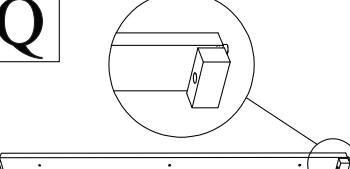
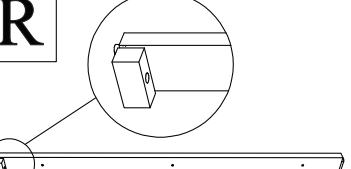
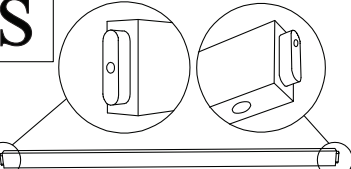
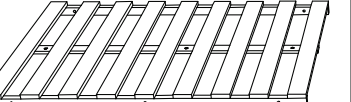
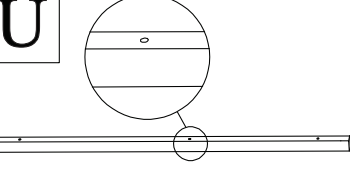
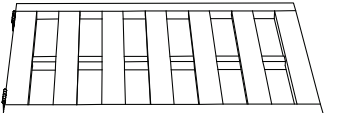

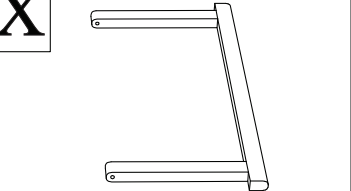

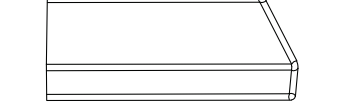
- ⊘  • Not for commercial use. For residential use only
- ⊘  • Do not put hot items directly on furniture surface.
- ⊘  • Do not clean furniture with harsh cleansers or polish.
- ✓  • To obtain the longest lifespan of your outdoor products, minimizing exposure to direct sunlight is recommended.
- ⊘  • Children should not climb or jump on the furniture.
- ⊘  • Do not write on furniture without a padded barrier to protect the surface.
- ✓  • To obtain the longest lifespan of your outdoor products, avoid extended and lengthy exposure to rain, snow, and direct sunshine. Whenever possible cover the product and /or place under patio or awnings.
- ⊘  • Stains may be removed with mild soap solution and damp cloth..
- ✓  • Dust and pick-up spills using a clean, non-colored, lint-free cloth.



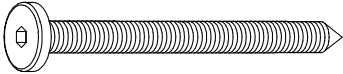

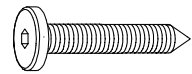
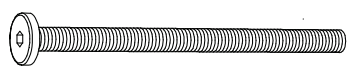
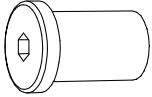
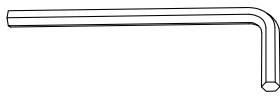

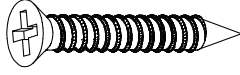
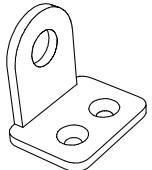
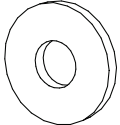
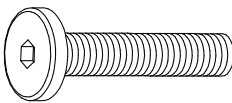
Part List :

<p>A</p>  <p>Left Middle Leg (1pc)</p>	<p>B</p>  <p>Right Middle Leg (1pc)</p>	<p>C</p>  <p>Armrest (2pcs)</p>	<p>D</p>  <p>Left Middle Rail (1pc)</p>
<p>E</p>  <p>Right Middle Rail (1pc)</p>	<p>F</p>  <p>First Leg Support Bar(2pcs)</p>	<p>G</p>  <p>Left Back Leg (1pc)</p>	<p>H</p>  <p>Right Back Leg (1pc)</p>
<p>I</p>  <p>Backrest Bar (1pc)</p>	<p>J</p>  <p>First Cross Bar (1pc)</p>	<p>K</p>  <p>Second Cross Bar (1pc)</p>	<p>L</p>  <p>Third Cross Bar (1pc)</p>
<p>M</p>  <p>Left Front Leg (1pc)</p>	<p>N</p>  <p>Right Front Leg (1pc)</p>	<p>O</p>  <p>Front Rail (1pc)</p>	<p>P</p>  <p>Front Leg Support Bar (1pc)</p>
<p>Q</p>  <p>Left Side Rail (1pc)</p>	<p>R</p>  <p>Right Side Rail (1pc)</p>	<p>S</p>  <p>Second Leg Support Bar(2pcs)</p>	<p>T</p>  <p>Seat Frame (1pc)</p>
<p>U</p>  <p>Seat Support Bar (1pc)</p>	<p>V</p>  <p>Backrest Panel (1pc)</p>	<p>W</p>  <p>Support Leg (2pcs)</p>	<p>X</p>  <p>Lifting Bar(1pc)</p>
<p>Y</p>  <p>Seat Cushion (1pc)</p>	<p>Z</p>  <p>Back Cushion (1pc)</p>		

Hardware List :

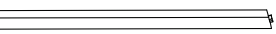

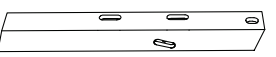
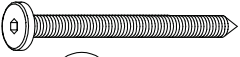

<p>1</p>  <p>Screw M6*70 (12pcs) (Extra 1pc)</p>	<p>2</p>  <p>Screw M6*55 (16pcs) (Extra 1pc)</p>	<p>3</p>  <p>Screw M6*35 (8pcs) (Extra 1pc)</p>	<p>4</p>  <p>Bolt M6*90 (2pcs) (Extra 1pc)</p>
<p>5</p>  <p>Sleeve Nut M6*15 (4pcs) (Extra 1pc)</p>	<p>6</p>  <p>Allen Wrench (2pcs)</p>	<p>7</p>  <p>Screw M4*15 (4pcs) (Extra 1pc)</p>	<p>8</p>  <p>Screw M4*25 (3pcs) (Extra 1pc)</p>
<p>9</p>  <p>Metal Bracket (2pcs)</p>	<p>10</p>  <p>Flat Washer M6 (2pcs) (Extra 1pc)</p>	<p>11</p>  <p>Bolt M6*35 (2pcs) (Extra 1pc)</p>	<p>12</p>  <p>Screw M3.5*15 (6pcs) (Extra 1pc)</p>

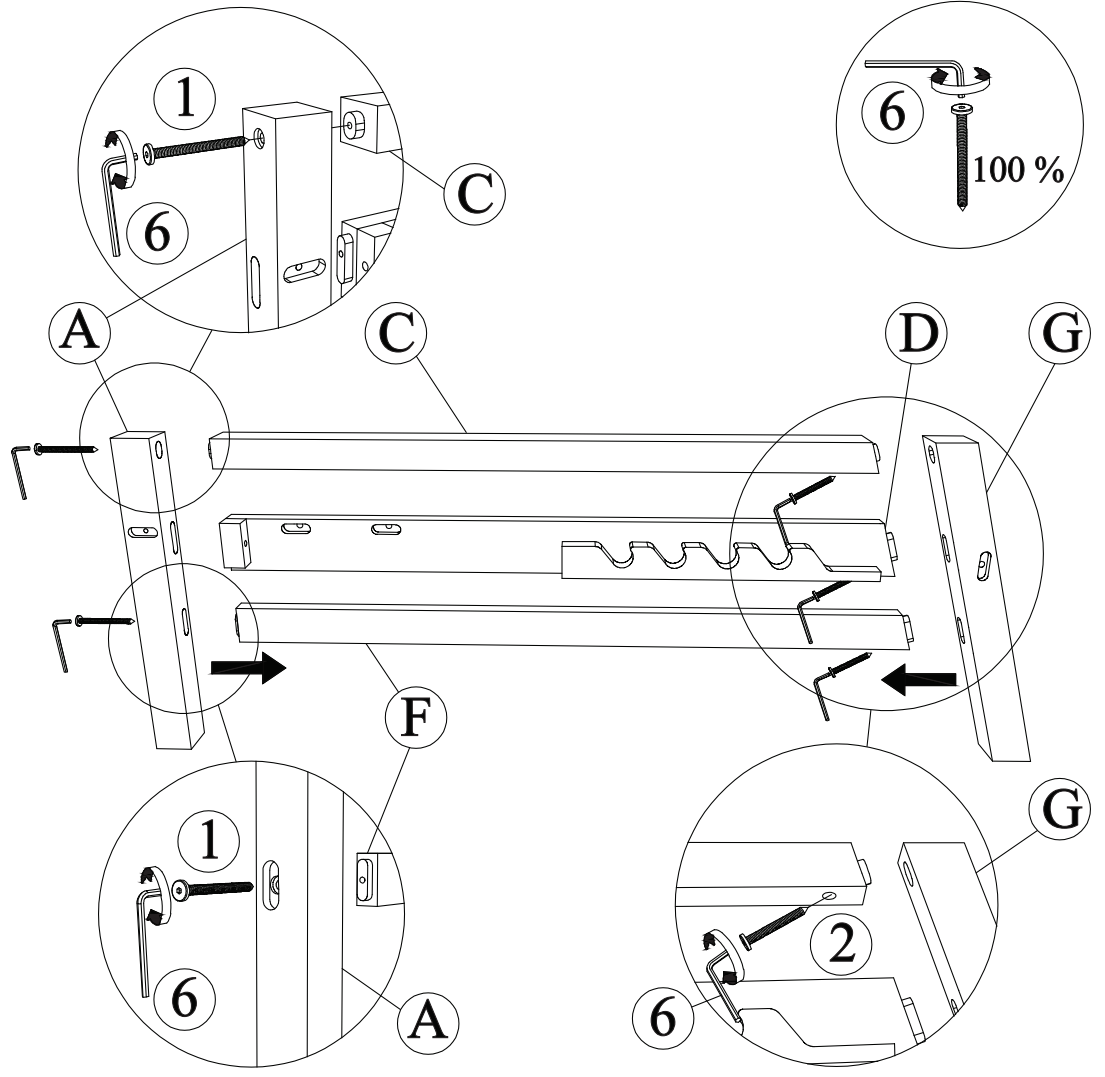
STEP 1

-  **A** x 1
-  **C** x 1
-  **D** x 1
-  **F** x 1
-  **G** x 1
-  **1** x 2
-  **2** x 3
-  **6** x 1

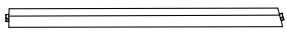
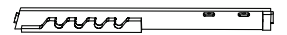

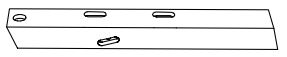
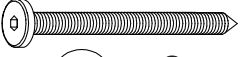

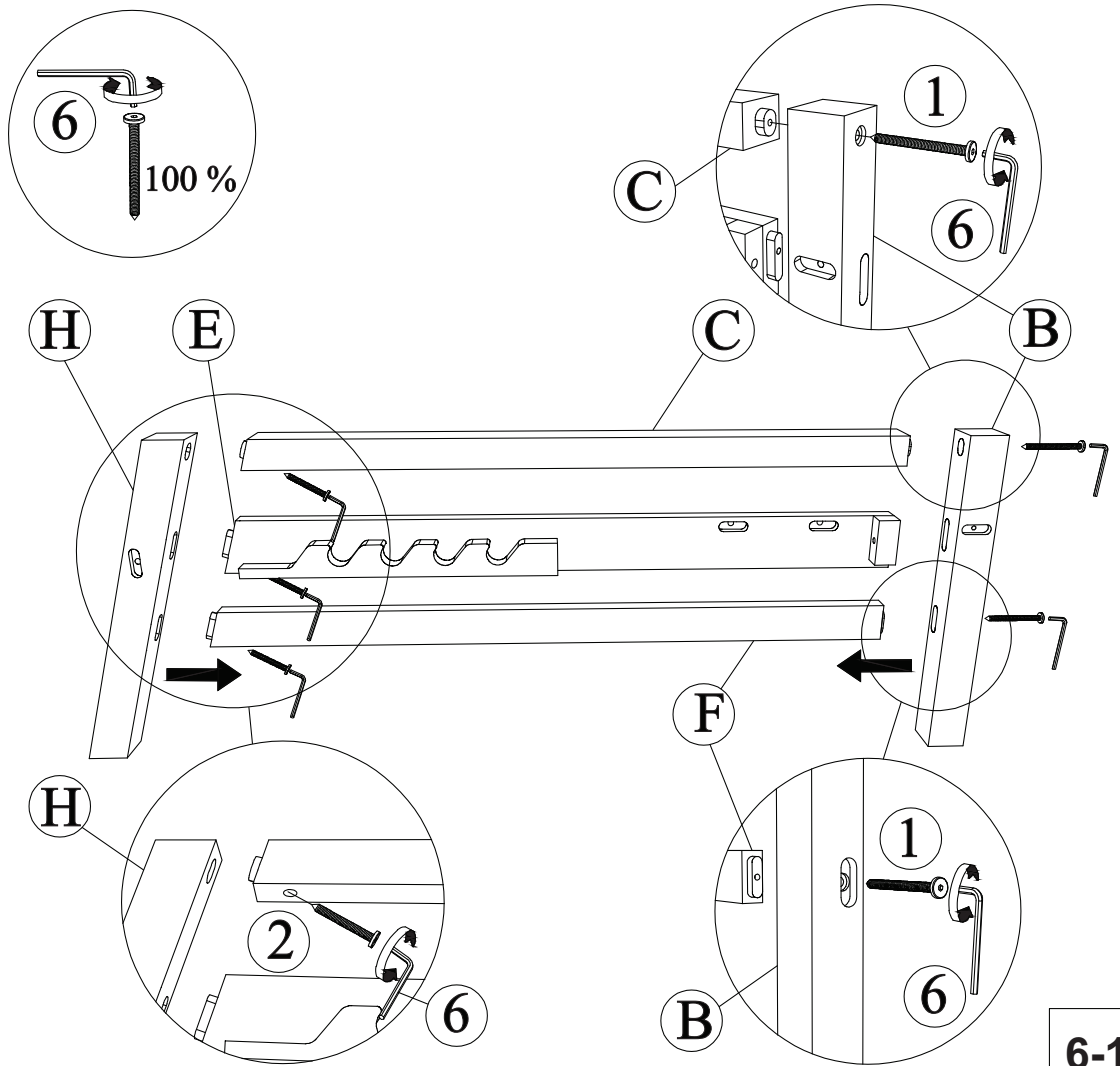

STEP 2

-  **B** x 1
-  **C** x 1
-  **E** x 1
-  **F** x 1
-  **H** x 1
-  **1** x 2
-  **2** x 3
-  **6** x 1

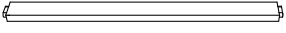
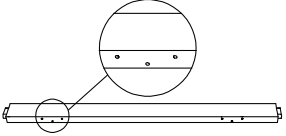

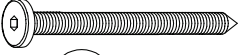

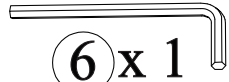

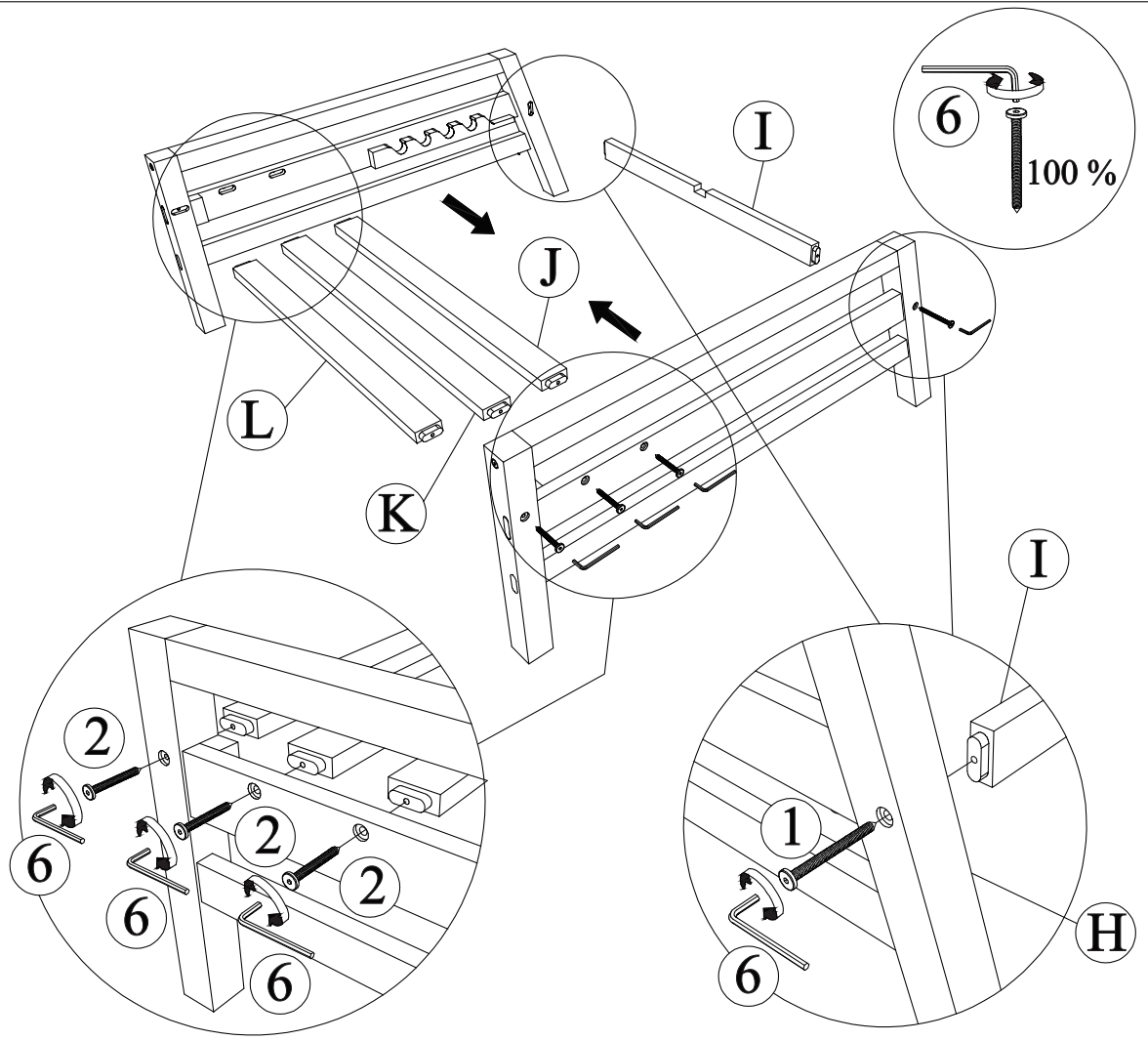
STEP 3

-  **L x 1**
-  **K x 1**
-  **J x 1**
-  **I x 1**
-  **1 x 2**
-  **2 x 6**
-  **6 x 1**

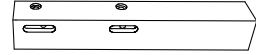
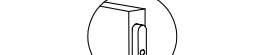

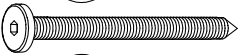

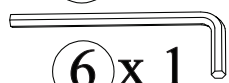

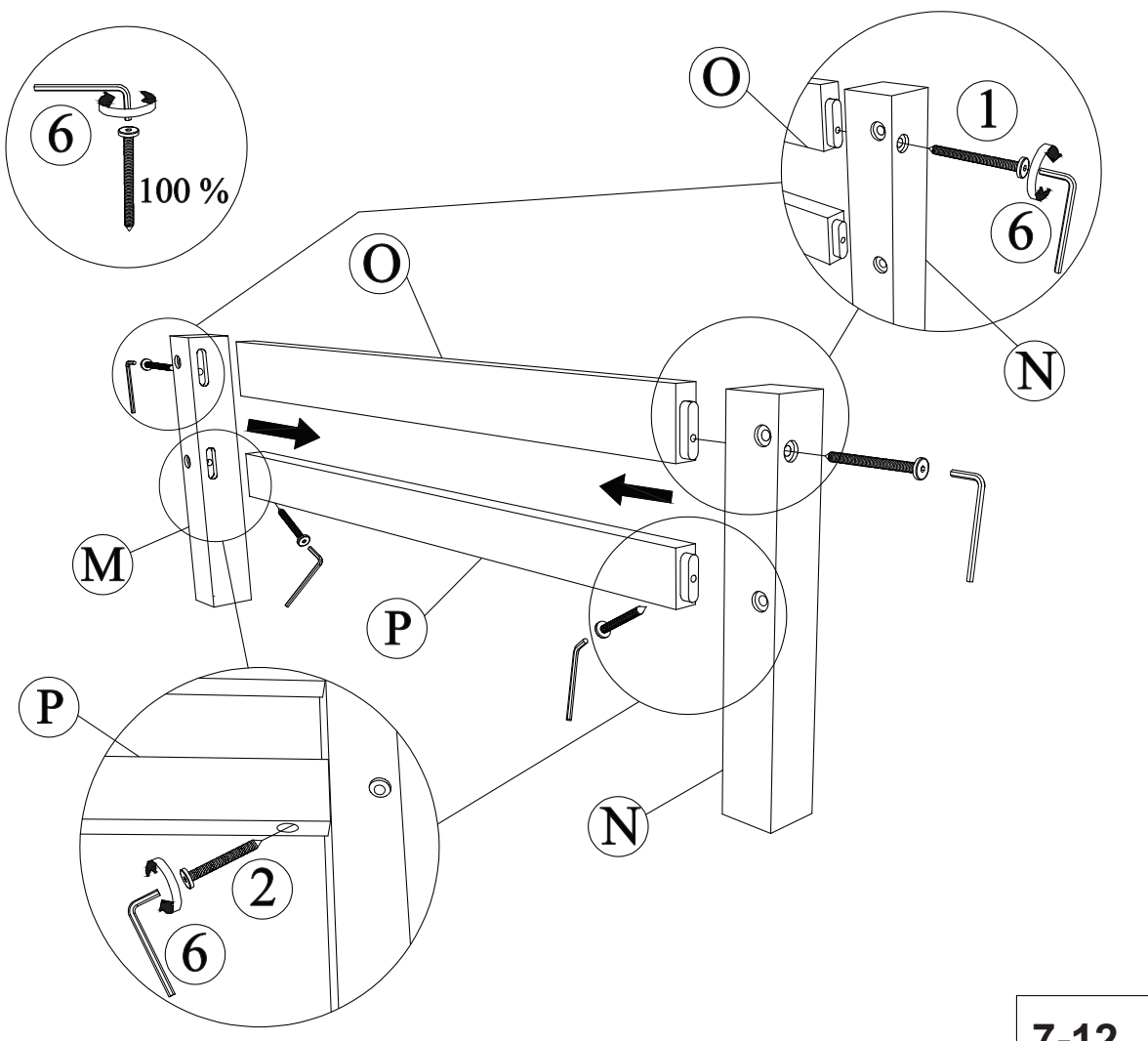
STEP 4

-  **M x 1**
-  **N x 1**
-  **O x 1**
-  **P x 1**
-  **1 x 2**
-  **2 x 2**
-  **6 x 1**

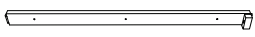
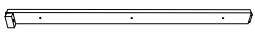
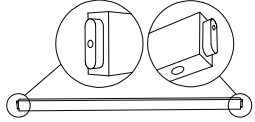

STEP 5

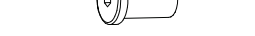
-  **Q** x 1
-  **R** x 1
-  **S** x 2
-  **1** x 4
-  **2** x 2
-  **6** x 2
-  **4** x 2
-  **5** x 2

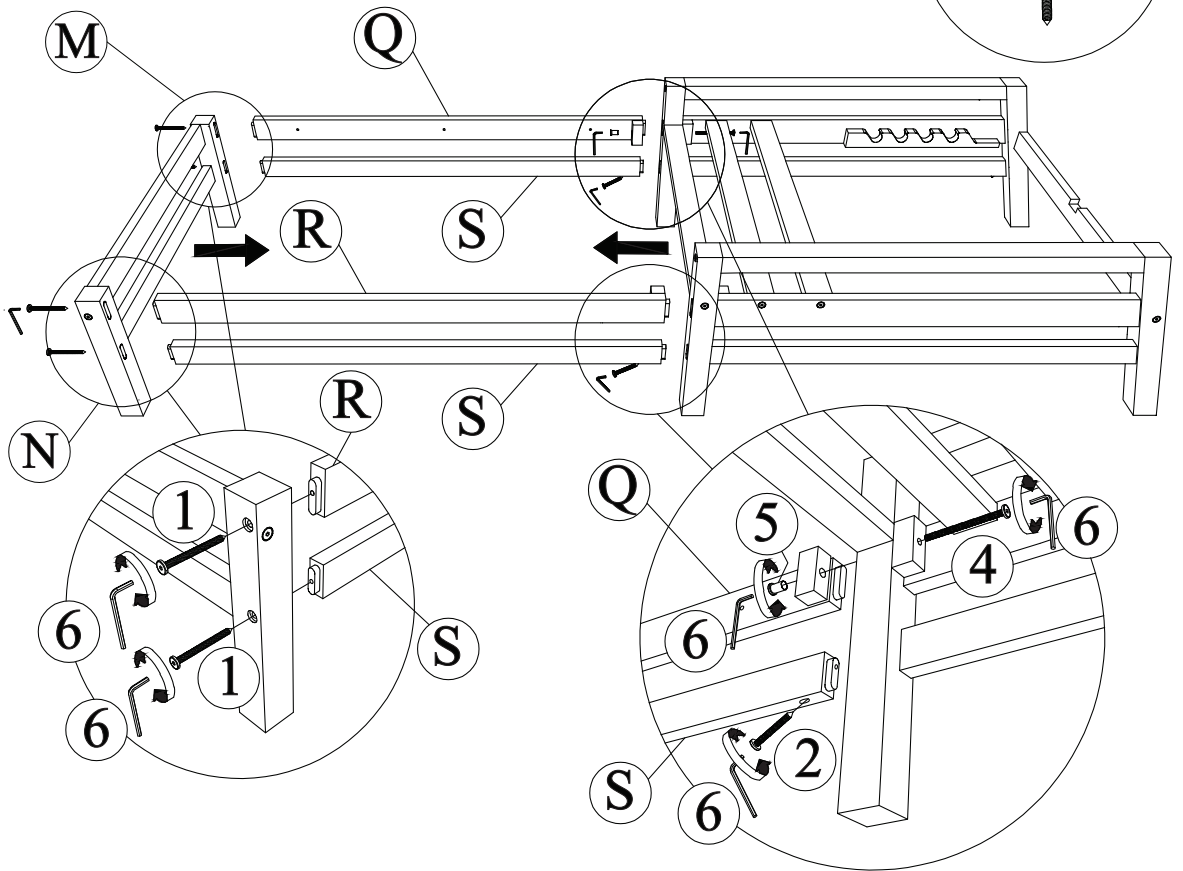

STEP 6

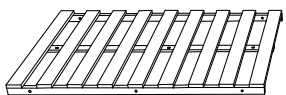
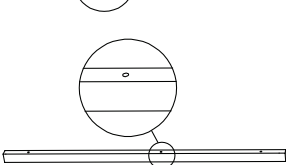
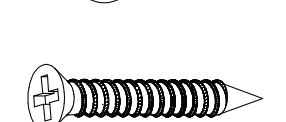
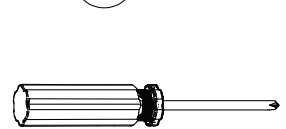
-  **T** x 1
-  **U** x 1
-  **8** x 3
- 

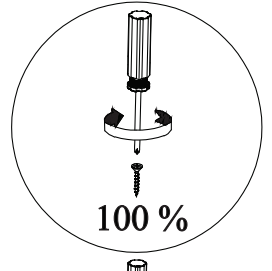
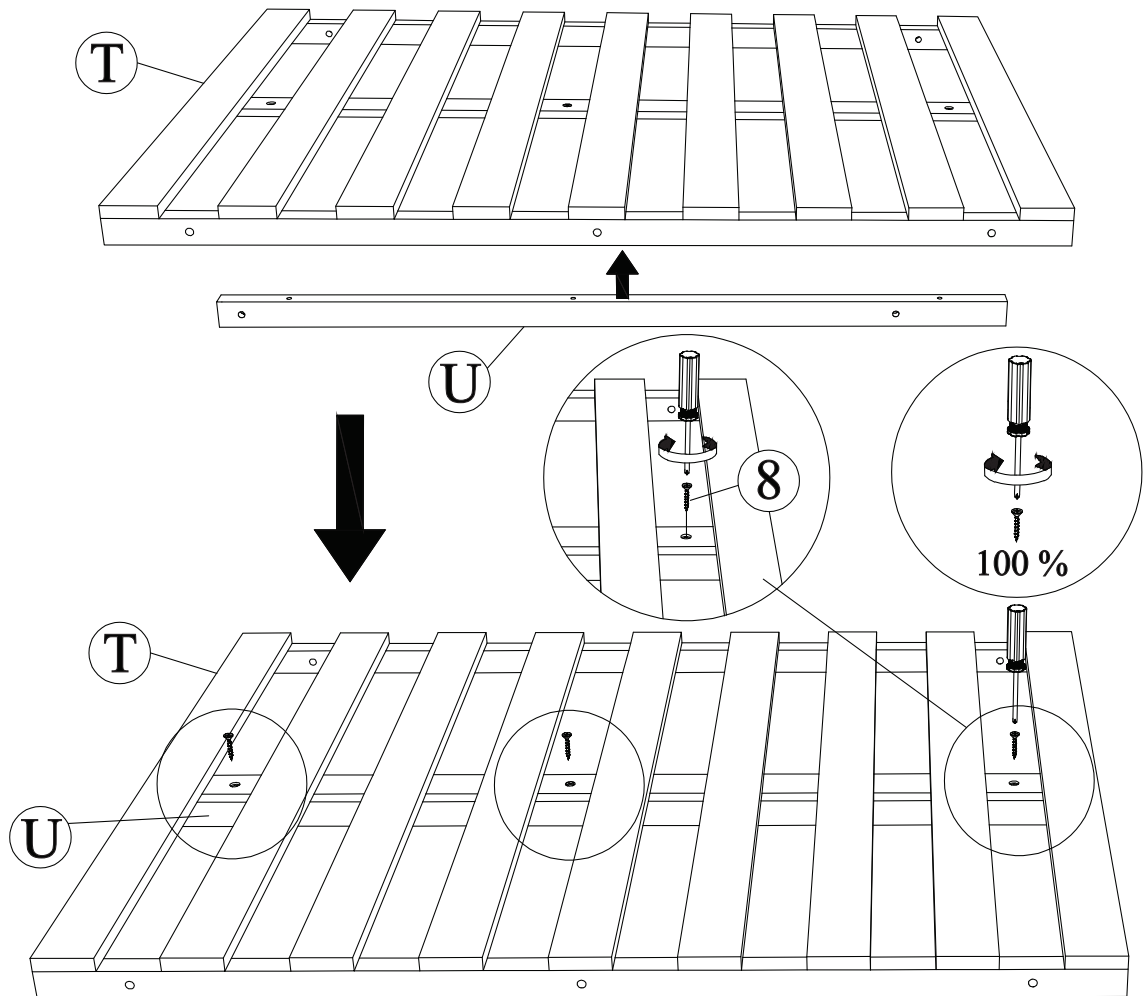

STEP 7

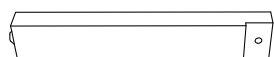
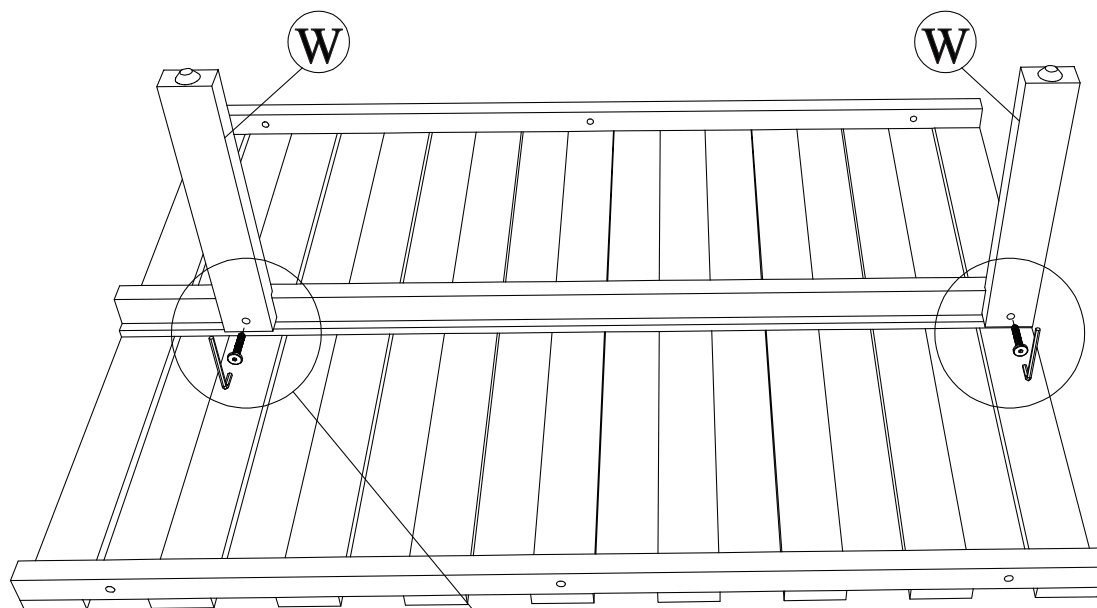

W x 2

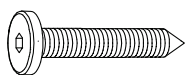

3 x 2

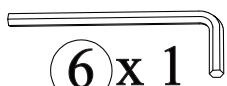

6 x 1

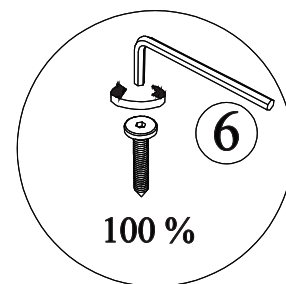
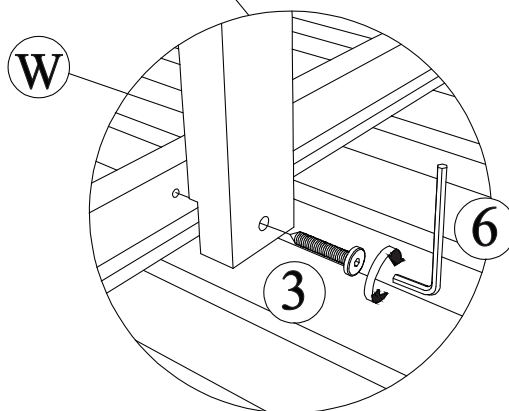

STEP 8

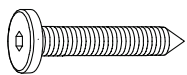
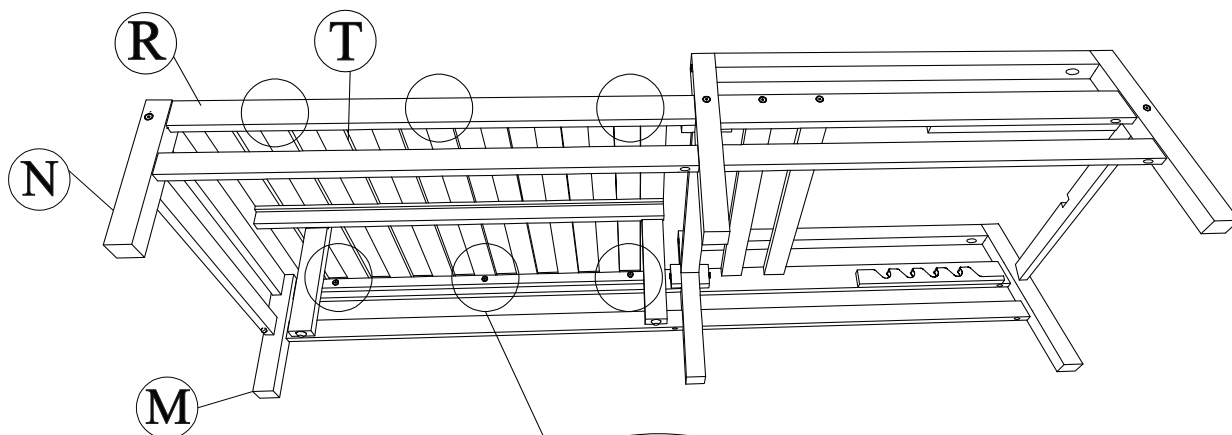

3 x 6

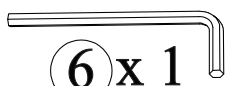

6 x 1

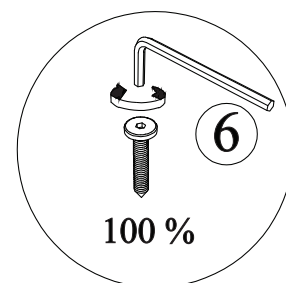
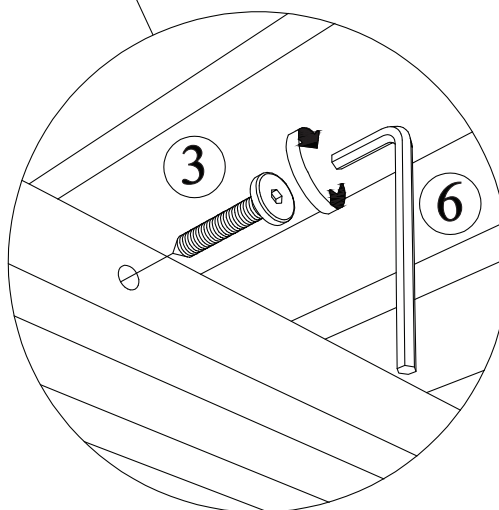

STEP 9

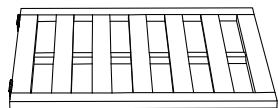

V x 1

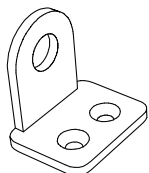

9 x 2



7 x 4

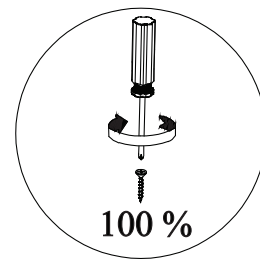
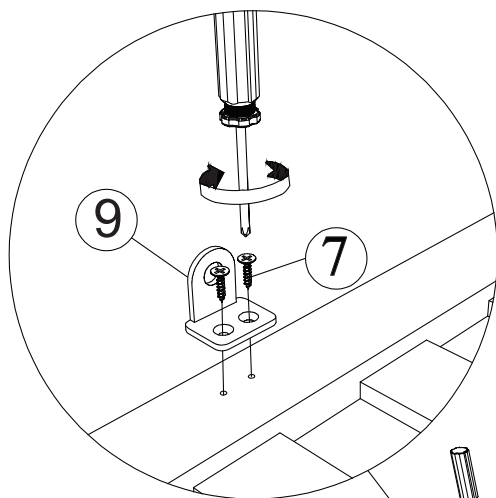

V

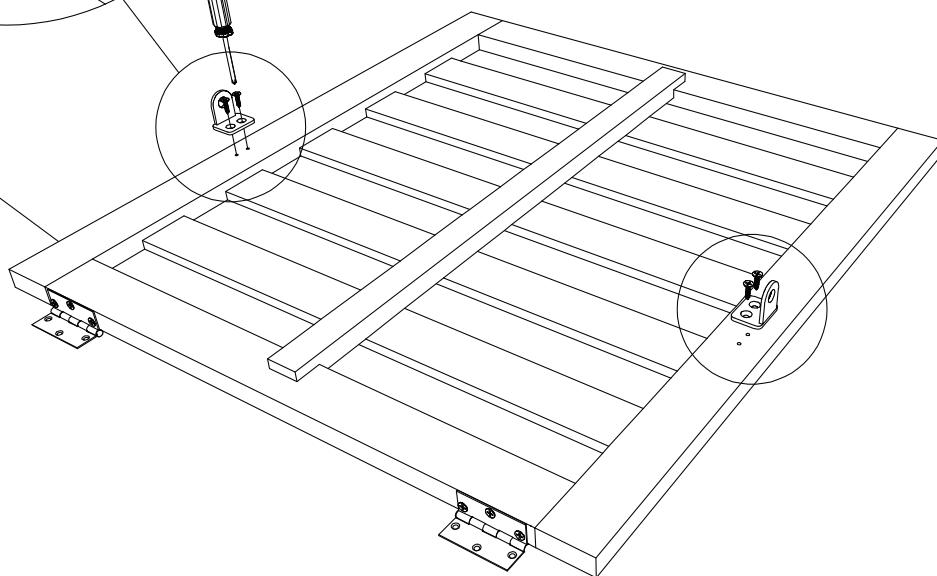

STEP 10

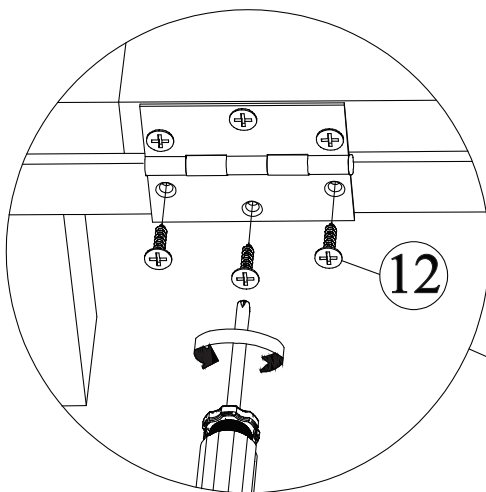

V

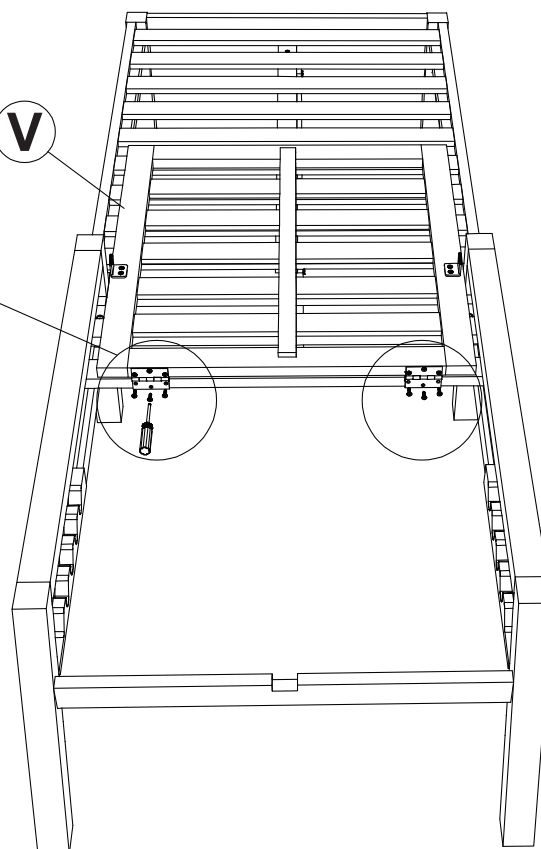

12 x 6

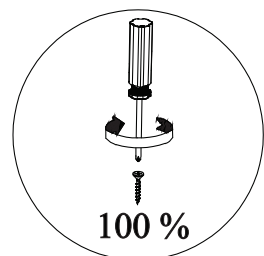

STEP 11

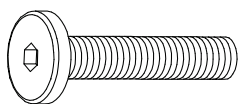

11 x 2

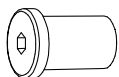

5 x 2

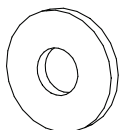

10 x 2



6 x 2

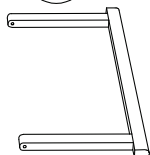

X x 1

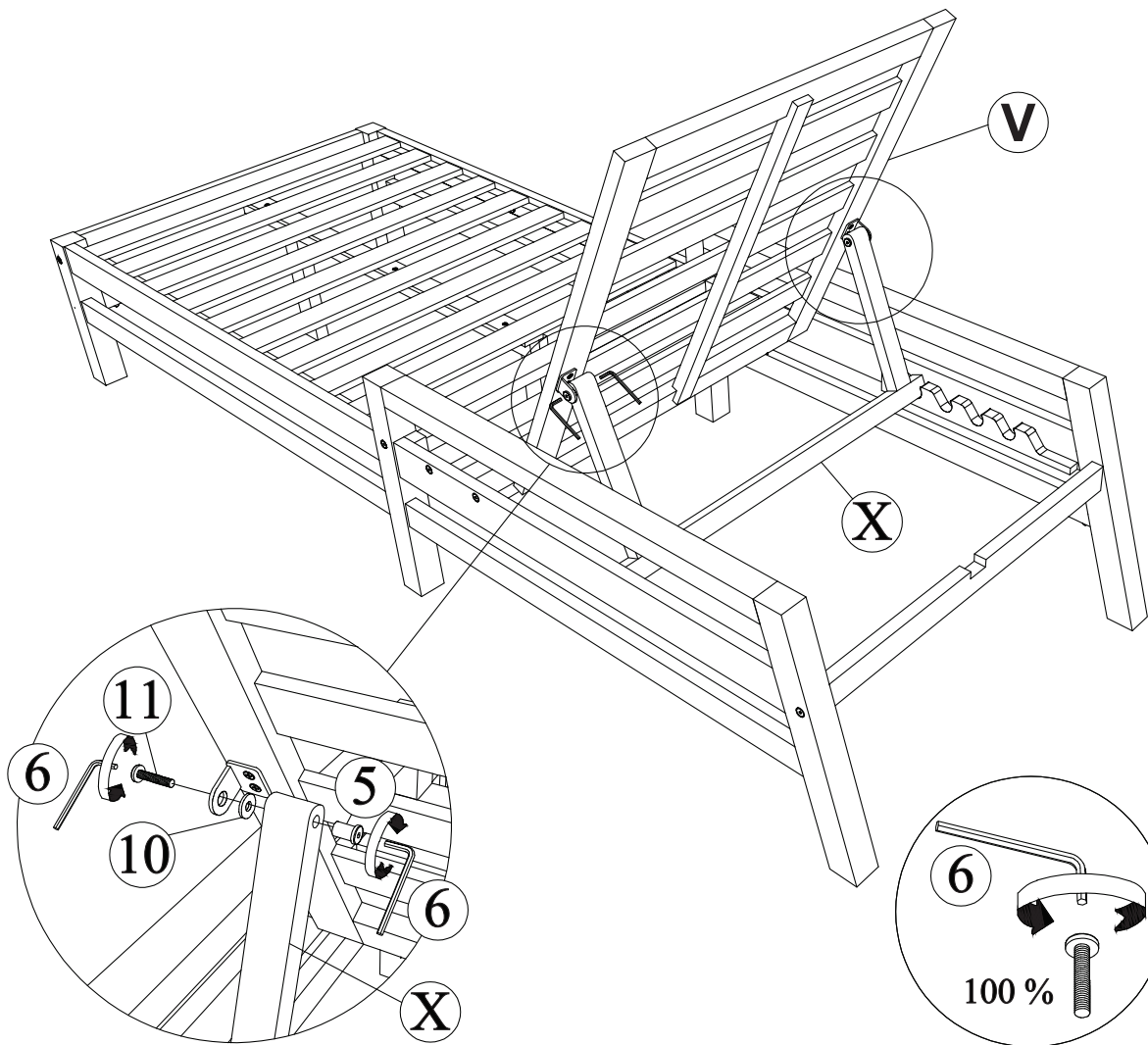

STEP 12

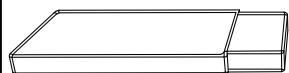

Y x 1

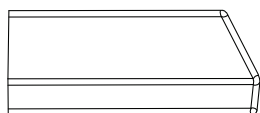

Z x 1

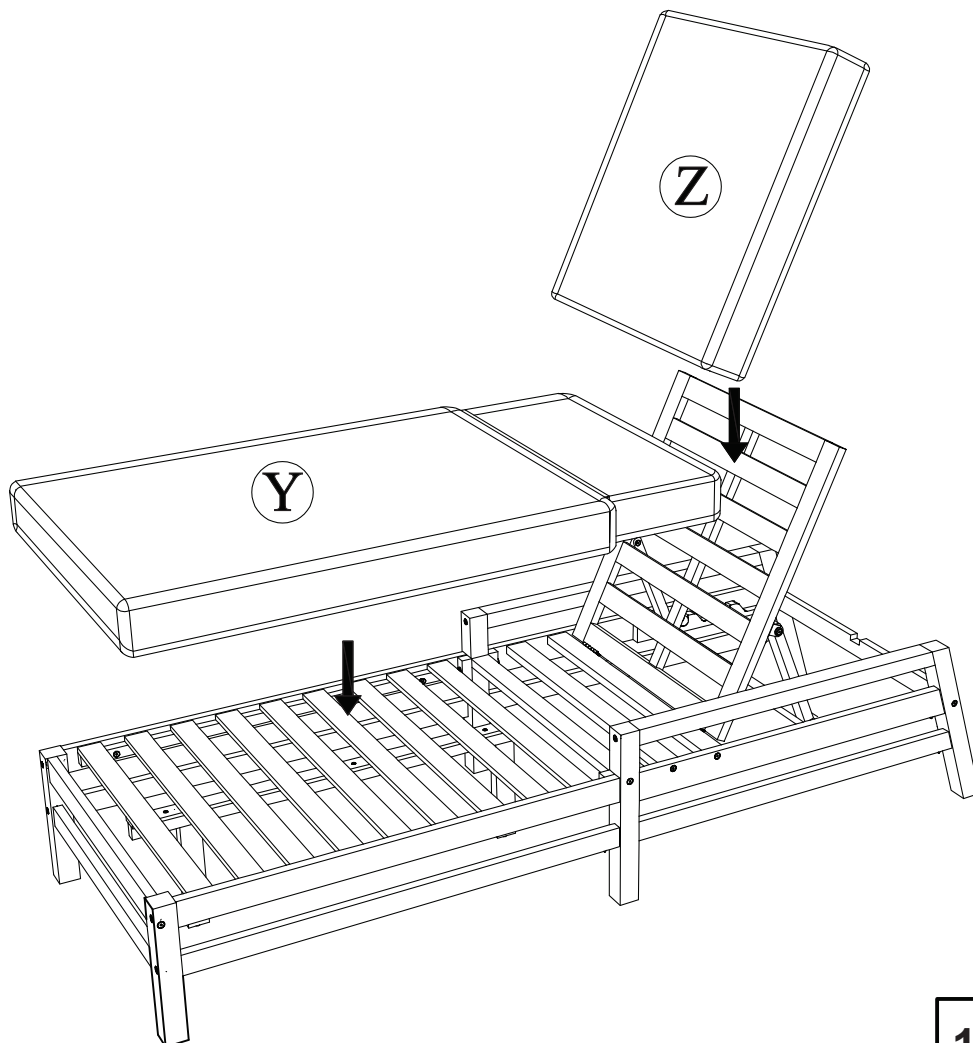

STEP 13

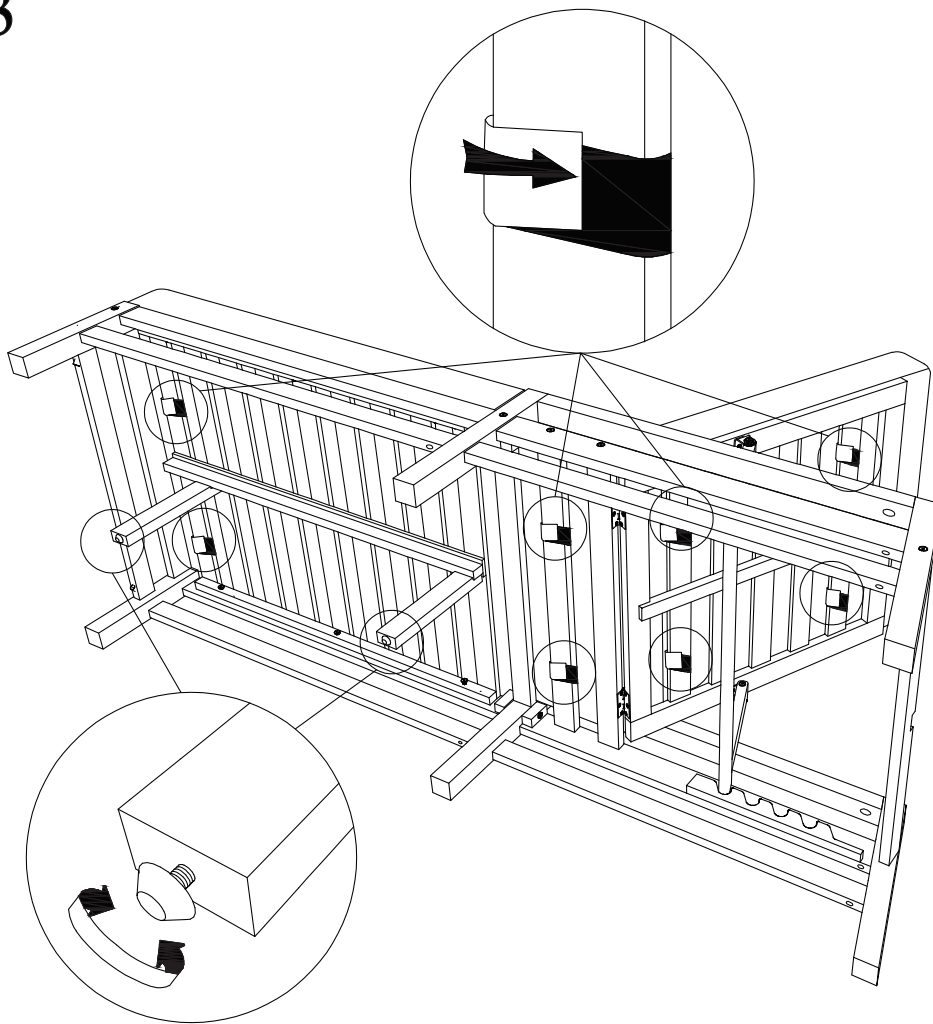

STEP 14

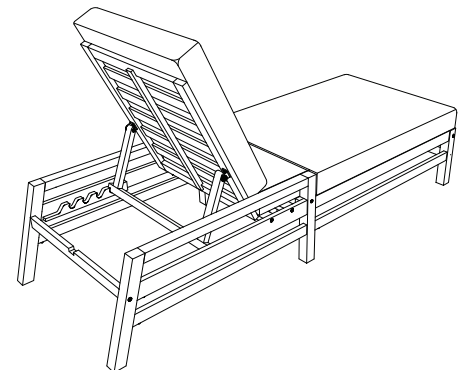
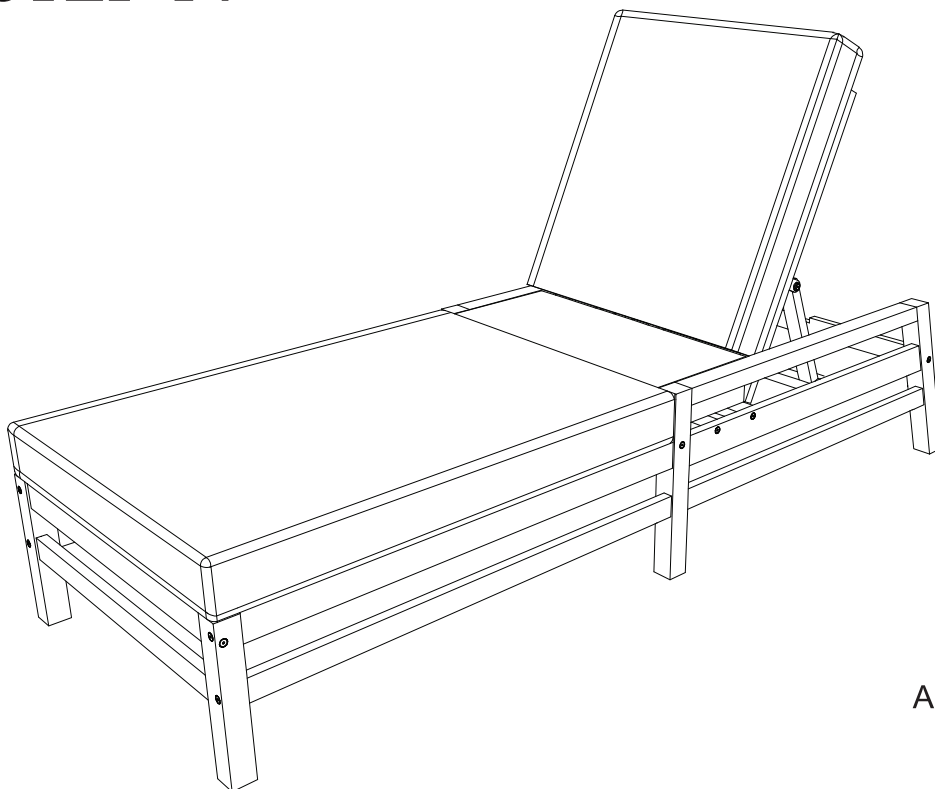

Adjust lever to set the backrest angle

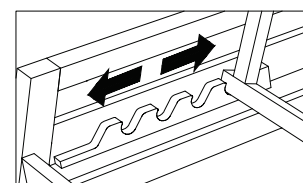

FINISH